



C A T A L O G O / C A T A L O G U E

2024



*Sempre di più / More and more*

ITA ENG





 **MEDIAL**  
INTERNATIONAL  
**METALNOVA**







## PROFILO AZIENDALE

### Specialisti del cleaning dal 1985

Medial International - Metalnova® è una delle grandi protagoniste italiane nel settore dell'igiene e della pulizia professionale. Una realtà dinamica ed in continua evoluzione, il cui impegno è costantemente rivolto allo sviluppo di prodotti che contribuiscano a migliorare la qualità degli spazi di vita, lavoro e svago, per accrescere il benessere e la salute di tutti coloro che li frequentano.

### Con noi puoi scegliere

Da oltre trent'anni realizziamo soluzioni coordinate per il decoro degli ambienti e la cura della persona. Un'offerta che si qualifica per versatilità ed estensione, con oltre 1000 prodotti a catalogo che spaziano dai sistemi per la gestione dei rifiuti alle attrezzature per la pulizia dei locali, dagli accessori per l'igiene pubblica a quelli d'uso personale, sino ad includere i complementi per spazi interni ed attrezzature per esterni.

## COMPANY PROFILE

### Cleaning specialist since 1985

Medial International - Metalnova® is a dynamic Italianbased company operating in the field of hygiene and professional cleaning since 1985. Our efforts are constantly focused on bringinginnovative products aimed at improving both the accessibility and the environmental quality of private, public and commercial places, to enhance people's health and wellbeing.

### Your choice with us!

With this goal clear in mind, we have been developing a wide and comprehensive offering to better serve the needs of our customers. Our assortment consists in more than 1000 items and comprises four main ranges, including waste management solutions, cleaning equipment, washroom dispensing systems, as well as equipment for indoor and outdoor areas.



Gestione dei rifiuti  
e pulizia dei locali  
*Waste management  
& cleaning solutions*



Attrezzature  
per spazi esterni  
*Equipment for  
outdoor areas*



Igiene e cura  
della persona  
*Hygiene and personal  
care solutions*



Attrezzature  
per spazi interni  
*Equipment for  
indoor areas*



LA NOSTRA STORIA

OUR HISTORY

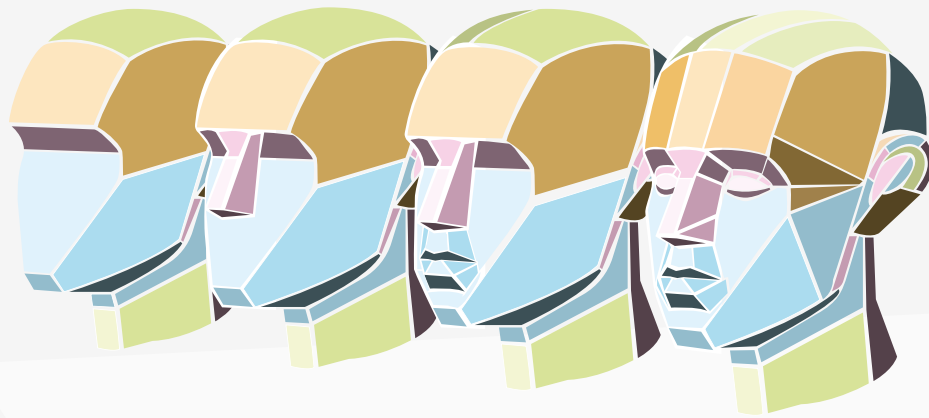

**afidampFAB**  
ASSOCIAZIONE ITALIANA FABBRICANTI MACCHINE PRODOTTI  
ATTREZZI PER LA PULIZIA PROFESSIONALE E L'IGIENE AMBIENTALE

Medial International-Metalnova è membro Afidamp (Associazione dei Fabbricanti e Distributori Italiani di Macchine, Prodotti e Attrezzi per la Pulizia Professionale e l'Igiene degli ambienti).

Medial International-Metalnova is Afidamp's member - the Italian Association of Manufacturers of Machinery, Products, and Tools for Industrial Cleaning and Environmental Hygiene.



1985

**NASCE MEDIALINTERNATIONAL** come filiale italiana di un'importante società francese di prodotti per l'igiene e la pulizia professionale  
**MEDIALINTERNATIONAL IS BORN** as the Italian subsidiary of a major French company of professional hygiene and cleaning products

METALNOVA

2008

**PROSEGUE IN AUTONOMIA IL PROPRIO CAMMINO E ACQUISISCE METALNOVA®** specializzandosi nella realizzazione di contenitori e pattumiere  
**CONTINUES INDEPENDENTLY ITS OWN PATH AND ACQUIRES METALNOVA®** specialising in the manufacture of containers and dustbins

2012

Una forte crescita amplia la gamma dei prodotti raggruppati in **4 GRANDI CATEGORIE:**  
LA GESTIONE DEI RIFIUTI  
L'IGIENE E LA CURA DELLA PERSONA  
I COMPLEMENTI PER GLI SPAZI INTERNI  
LE ATTREZZATURE PER LE AREE ESTERNE

A period of significant growth expanded the product assortment divided into

**4 MAIN CATEGORIES:**  
WASTE MANAGEMENT  
HYGIENE AND PERSONAL CARE PRODUCTS  
ACCESSORIES FOR INDOOR AREAS  
EQUIPMENT FOR OUTDOOR AREAS



In occasione del **30° ANNIVERSARIO RESTYLE DEL LOGO** il fiore a quattro petali ciascuno rappresentante una delle 4 famiglie di prodotti

Marking the company's **30TH ANNIVERSARY A BRAND-NEW ICON** takes shape, the four petals flower, each representing one of the business segments we deal with

2015

2020

**DUE SITI PRODUTTIVI IN ITALIA, UN CENTRO DI SVILUPPO INTERNO E UN MAGAZZINO DI OLTRE 10.000 M<sup>2</sup>** con circa 350.000 PEZZI, distribuiti in **OLTRE 20 PAESI.**  
**TWO PRODUCTION SITES IN ITALY, AN IN-HOUSE R&D CENTRE AND A WAREHOUSE OF OVER 10,000 M<sup>2</sup>** with approximately 350,000 PIECES, distributed in **MORE THAN 20 COUNTRIES**

**I PILASTRI PER IL FUTURO VERTONO SU 2 FRONTI:**  
**DIGITALE**, tramite **MEDIAL APP!** un'applicazione che ci permette di aggiornare i clienti sulle attività e novità oltre che fornire l'esperienza AR e VR  
**ECOLOGICO** grazie all'impegno verso la sostenibilità, implementando **2 IMPIANTI FOTOVOLTAICI** e diverse gamme prodotto "green", in **PLASTICA RICICLATA** e/o con **CERTIFICAZIONE PSV**



**FOR THE FUTURE WE'RE FOCUSING ON TWO MAIN SUBJECTS:**  
**DIGITAL**, through **MEDIAL APP!** an application that allows us to update customers on activities and news as well as provide AR and VR experiences  
**ECOLOGICAL**, thanks to our commitment to sustainability, by implementing **2 PHOTOVOLTAIC INSTALLATIONS** and several 'green' product ranges, in **RECYCLED PLASTICS** and/or with **PSV CERTIFICATION**



2016

Viene inaugurato il nuovo centro direzionale e logistico di **MULAZZANO (LO)** con un parco prodotti che include **OLTRE 1.200 REFERENZE**  
Nello stesso anno, la Società consegue la **CERTIFICAZIONE DI QUALITÀ ISO9001**

The company also celebrates the opening of its brand-new headquarter at **MULAZZANO (LO)** with a product range that includes **OVER 1,200 REFERENCES**  
In the same year, the company achieves **ISO9001 QUALITY CERTIFICATION**



2023

2024



**STUDIO & PROGETTAZIONE**

Le attività di studio, progettazione e sviluppo dei prodotti sono svolte internamente dal nostro ufficio tecnico. Un percorso approfondito con attenzione per dar vita a soluzioni innovative in cui forma e funzione trovino perfetta sintesi. Ideare per noi significa pensare ai più piccoli dettagli, migliorare le prestazioni e la qualità del prodotto, ottemperare a tutte le normative e agli standard vigenti. Una sensibilità creativa volta altresì ad esaltare il valore del design italiano, di cui sono espressione la maggior parte dei nostri prodotti.

**CONCEPT & DESIGN**

The research and development of each of our items is run internally by our technical department through a process focused on creating innovative solutions, where form and function find the perfect combination. For us, design also means rethinking the smallest details in order to improve the performance and quality of the product in order to comply with all applicable regulations and standards in force. Attention in research is also focused on the Italian design values, of which most of our products are the expression.

**PRODUZIONE**

Abbiamo consolidato la nostra realtà inseguendo un costante miglioramento nell'efficienza produttiva. Due siti in Italia, diversificati per tipologia di macchinari ed expertise, ci consentono di ottimizzare i processi e rispondere con flessibilità alle richieste di un mercato in continuo mutamento. Siamo altresì in grado di realizzare pezzi su misura ed articoli personalizzati in funzione delle specifiche esigenze del cliente. Una cura sartoriale per offrire un prodotto che intercetti al meglio le esigenze del vivere contemporaneo.

**PRODUCTIONS**

Medial International has consolidated its manufacturing capacity pursuing a constant improvement in production efficiency. Two sites in Italy, diversified by type of machinery and expertise, allow to optimize production processes and implement timely changes to the molds. The ability to customize products, thanks to sophisticated technologies, is undoubtedly one of our strengths, enabling us to accommodate each request and propose the best solution to our customers.

**QUALITÀ CERTIFICATA**

Realizzare prodotti che contribuiscano a migliorare la salute e il benessere delle persone nei loro spazi di vita, lavoro e svago è la direttrice lungo la quale si snoda la nostra attività d'impresa. La missione sulla base della quale abbiamo costruito la nostra identità. Valori che trovano espressione pratica nell'adozione di un sistema di gestione di qualità dei processi interni conforme ad un modello certificato e riconosciuto a livello internazionale - la certificazione UNIEN ISO 9001 - conseguita nel 2016.

**CERTIFIED QUALITY**

We are committed in offering products that help people improve the quality of their lives in any space of living at home, at work as well as in leisure spaces. This guiding value is at the bases of our business approach and represents the cornerstone on which our company has built its identity. In view of this and most of all as an instrumental part of our strategy, Medial International adopted a Quality Management System certified under UNI EN ISO 9001 in 2016.







### **LOGISTICA**

La logistica è da sempre uno dei nostri punti di forza. Disponiamo di oltre 10.000 mq di deposito coperto in cui sono stoccati oltre 350.000 pezzi. Siamo quindi in grado di gestire regolari flussi di merci in approvvigionamento e rispondere con tempestività alle richieste d'evasione degli ordini di vendita. Un'attenta pianificazione delle consegne ed una solida partnership con spedizionieri qualificati, ci permette altresì di garantire consegne puntuali ed efficienti.

### **LOGISTIC**

Logistics has always been one of our strengths. We have over 10,000 square meters of covered warehouses where over 350,000 pieces are stored. By using an advanced warehouse management system, we are therefore able to manage huge incoming flows of goods, then fulfilling customers' orders as quickly as possible. Thanks to a careful scheduling and strong partnerships with qualified shippers, we can guarantee timely and efficient deliveries.



### **RETE VENDITA**

La distribuzione dei nostri prodotti è affidata ad una capillare rete di rivenditori presenti in oltre 20 paesi. Nel corso degli anni abbiamo rafforzato la nostra presenza commerciale in Italia, per poi svilupparci con lo stesso approccio in Francia, Germania e in gran parte dei paesi europei. Un modello che si va via via espandendo in un network sempre più globale, che trova sbocchi commerciali persino in Medio Oriente, Africa e Asia. Il tutto al fine di creare un vero e proprio sistema di interfaccia con l'utilizzatore finale, affidato a professionisti di grande esperienza, in grado di garantire un valore che per noi è indispensabile: l'assistenza prima, durante e dopo l'acquisto del prodotto.

### **SALES NETWORK**

The distribution of our products is in fact carried out by a network of distributors in more than 20 countries.

Over the years we have first aimed to strengthen our commercial coverage in Italy then grow with the same approach in France, Germany and in most European countries.

A model that has gradually expanded, finding business market opportunities even in the Middle East, Africa and Asia. All this effort in order to create a real interface with the end-user, entrusted to highly experienced professionals, able to guarantee a value that is essential for us: the support before, during and after the purchase of our products.

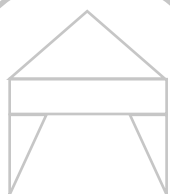
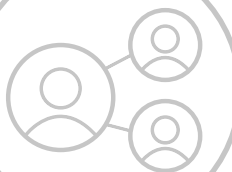

### **FIERE ED ESPOSIZIONI**

Partecipiamo alle manifestazioni fieristiche più importanti per il mondo del cleaning, come INTERCLEAN di Amsterdam, EUROPROPPE di Parigi e PULIRE di Verona. Appuntamenti imperdibili, che hanno permesso di dare un'immagine coordinata della nostra azienda, rendendo i nostri prodotti sempre più conosciuti ed apprezzati.

### **FAIRS AND EXHIBITIONS**

We attend the most important trade shows for the world of professional cleaning, as "INTERCLEAN" in Amsterdam, "EUROPROPPE" in Paris and "PULIRE" in Verona. These unmissable events allow us to give a corporate image, making our products more and more popular and appreciated.





DIAMO FORMA ALLE TUE IDEE

WE GIVE SHAPE TO YOUR IDEAS

Offriamo ai nostri clienti l'opportunità di personalizzare un'ampia gamma di prodotti con scritte, loghi o altri elementi grafici distintivi. Per soddisfare al meglio le esigenze dei committenti, utilizziamo tecniche avanzate ed innovative, scelte in funzione del tipo di applicazione da eseguire.

Medial International offers its customers the opportunity to customize a wide range of its products with slogans, logos or other distinctive graphics. To better meet the needs of customers, we use advanced and innovative techniques, chosen depending on the type of application to be performed.



#### **STAMPA TAMPOGRAFICA**

La tampografia adotta un sistema a lastra, con un tampone più o meno morbido che preleva l'inchiostro dalla piastra incisa (cliché) e lo riporta direttamente sulla superficie dell'oggetto "tamponandolo" con la stampa desiderata. A differenza di altre tecniche di stampa, la tampografia garantisce risultati eccellenti su superfici irregolari o sferiche, anche per scritte molto piccole. È altresì apprezzata dove è richiesta la stampa multicolore e dov'è necessaria rapidità di essiccazione. Tra i vari vantaggi offerti si annovera anche l'economicità: non essendo necessaria la costruzione di un telaio, la tampografia risulta più economica in termini di costo d'impianto.

#### **PAD PRINTING**

Pad printing uses a plate system, with pads varying in softness that pick up the ink from the engraved plate and bring it directly to the surface of the object and "dabbing" it with the desired print.

Unlike other printing techniques, pad printing provides excellent results on irregular or spherical surfaces, even with very small print. It is

also appreciated where multi-coloured printing is required and fast drying is needed. Finally, the various advantages include its economical cost: as the construction of a frame is not required, its installation costs are cheaper.

#### **STAMPA SERIGRAFICA**

La serigrafia consiste nel far filtrare un colore attraverso una tela precedentemente "foto-esposta" allo scopo di trasferire il progetto grafico su di essa. L'oggetto da personalizzare viene quindi posto immediatamente a contatto con la tela, fissata direttamente ad un telaio in metallo.

È possibile realizzare grafiche in tinta unita al tratto per uno o più colori di stampa. I vantaggi della serigrafia sono sostanzialmente tre. Consente di trasferire spessori molto elevati di inchiostro, anche con possibilità di rigonfiamento previo utilizzo di appositi additivi, ottenendo dei risultati di stampa al quanto resistenti all'abrasione e alla luce. Garantisce una resa ottimale dei colori, in quanto questi vengono stampati in successione. Da ultimo, consente di operare anche su materiali non assorbenti e superfici non perfettamente lisce.

#### **SCREEN PRINTING**

Screen printing consists in filtering a colour through a previously "photo-exposed" canvas in order to transfer a graphic design onto it. The object to customize is then placed immediately in contact with the canvas, which is fixed directly to a metal frame. You can create plain coloured line-drawn graphics in one or more print colours. Screen printing basically has three advantages. It lets you transfer a large thickness of ink, even with the possibility of swelling subject to use of special additives, to obtain print results that are resistant to abrasion and light. It ensures optimal colour rendering, as the colours are printed in succession. Finally, it also allows you to work on non-absorbent materials and surfaces that are not perfectly smooth.



#### **DIGITAL TRANSFER**

Come suggerito dal nome, il transfer consiste in una tecnica di stampa a trasferimento termico. La grafica viene stampata in digitale su una pellicola transfer per poi venir applicata con una speciale pressa a caldo direttamente sull'articolo da personalizzare.

I vantaggi di questa tecnica sono sostanzialmente due.

La qualità della stampa risulta eccellente anche per le quadricromie, in quanto fornisce immagini ad elevata risoluzione, con combinazioni cromatiche nitide e brillanti. Da ultimo, si tratta di una tecnica rapida ed economica soprattutto per le basse tirature, in quanto non necessita di lastre o allestimento di impianti quali telai pellicole o clichés.

#### **DIGITAL PRINTING**

As the name suggests, digital printing consists in a heat transfer printing technique. The graphics are printed digitally on a transfer film and then applied with a special hot press directly on the item to be customized. The advantages of this technique are essentially two. The print quality is excellent, even with the four-colour process, as it provides high-resolution images with brilliant, vibrant colour combinations. Finally, it is a quick and inexpensive technique, especially for short runs, as it does not require plates or setting up installations such as film frames or stereotypes.

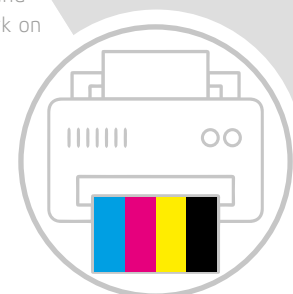
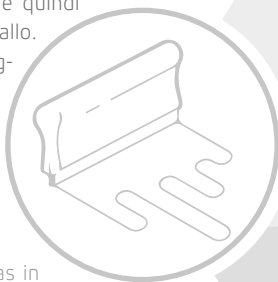
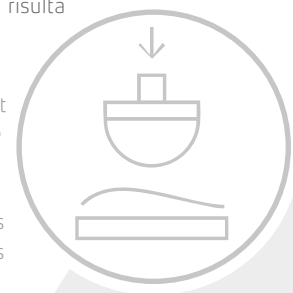

## PERSONALIZZAZIONE LASER

## LASER CUSTOMIZATION

Quando un prodotto è sottoposto ad incisione con laser 3D, la sua superficie viene colpita da un sottile raggio che asporta gli strati superiori del materiale, creando un sottile intaglio. La qualità della lavorazione è massima, l'esecuzione estremamente rapida ed i costi di realizzazione molto contenuti.

Laser engraving is an innovative and quick method of permanently marking contents on products. It consists in a non-contact process where the laser beam removes the surface of the material to expose a cavity. The cavity reveals an image that is noticeable to the eye and touch.

### **LAVORAZIONI AD HOC**

È possibile riprodurre qualunque elemento grafico (loghi, codici, testi, motivi ornamentali). La misura massima della lavorazione è di 15x15 cm. Per effettuare l'incisione è necessario fornire un file vettoriale con estensione .dxf, .dwg oppure .ai (Illustrator 8). Nel caso si disponga di file con estensioni diverse, potranno comunque essere convertiti. I costi di questa operazione saranno oggetto di preventivo.

### **100% CUSTOMIZABLE**

Laser engraving offers almost unlimited possibilities in terms of marking contents. It allows customized marking of logos, codes, texts, shapes as well as any other graphic element. The maximum marking size is 15x15 cm. You will be asked to provide your contents in vector format (.dxf, .dwg or .ai Illustrator 8 file). Other file formats can be converted. Conversion costs will be quoted on demand.

### **TEMPI E COSTI RIDOTTI**

La marcatura con laser 3D è nota per la velocità d'esecuzione. I tempi sono indicativamente 10 giorni, variabili in funzione dell'articolo scelto e della quantità da personalizzare. Questa lavorazione si rivela ideale anche per questioni di budget, in quanto non comporta costi d'impianto e può essere utilizzata per personalizzare anche piccoli lotti di produzione.

### **QUICK AND COST-EFFECTIVE**

The 3D laser engraving provides an extremely fast way to customize your products. Processing time is approximately 10 days, although this may vary depending on the number of item to be processed. It is also cost-effective since it operates almost entirely without consumable materials and does not require special installations. So, this method is ideal to customize even small product batches.

### **PRECISIONE E QUALITÀ**

L'incisione laser 3D vanta una qualità esecutiva ed un valore estetico superiori rispetto alle tradizionali tecniche di stampa. Consente infatti di riprodurre con straordinaria precisione elementi grafici anche di minime dimensioni, garantendo dettagli accurati e risultati uniformi.

### **PRECISION & HIGH QUALITY**

The 3D laser engraving quality is unmatched for reproducing graphics. The mark is precise, since no part of the machinery actually touches the material being engraved. Furthermore, it gives highly detailed marks, without adding undesirable substances. So, this technology is ideal to engrave even the smallest shapes.

### **FLESSIBILITÀ**

L'incisione con laser 3D consente di ottenere risultati ottimali su un'ampia tipologia di forme e materiali. È eseguibile sui prodotti in metallo, acciaio inox e abs, con riserva di verifica in funzione del prodotto, del tipo di materiale, del tipo di verniciatura e del relativo colore.

### **FLEXIBILITY**

You can laser engrave a wide variety of materials including, plastics, stainless steel and other metals. It can also be used to engrave coated materials, although this is subject to verification depending on the kind of product as well as the colour and coating type.

### **INDELEBILE NEL TEMPO**

La personalizzazione con laser 3D è permanente ed indelebile, non soggetta al rischio di scolorimento, deterioramento o deformazione.

### **PERMANENT MARKING**

Since the 3D laser engraving works on the top of the material, it leaves a permanent mark capable of withstanding harsh environments, without deforming and discolouring.

### **TONALITÀ CROMATICHE**

La personalizzazione con laser 3D non è eseguibile a colori. La tonalità cromatica della lavorazione dipende infatti dalla composizione del materiale da incidere.

### **COLOURS**

Laser engraving does not transmit color but it can change the color of the engraved item.







ISTRUZIONI APPLICAZIONE STICKERS  
INSTRUCTIONS FOR APPLYING STICKERS



**1** Prima di iniziare, pulire bene la superficie interessata con una soluzione alcolica.  
Before starting, clean the surface with an alcohol solution.

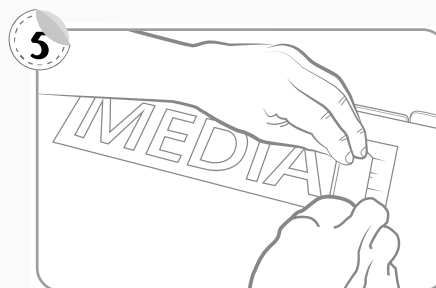

**5** Utilizzando una spatola (o un righello) far aderire l'adesivo alla superficie.  
By using a spatula (or a ruler) let the sticker adhere to the surface.

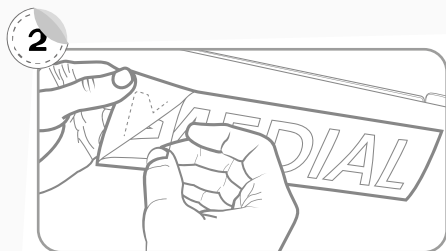

**2** Rimuovere la pellicola superiore.  
Remove the upper film.

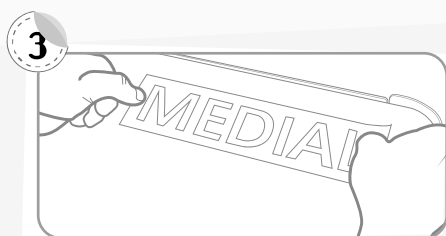

**3** Applicare l'adesivo.  
Apply the sticker.

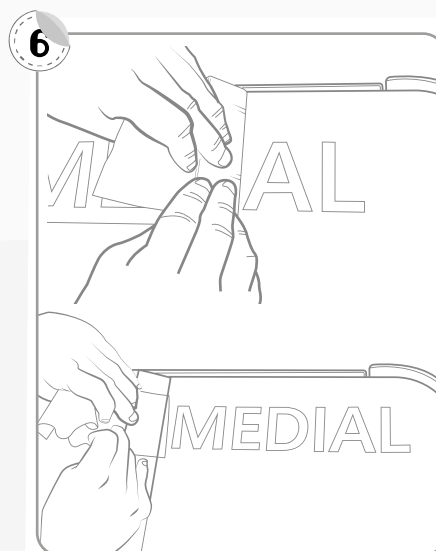

**6** Facendo attenzione che le lettere (o i pittogrammi) rimangano incollati alla superficie, rimuovere lentamente tutta la pellicola trasparente.  
Be careful that letters (or pictograms) should be kept stuck to the surface while slowly removing the transparent film.

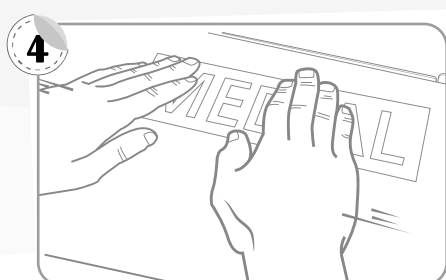

**4** Per evitare pieghe o bolle d'aria distendere l'adesivo aiutandosi con le mani.  
To avoid creases or air bubbles, stretch the adhesive with the help of your hands.



SCANSIONA IL QR CODE E GUARDA  
IL VIDEO TUTORIAL  
SCAN THIS QR CODE TO SEE THE VIDEO TUTORIAL

## I NOSTRI PARTNERS

## OUR PARTNERS

# 3M

Cresce e si rafforza in maniera significativa la **partnership** commerciale in ambito **Cleaning & Workplace Safety** tra **3M**, multinazionale americana leader e presente in tutto il mondo e **Medial International**, azienda italiana leader nel settore delle forniture professionali per il cleaning, **Distributore Autorizzato 3M**.

Obiettivo sfidante è quello di consolidare la sinergia di una partnership forte volta ad accrescere/potenziare il processo congiunto di crescita commerciale iniziato nel 2016 nell'ambito della **pulizia professionale, della manutenzione e della sicurezza**, con in più un nuovo focus specifico sullo sviluppo di settori complementari e affini al Cleaning come quello delle **ferramenta**, marine e più in generale tutto il mondo dell'industria oltre alla grande distribuzione.

The commercial **partnership** in the Cleaning & Workplace Safety field between **3M**, a leading American multinational company and **Medial International**, an Italian company leader in the field of professional supplies for cleaning, also recognized as **3M Authorized Distributor is growing and strengthening significantly**.

The challenging objective is to consolidate the synergy of a strong partnership aimed at increasing/enhancing the joint business growth process started in 2016 in the field of **professional cleaning, maintenance and safety**, with in addition a new specific focus on the development of complementary sectors and similar to Cleaning such as that of **hardware**, marine and more generally the whole world of industry in addition to large-scale distribution.

The challenging objective is to consolidate the synergy of a strong partnership aimed at increasing/enhancing the joint business growth process started in 2016 in the field of **professional cleaning, maintenance and safety**, with in addition a new specific focus on the development of complementary sectors and similar to Cleaning such as that of **hardware**, marine and more generally the whole world of industry in addition to large-scale distribution.

### 3M™ Scotch-Brite™ Dischi

Dischi in fibra per macchine lavapavimenti  
*Scrubber dryers floor brush.*



### 3M™ Nomad™ Tappeti

Tappeti ingresso  
*Entrance matting*



### 3M™ Safety-Walk™

Prodotti antiscivolo  
*Anti-slip products*



### 3M™ Scotch-Brite™ Panni

Panni in Microfibra  
*Microfibre Wipes*



### 3M™ Scotch-Brite™ Accoppiati

Accoppiato spugna  
*Scouring Sponge*

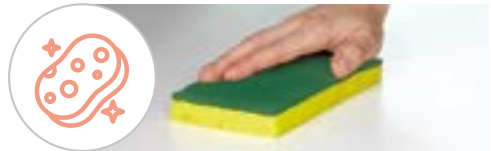

### 3M™ Scotch-Brite™ Fibre

Fibra verde  
*Scouring Pad, Green*



### Dal 2021, la nostra divisione chimica Since 2021, our chemical division

Azienda chimica fondata nel 1999, specializzata nella produzione di detersivi e profumatori professionali per ambienti industriali, HO.RE.CA., cleaning sanitario, industria alimentare, bagni mobili, nautica, mezzi di trasporto.

Chemical company founded in 1999, specialized in the production of professional detergents and perfumers for industrial environments, HO.RE.CA., sanitary cleaning, food industry, portable toilets, boating, means of transport.



LO SGUARDO AL FUTURO

LOOKING FURTHER AHEAD

**MEDIAL SEMPRE CON TE “A PORTATA DI TOUCH”!**  
**“MEDIAL IS ALWAYS WITH YOU AT YOUR FINGERTIPS !**



**MEDIAL APP**

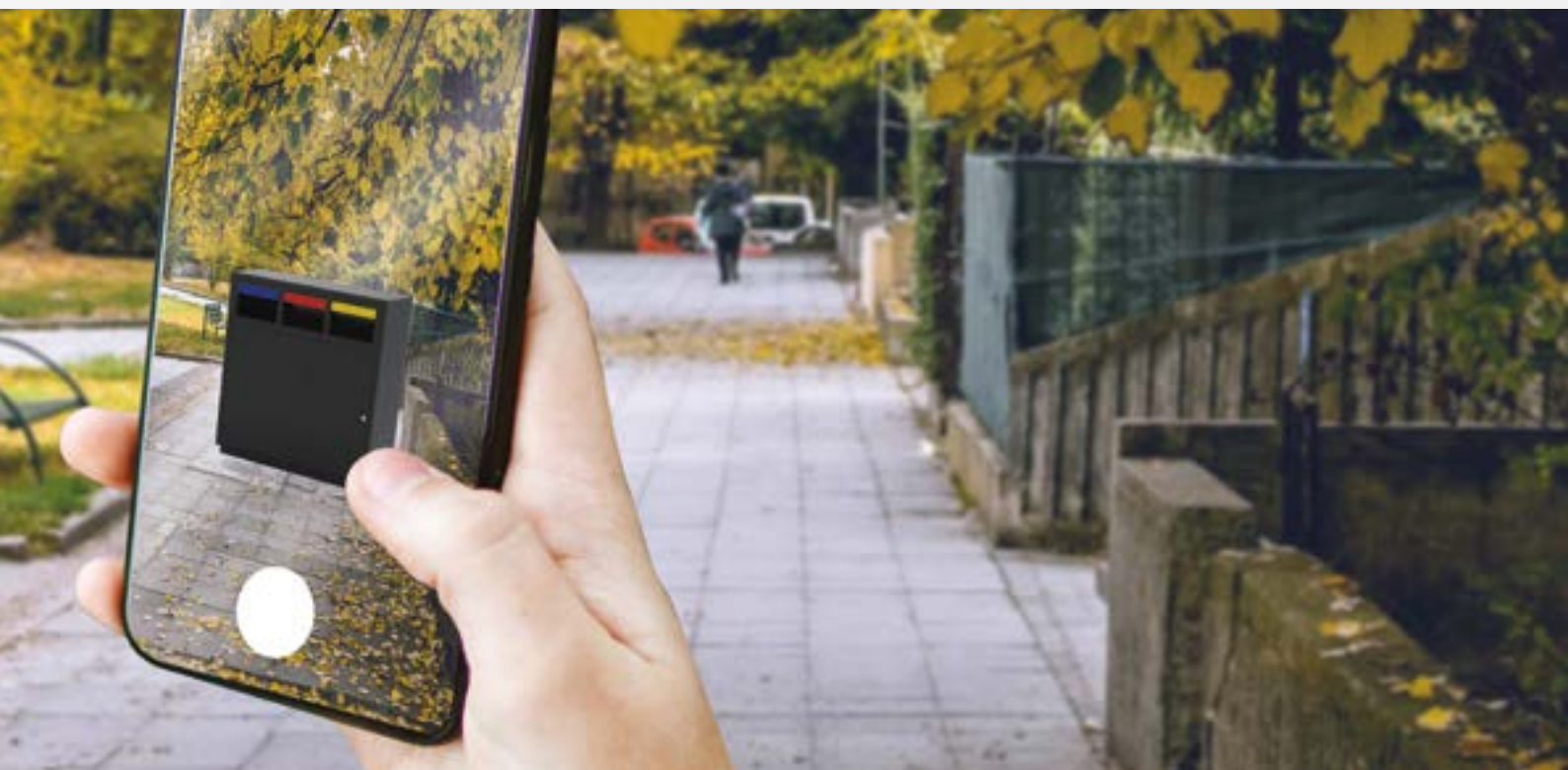

*SCARICA L'APP SUI TUOI DISPOSITIVI*  
*DOWNLOAD MEDIAL APP TO YOUR DEVICES*



LO SGUARDO AL FUTURO

LOOKING FURTHER AHEAD

**ANCHE MEDIAL SI IMMERGE NELLA MAGIA VIRTUALE!  
FOLLOW MEDIAL AND IMMERSE YOURSELF INTO VIRTUAL MAGIC!**

Per ritrovarci sempre più vicino ai nostri clienti, abbiamo concepito un'applicazione che coniuga la possibilità di essere sempre aggiornati e informati sulle nostre attività, con l'esperienza virtuale interattiva da vivere con i nostri prodotti.

In order to be closer and closer to our customers, we have designed an application that combines the possibility of always being up-to-date and informed about our activities with an interactive virtual experience to live with our products

**STORIES**

Per rimanere sempre informati  
To be always informed

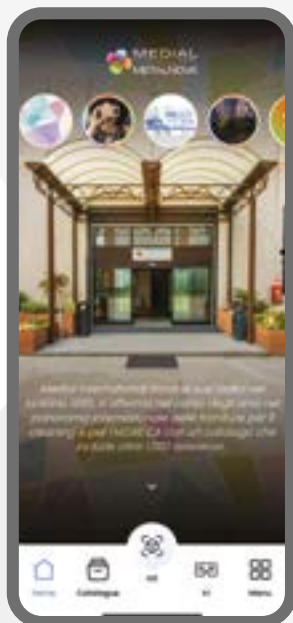

**Catalogue**

- 2023 General Catalogue →
- 2023 Novelties Catalogue →
- All Catalogue →

**CATALOGHI - CATALOGUES**

Scarica i nostri cataloghi  
e le schede tecniche  
Download our catalogues  
and data sheets

**AR**

Scopri a Catalogo quali prodotti sono disponibili per l'esperienza della realtà aumentata  
Discover in the Catalogue which products are available for augmented reality experience



**Virtual Reality**



**VR**

Immergiti negli ambienti della realtà virtuale  
Immerse yourself into virtual reality environments

**INQUADRA IL QR CODE E GUARDA IL VIDEO PER SCOPRIRE DI PIÙ  
FRAME THE QR CODE AND WATCH THE VIDEO TO FIND OUT MORE**

**VIDEO TUTORIAL**







**MEDIAL PENSA "IN VERDE" GRAZIE ALL'IMPIANTO FOTOVOLTAICO!  
MEDIAL IS ECOLOGICALLY MINDED THANKS TO PHOTOVOLTAIC SYSTEM!**



POTENZA MASSIMA  
MAXIMUM POWER

**140kW**  
(60kW + 80kW)



ENERGIA PRODOTTA  
RIUTILIZZABILE  
REUSABLE  
ENERGY GENERATED

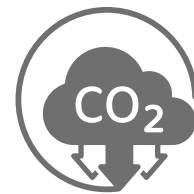

CO<sub>2</sub> RISPARMIATA  
SAVING CO<sub>2</sub>

Medial ha compiuto diversi passi orientati verso la sostenibilità. Tra le varie azioni intraprese è stato decretato un investimento nell'**impianto fotovoltaico** con l'obiettivo di *produrre energia elettrica "pulita"*. Una decisione volta al rispetto dell'ambiente e che comporta una netta riduzione della propria impronta di carbonio. Grazie all'impianto fotovoltaico, Medial può garantirsi la concreta possibilità di **diminuire le emissioni di gas serra**, rendendosi in piccola parte protagonista della diffusione delle fonti di energia rinnovabile, promuovendo così un *impatto positivo nel settore dell'energia green*.

Medial has taken several steps towards sustainability. Among the various actions taken it was decided to invest in the **photovoltaic system** with the aim of *producing electricity "clean"*. A decision aimed at respecting the environment and which entails a significant reduction in its carbon footprint. Thanks to the photovoltaic system, Medial can guarantee the concrete possibility of **reducing greenhouse gas emissions**, making it a small part of the diffusion of renewable energy sources, thus promoting a *positive impact in the green energy sector*.



LA PLASTICA RICICLATA SEMPRE PIÙ PROTAGONISTA  
RECYCLED PLASTIC TAKES THE LEAD



Medial persegue il suo impegno nella continua ricerca di soluzioni innovative che enfatizzino l'aspetto green nel **rispetto dell'ambiente** e con la mission di soddisfare al meglio le **esigenze dei propri clienti**. Assume quindi una forte rilevanza una delle novità principe del 2024, la gamma di prodotti **PSV (Plastica Seconda Vita)**, scelta che garantisce un nuovo investimento per sostenere una filiera produttiva e logistica volta a salvaguardare il mondo che ci circonda. Medial punta quindi sempre sull'utilità coniugata all'estetica anche nella nuova linea di prodotti PSV introdotta oltre alle già "arruolate" ECOCONTI, STILECO, ECO RIF e BASKET.

Medial pursues its commitment in the continuous search for innovative solutions that emphasize the green aspect while **respecting the environment** with the goal of satisfying its customers' needs in the most suitable way. One of the main Medial novelties of 2024, results to be **PSV (Plastic Second Life)** products. This choice guarantees a new investment to support a production and logistic chain aimed at safeguarding the world around us. Medial highlights both efficiency and aesthetics also in the new sustainable ranges introduced in the catalogue in addition to the already "enlisted" ECOCONTI, STILECO, ECO RIF and BASKET.

ECOCONTI



STILECO



ECO RIF BASKET



plastic  
second life



L'Istituto **Promozione Plastiche Riciclo (IPPR)** è stato il primo a istituire, in Italia e in Europa, la certificazione **PSV Plastica Seconda Vita**, "un'etichetta ecologica per materiali e prodotti in plastica riciclata" (citazione fonte: [www.ippr.it](http://www.ippr.it)). Si tratta di una certificazione ambientale che valorizza i prodotti provenienti dal riciclo di rifiuti plastici domestici e post-industriali, enfatizzando quindi **la qualità e la rintracciabilità dei materiali riciclati** (riferimento norma UNI EN ISO 14021 e al DM attuativo 203/2003 relativo al GREEN PUBLIC PROCUREMENT).

La virgola nel logo assume il preciso dovere di evidenziare la doppia vita del manufatto in plastica passando dalla sua prima vita al rifiuto per rinascere a seconda vita grazie al processo di riciclo per diventare un nuovo prodotto, contribuendo così ad alimentare il **ciclo di economia circolare**.

The **Institute for the Promotion of Plastics Recycling (IPPR)** was the first in Italy and Europe to establish the PSV Plastics Second Life certification, 'an eco-label for recycled plastic materials and products' (source quote: [www.ippr.it](http://www.ippr.it)). This is an environmental certification that enhances products from the recycling of household and post-industrial plastic waste, thus emphasizing **the quality and traceability of recycled materials** (reference to UNI EN ISO 14021 standard and implementing DM 203/2003 on GREEN PUBLIC PROCUREMENT).

The comma in the logo takes on the precise duty of highlighting the double life of the plastic artefact, going from its first life to waste to be reborn to a second life thanks to the recycling process to become a new product, thus contributing to feeding the **circular economy cycle**.

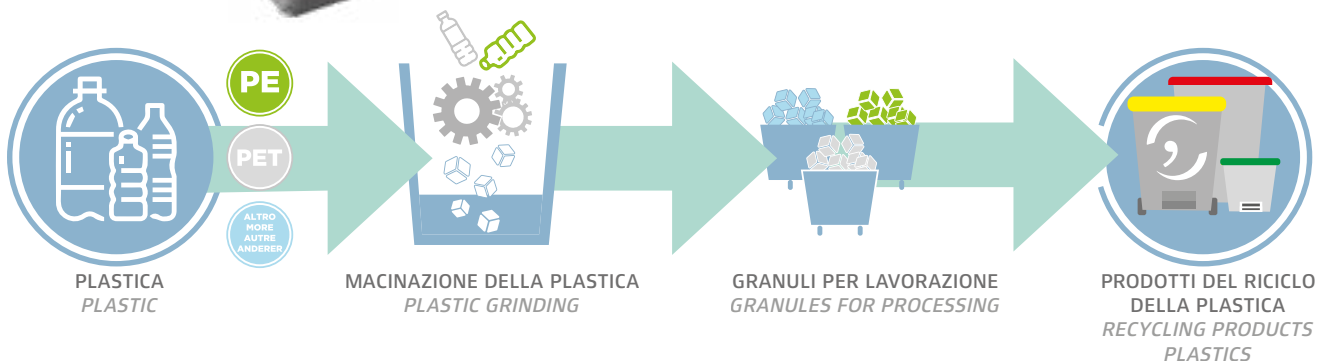

Tutti i prodotti PSV sono realizzati con materiali idonei e conformi alla certificazione dell'istituto IPPR ed immessi sul mercato rispettando tutte le normative di riferimento comunitario e italiano  
All PSV products are made of suitable materials and comply with IPPR institute certification and placed on the market in compliance with all relevant EU and Italian regulations





## GESTIONE DEI RIFIUTI E PULIZIA DEI LOCALI

### WASTE MANAGEMENT AND CLEANING SOLUTIONS

	CONTENITORI IN METALLO METAL WASTE CONTAINERS	<b>18</b>
	PORTASACCHI IN METALLO METAL SACK HOLDERS	<b>26</b>
	PATTUMIERE IN METALLO METAL PEDAL BINS	<b>28</b>
	CONTENITORI IN PLASTICA PLASTIC WASTE CONTAINERS	<b>30</b>
	BIDONI IN PLASTICA PLASTIC TRASH CANS	<b>40</b>
	PATTUMIERE IN PLASTICA PLASTIC BINS	<b>42</b>
	SISTEMI PER LA PULIZIA CLEANING SYSTEMS	<b>45</b>
	ETICHETTE PER LA RACCOLTA DIFFERENZIATA WASTE SORTING STICKERS	<b>46</b>
	PORTAROTOLI INDUSTRIALI INDUSTRIAL ROLL DISPENSERS	<b>48</b>
	ACCESSORI PER SPAZI ALIMENTARI EQUIPMENT FOR FOOD AREAS	<b>52</b>
	STERMINATORI D'INSETTI FLYING INSECT KILLERS	<b>53</b>
	DISABITUANTI DETERRENTS	<b>57</b>



## IGIENE E CURA DELLA PERSONA

### HYGIENE AND PERSONAL CARE SOLUTIONS

	LINEA SUPERB SUPERB RANGE	<b>61</b>
	LINEA BRINOX BRINOX RANGE	<b>67</b>
	LINEA PURA PURA RANGE	<b>80</b>
	LINEA NOIR NOIR RANGE	<b>84</b>
	LINEA BASICA BASICA RANGE	<b>92</b>
	LINEA WAVE WAVE RANGE	<b>102</b>
	LINEA WAVE <sup>2</sup> WAVE <sup>2</sup> RANGE	<b>104</b>
	LINEA STILECO STILECO RANGE	<b>106</b>
	DISTRIBUTORI CARTA IN BOBINE CENTER PULL TOWEL DISPENSERS	<b>110</b>
	FASCIATOI PER NEONATI BABY CHANGING TABLES	<b>114</b>
	ACCESSORI BAGNO SIMPLY SIMPLY BATHROOM ACCESORIES	<b>115</b>
	ACCESSORI BAGNO KATY KATY BATHROOM ACCESORIES	<b>116</b>
	SPECCHI MIRRORS	<b>118</b>
	ACCESSORI WC WC ACCESSORIES	<b>120</b>
	DIFFUSORI DI PROFUMO AIR FRESHENERS	<b>123</b>
	POSTAZIONI IGIENIZZANTI SANITIZING STATIONS	<b>132</b>
	PROTEZIONE INDIVIDUALE PERSONAL PROTECTIVE EQUIPMENTS	<b>136</b>
	MATERIALI DI CONSUMO CONSUMABLES	<b>139</b>
	KIT PRIMO SOCCORSO FIRST AID KITS	<b>143</b>
	ASCIUGAMANI ELETTRICI HAND DRYERS	<b>147</b>
	ASCIUGACAPELLI HAIR DRYERS	<b>165</b>



## ATTREZZATURE PER SPAZI INTERNI

EQUIPMENT FOR  
INDOOR AREAS

	GETTACARTE RACCOLTA DIFFERENZIATA RECYCLING WASTE BINS	176
	CONTENITORI RIFIUTI SPECIALI SPECIAL WASTE CONTAINERS	188
	GETTACARTE AUTO-ESTINGUENTI SELF EXTINGUISHING WASTE BINS	189
	ETICHETTE PER LA RACCOLTA DIFFERENZIATA WASTE SORTING STICKERS	192
	GETTACARTE PUSH PUSH WASTE BINS	194
	GETTACARTE BASCULANTI SWING WASTE BINS	196
	GETTACARTE TRASPARENTI TRANSPARENT WASTE BINS	197
	GETTACARTE MURALI WALL MOUNTED WASTE BINS	198
	CESTINI PAPER BINS	199
	POSACENERE GETTACARTE ASHBINS	203
	PORTAOMBRELLI UMBRELLA STANDS	207
	DISTRIBUTORE BUSTE COPRI-OMBRELLO UMBRELLA WRAPPER	208
	PANCHE SALE D'ATTESA RECEPTION SEATINGS	209
	SISTEMI DIVISORI CROWD CONTROL POSTS	210
	PITTOGRAMMI PICTOGRAMS	214
	APPENDIABITI COAT STANDS	216



## ATTREZZATURE PER SPAZI ESTERNI

EQUIPMENT FOR  
OUTDOOR AREAS

	POSTAZIONI RACCOLTA DIFFERENZIATA RECYCLING STATIONS	220
	POSACENERE-GETTACARTE ASHBINS	225
	POSACENERE ASHTRAYS	227
	GETTACARTE LITTER BINS	230
	DISPENSER SACCHETTI DEIEZIONI CANINE DOG WASTE BAGS DISPENSERS	235
	REGGISACCHI SACK HOLDERS	236
	CONTENITORI MOBILI PER ESTERNO OUTSIDE MOBILE BINS	240



GUIDA AI MATERIALI, ALLE LAVORAZIONI E ALLE FINITURE MATERIALS, PROCESSING AND FINISHINGS GUIDE	244
TRATTAMENTO DELLE SUPERFICI SURFACE TREATMENTS	248
PULIZIA E MANUTENZIONE CLEANING AND MAINTENANCE	249
PULIZIA E MANUTENZIONE DEI DISPENSER DISPENSERS CLEANING AND MAINTENANCE	250
LEGENDA - LEGEND	252





## GESTIONE DEI RIFIUTI E PULIZIA DEI LOCALI WASTE MANAGEMENT AND CLEANING SOLUTIONS

P. **18**  **CONTENITORI IN METALLO**  
*METAL WASTE CONTAINERS*

P. **45**  **SISTEMI PER LA PULIZIA**  
*CLEANING SYSTEMS*

P. **26**  **PORTASACCHI IN METALLO**  
*METAL SACK HOLDERS*

P. **46**  **ETICHETTE PER LA RACCOLTA  
DIFFERENZIATA**  
*WASTE SORTING STICKERS*

P. **28**  **PATTUMIERE IN METALLO**  
*METAL PEDAL BINS*

P. **48**  **PORTAROTOLI INDUSTRIALI**  
*INDUSTRIAL ROLL DISPENSERS*

P. **30**  **CONTENITORI IN PLASTICA**  
*PLASTIC WASTE CONTAINERS*

P. **52**  **ACCESSORI PER SPAZI ALIMENTARI**  
*EQUIPMENT FOR FOOD AREAS*

P. **40**  **BIDONI IN PLASTICA**  
*PLASTIC TRASH CANS*

P. **53**  **STERMINATORI D'INSETTI**  
*FLYING INSECT KILLERS*

P. **42**  **PATTUMIERE IN PLASTICA**  
*PLASTIC BINS*

P. **57**  **DISABITUANTI**  
*DETERRENTS*







## MEC

120  
L



1305 mm  
565 mm  
600 mm

### Contenitore con sportello basculante

- Struttura in acciaio inox satinato con basculante per svuotamento vassoio
- Anta inferiore invertibile con chiusura a chiave triangolare
- Guida ferma vassoi in opzione (LxPxH 605x460x115 mm)
- Piedi regolabili (altezza max 5 cm)
- Progettato per ospitare un contenitore da 120 lt (non compreso)
- Ideale per bar, fast-food, self-service e mense
- Prodotto correlato: contenitore mobile da 120 L (pag.240-242)
- Kit quattro ruote Ø 40 mm in opzione (2 ruote con freno)

### Waste container with swinging door

- Brushed stainless steel body with swing door for easy access to the bin
- Front door with triangular key lock
- Top tray holder sold separately (LxPxH 605x460x115 mm)
- Adjustable feet (5 cm max height)
- Holds a 120 L watertight wheeled waste bin (not included)
- Ideal for food service facilities
- Related items: 120 L waste container (page 240-242)
- Four wheels Ø 40 mm as option (2 with breaks)



Basculante / Swing door  
LxH 540x220 mm



Contenitore 120 L in opzione  
120 L container sold separately



Kit ruote in opzione  
Wheels as option

Contenitore inox satinato 120 L Brushed s.steel bin 120 L	789000
Guida fermavassoi inox satinato Brushed s.steel tray stand	789010
Kit quattro ruote Ø 40 mm (2 con freno) Four wheels kit Ø 40 mm (2 w/breaks)	789099

## MINI MEC

50  
L



1160 mm  
324 mm  
400 mm



1075 mm  
324 mm  
400 mm

### Contenitore con sportello basculante

- Struttura in acciaio inox satinato o metallo verniciato
- Sportello frontale basculante
- Guida ferma vassoi in opzione (LxPxH 405x268x115 mm)
- Reggisacco interno in metallo galvanizzato
- Anta inferiore invertibile con chiusura a chiave triangolare
- Piedi regolabili (altezza max. 5 cm)
- Kit quattro ruote Ø 40 mm in opzione (2 ruote con freno)

### Waste container with swinging door

- Brushed stainless steel or coated steel body
- Swinging door for easy access to the bin
- Top tray holder sold separately (LxPxH 405x268x115 mm)
- Inside bag holder from galvanized steel
- Front door with triangular key lock
- Adjustable feet (5 cm max. height)
- Four wheels Ø 40 mm as option (2 with breaks)



Basculante / Swing door  
LxH 340x217 mm



Reggisacco incluso  
Sack holder included



Kit ruote in opzione  
Wheels as option

Contenitore inox satinato 50 L Brushed s.steel waste container 50 L	789005
Contenitore metallo bianco 50 L White steel waste container 50 L	789006
Guida fermavassoi inox satinato Brushed s.steel tray stand	789011
Guida fermavassoi metallo bianco White coated steel tray stand	789012
Kit quattro ruote Ø 40 mm (2 con freno) Four wheels kit Ø 40 mm (2 w/breaks)	789099



## SBARAZZINO

70  
L



725 mm  
520 mm  
550 mm

∅ 95 mm

### Contenitore mobile a pedale ad apertura centrale

- Acciaio inox brillante
- Pedale e maniglia in acciaio verniciato con polvere epossidica
- Frontale asportabile per facilitare il ricambio del sacco
- Ampio pedale per utilizzo conforme al metodo HACCP
- Ruote in gomma per un facile spostamento
- Elastico fermasacco
- Ideale per essere inserito sotto il piano di lavoro (sbarazzo)
- Brevettato

### Mobile waste container with pedal and central opening

- Polished stainless steel body and lid
- Push bar and pedal from powder epoxy coated steel
- Removable front panel for easy bag change
- Elastic strap for holding the bag in place
- Large foot pedal for hands-free operation
- Two smooth wheels for easy maneuvering
- To be placed under worktops or table waste hatches
- Patented product



Apertura  
Opening



Sotto il piano  
Under the workshop



Sotto il piano aperto  
Open under the workshop

Contenitore apertura centrale inox brillante 70 L  
Central opening waste container polished s.steel 70 L

790680

## FRONTINOX

70  
L



755 mm  
450 mm  
480 mm

∅ 95 mm

### Contenitore mobile a pedale con apertura a libro

- Acciaio inox brillante
- Pedale e maniglia in metallo verniciato con polvere epossidica
- Apertura a libro per facilitare il ricambio del sacco
- Ampio pedale per utilizzo conforme al metodo HACCP
- Elastico fermasacco
- Ruote in gomma per un facile spostamento

### Mobile pedal waste container with front opening

- Polished stainless steel
- Push bar and pedal in powder epoxy coated steel
- Front opening for easy bag change
- Large foot pedal for hands-free operation
- Elastic strap for holding the bag in place
- Two smooth wheels for easy maneuvering



Apertura / Opening

Contenitore apertura a libro inox brillante 70 L  
Front opening waste container polished s.steel 70 L

790640



## CONTINOX



Grande Apertura  
Wide opening



Frontale asportabile  
Removable front door

### Contenitore mobile a pedale

- Struttura e coperchio in acciaio inox, con finitura brillante o satinata
- Pedale e maniglia in acciaio verniciato o in inox
- Frontale asportabile per facilitare il ricambio del sacco
- Elastico fermasacco
- Ruote in gomma per un facile spostamento
- Ampio pedale per utilizzo conforme al metodo HACCP

### Mobile pedal waste container

- Stainless steel body and lid, with polished or brushed finish
- Push bar and pedal in coated steel or s.steel
- Removable front panel for easy bag change
- Elastic strap for holding the bag in place
- Two smooth wheels for easy maneuvering
- Large foot pedal for hands-free operation



Contenitore a pedale inox brillante 70 L <i>Pedal container polished s.steel 70 L</i>	<b>790630</b>
Contenitore a pedale inox satinato 70 L <i>Pedal container brushed s.steel 70 L</i>	<b>790650</b>
Contenitore a pedale inox brillante + tubolari inox 70 L <i>Pedal container polished s.steel + s.steel tubes 70 L</i>	<b>790670</b>
Contenitore a pedale inox brillante 110 L <i>Pedal container polished s.steel 110 L</i>	<b>790624</b>
Contenitore a pedale inox satinato 110 L <i>Pedal container brushed s.steel 110 L</i>	<b>790644</b>
Contenitore a pedale inox brillante + tubolari inox 110 L <i>Pedal container polished s.steel + s.steel tubes 110 L</i>	<b>790664</b>

## CONTIMAR



### Contenitore mobile a pedale auto-estinguente

- Struttura e coperchio in acciaio inox brillante
- Pedale e maniglia in acciaio inox
- Elastico fermasacco
- Ruote in gomma per un facile spostamento
- Corpo privo di aperture per evitare la propagazione del fuoco
- **Ideale per forniture navali**
- **Ritenuto idoneo da Rina Services Spa per la raccolta rifiuti a bordo nave**
- **Certificato da CNPP come prodotto auto-estinguente e non propagatore di fuoco**

### Self extinguishing mobile pedal waste container

- Stainless steel body and lid, with polished finish
- Push bar and pedal in s.steel
- Elastic strap for holding the bag in place
- Smooth wheels for easy maneuvering
- Inner structure free from openings to prevent fire from spreading
- **Ideal for naval use**
- **Attested by Rina Services SPA, a naval certification body, for waste collection aboard ship**
- **CNPP certified as fireproof and fire retardant**



Privo di aperture  
Free of openings



Auto-estinguente  
Self extinguishing



Ideale per forniture navali  
Ideal for naval use

Contenitore a pedale inox brillante 70 L <i>Pedal container polished s.steel 70 L</i>	<b>790660</b>
--	---------------







## CONTICOLOR



### Contenitore mobile a pedale

- Struttura e coperchio in metallo verniciato con polvere epossidica
- Disponibile in vari colori per la raccolta differenziata (Vers. 110 L)
- Frontale asportabile per facilitare il ricambio del sacco
- Ampio pedale per utilizzo conforme al metodo HACCP
- Elastico fermasacco
- Ruote in gomma per un facile spostamento

### Mobile pedal waste container

- Powder epoxy coated steel body and lid
- Several color options available to encourage waste separation (Vers. 110 L)
- Removable front panel for easy bag change
- Large foot pedal for hands-free operation
- Elastic strap for holding the bag in place
- Two smooth wheels for easy maneuvering



Varianti colore / Colors available



Grande apertura  
Wide opening



Frontale asportabile  
Removable front door

Contenitore a pedale metallo bianco 70 L Pedal container white steel 70 L	791130
Contenitore a pedale metallo bianco 110 L Pedal container white steel 110 L	791124
Contenitore a pedale metallo blu 110 L Pedal container blue steel 110 L	791225
Contenitore a pedale metallo giallo 110 L Pedal container yellow steel 110 L	791226
Contenitore a pedale metallo rosso 110 L Pedal container red steel 110 L	791227
Contenitore a pedale metallo verde 110 L Pedal container green steel 110 L	791228
Contenitore a pedale metallo nero + tubolari inox 110 L Pedal container black steel + s.steel tubes 110 L	791221



## CONTIFIX

110  
L



965 mm  
440 mm  
480 mm

### Contenitore statico a pedale

- Struttura e coperchio in acciaio inox brillante
- Pedale e maniglia in acciaio verniciato
- Frontale asportabile per facilitare il ricambio del sacco
- Elastico fermasacco
- Supporti in tubolare con quattro punti d'appoggio
- Ampio pedale per utilizzo conforme al metodo HACCP

### Static pedal waste container

- Polished stainless steel body and lid
- Push bar and pedal in coated steel
- Removable front panel for easy bag change
- Elastic strap for holding the bag in place
- Static base to prevent accidental moving
- Large foot pedal for hands-free operation



Grande apertura  
Wide opening



Frontale asportabile  
Removable front door

Contenitore statico a pedale inox brillante 110 L  
Static pedal container polished s.steel 110 L

790724

## CONTIFIX COLOR

110  
L



965 mm  
440 mm  
480 mm

### Contenitore statico a pedale

- Struttura e coperchio in metallo verniciato con polvere epossidica
- Frontale asportabile per facilitare il ricambio del sacco
- Ampio pedale per utilizzo conforme al metodo HACCP
- Elastico fermasacco
- Supporti in tubolare con quattro punti d'appoggio

### Static pedal waste container

- White coated steel body and lid
- Removable front panel for easy bag change
- Large foot pedal for hands-free operation
- Elastic strap for holding the bag in place
- Static base to prevent accidental moving



Grande Apertura  
Wide opening



Frontale asportabile  
Removable front door

Contenitore statico a pedale metallo bianco 110 L  
Static pedal container white steel 110 L

791224





## CONTIMAR FIX

70  
L



760 mm  
440 mm  
480 mm

### Contenitore statico a pedale auto-estinguente

- Struttura e coperchio in acciaio inox brillante
- Pedale in acciaio inox
- Elastico fermasacco
- Supporti in tubolare inox con quattro punti d'appoggio
- Corpo privo di aperture per evitare la propagazione del fuoco
- **Ideale per forniture navali**
- **Ritenuto idoneo da Rina Services Spa per la raccolta rifiuti a bordo nave**
- **Certificato da CNPP come prodotto autoestinguente e non propagatore di fuoco**

### Self extinguishing static pedal waste container

- Stainless steel body and lid, with polished finish
- Push bar and pedal in stainless steel
- Elastic strap for holding the bag in place
- S.steel static base to prevent accidental moving
- Inner structure free from openings to prevent fire from spreading
- **Ideal for naval use**
- **Attested by Rina Services SPA, a naval certification body, for waste collection aboard ship**
- **CNPP certified as fireproof and fire retardant**



Privo di aperture  
Free of openings



Auto-estinguente  
Self extinguishing



Ideale per  
forniture navali  
Ideal for  
naval use



Contenitore statico a pedale inox brillante 70 L  
Static pedal container polished s.steel 70 L

790760

## QUARANTA

40  
L



625 mm  
360 mm

### Contenitore a pedale

- Struttura e coperchio in inox brillante
- Maniglia di trasporto integrata
- Coperchio con chiusura silenziosa
- Secchio interno in plastica
- Pedale in metallo con rivestimento in gomma
- Base in plastica

### Pedal waste container

- Polished stainless steel body and lid
- Built-in back handle for easy moving
- Silent closing lid
- Plastic inner bucket with handle
- Metal pedal with rubber lining
- Non-scratch plastic base



Contenitore a pedale inox brillante 40 L  
Pedal waste container polished s.steel 40 L

101400



## STAGNO

### Contenitore mobile a pedale a tenuta stagna

- Struttura e coperchio in inox AISI 304 con finitura satinata
- Pedale in acciaio inox AISI 304
- Contenitore a tenuta stagna
- Coperchio e contenitore asportabili per una migliore manutenzione
- Maniglie laterali fisse
- Ruote girevoli per un facile spostamento

### Watertight pedal waste container

- AISI 304 stainless steel body and lid, with scotch brite finishing
- AISI 304 stainless steel pedal
- Watertight waste container
- Easy-grip side handles
- Removable lid and container for easy cleaning and maintenance
- Rotating non-marking rubber wheels

90  
L



900 mm  
400 mm

70  
L



700 mm  
400 mm



Conten. tenuta stagna inox 304 satinato 70 L  
Watertight cont. brushed 304 s.steel 70 L

792070

Conten. tenuta stagna inox 304 satinato 90 L  
Watertight cont. brushed 304 s.steel 90 L

792090

## PELICANTE

### Contenitore a pedale

- Struttura e coperchio in inox
- Secchio interno in acciaio galvanizzato con maniglia
- Pedale in metallo con rivestimento in gomma
- Base in gomma

### Pedal waste container

- Stainless steel body and lid
- Galvanized inner bucket with metal handle
- Metal pedal with rubber lining
- Non-scratch rubberized base

80  
L



765 mm  
420 mm

60  
L



610 mm  
420 mm



Pedale  
Pedal



Contenitore a pedale inox brillante 80 L  
Pedal bin polished s.steel 80 L

790280

Contenitore a pedale inox brillante 60 L  
Pedal bin polished s.steel 60 L

790260



## TRIFLUX

3x110  
L



Ruote con freno  
Wheels with brake



Ideale per differenziata  
Ideal for recycling

970 mm  
420 mm  
860 mm



### Carrello portasacco per la raccolta differenziata

- Tubolari in metallo verniciato bianco
- Tre portasacchi da 110 L
- Quattro ruote girevoli anti-traccia (2 con freno)
- Tamponi in gomma anti-urto
- Molto robusto e maneggevole

### Waste sorting triple bag holder

- White powder epoxy coated steel frame
- Three compartments (each bag counts 110 L)
- Four rotating non-marking wheels (two with brakes)
- Lateral rubber dumpers
- Self-assembly required

Carrello portasacco metallo bianco 3 x 110 L  
Triple bag holder white steel 3 x 110 L

108010

## FLUXY

110  
L



Pannello / Board  
dim / size  
.250x20x190 mm

850 mm  
550 mm  
410 mm



Sacco da 110 L  
110 L bag



Apertura / Opening  
400x370 mm



### Portasacco

- Struttura in tubolari d'acciaio bianco
- Ospita un sacco da 110 L
- Quattro piedini in gomma
- Il sacco è sorretto per tensione
- Placca segnaletica neutra in opzione
- Personalizzabile con etichette acquistabili separatamente (pag. 47)

### Bag holder

- White powder epoxy coated steel tubes
- For 110 litres liners
- Non scratch 4-points stand
- Bag held in place by tautness
- Info board available as option
- Customizable with recycling stickers sold separately (p. 47)

Portasacco metallo bianco 110 L  
Bag holder white steel 110 L

789123

Pannello informativo neutro metallo bianco  
Information board white steel

789133

## CONTICLAP

110  
L



Apertura  
Opening



Gancio reggi utensili  
Hook



Due ruote con freno  
Wheels with 2 breaks

960 mm  
430 mm  
600 mm



### Portasacco mobile a chiusura ermetica

- Tubolari in acciaio inox brillante
- Bande in gomma per chiusura ermetica
- Vassoio inferiore per reggere sacchi da 110 L
- Ampio pedale con gomma antiscivolo
- Due ruote con freni
- Robusto e facile da assemblare

### Bag holder with sealing clip

- Tubular polished stainless steel frame
- Rubber bands for holding the bag sealed
- For 110 litres liners
- Large pedal for hands-free operation
- Two wheels with brakes
- Heavy duty and easy to assemble

Portasacco ermetico inox brillante 110 L  
Bag holder with sealing clip polished s.steel 110 L

107500





## CONTIMOBILE



### Portasacco mobile con coperchio a pedale

- Struttura e coperchio in inox brillante (AISI 430 o 304) o metallo verniciato
- Disponibile con coperchi colorati per incentivare la raccolta differenziata
- Elastico fermasacco
- Ampio pedale per utilizzo conforme al metodo HACCP
- Due ruote in plastica anti-traccia Ø 150 mm
- Stabile e maneggevole
- Montaggio semplice e veloce
- Pannello informativo in opzione

### Mobile bag holder with lid

- Available from polished s.steel (AISI 430 or 304) or epoxy coated steel
- Colored lids to encourage waste separation
- Pedal operated frame for 110 L bags
- Easy-grip handle and two non-marking rubber wheels
- Elastic strap for holding the bag in place
- Non-marking plastic wheels Ø 150 mm
- Heavy duty and easy to handle
- Self assembly required
- Information board optional



Varianti colore / Colors available



Grande apertura  
Wide opening



Pannello / Board  
LxPxH 260x10x320 mm



Pannello con adesivo  
Info board with sticker

Portasacco a pedale inox 430 brillante 110 L Pedal bag holder 430 polished s.steel 110 L	<a href="#">601041</a>
Portasacco a pedale inox 304 brillante 110 L Pedal bag holder 304 polished s.steel 110 L	<a href="#">601046</a>
Portasacco a pedale metallo bianco 110 L Pedal bag holder white steel 110 L	<a href="#">601042</a>
Portasacco a pedale metallo grigio 110 L Pedal bag holder grey steel 110 L	<a href="#">601043</a>
Portasacco a pedale metallo bianco-giallo 110 L Pedal bag holder white-yellow steel 110 L	<a href="#">601044</a>
Portasacco a pedale metallo bianco-blu 110 L Pedal bag holder white-blue 110 L	<a href="#">601045</a>
Portasacco a pedale metallo bianco-rosso 110 L Pedal bag holder white-red steel 110 L	<a href="#">601047</a>
Portasacco a pedale metallo bianco-verde 110 L Pedal bag holder white-green steel 110 L	<a href="#">601048</a>
Pannello informativo metallo grigio manganese Information board grey manganese steel	<a href="#">601035</a>



## BIN 304

### Pattumiera a pedale

- Inox AISI 304 brillante
- Maniglia di trasporto integrata in plastica
- Secchio interno in plastica
- Pedale in metallo con rivestimento in plastica
- Base in plastica

### Pedal bin

- AISI 304 polished stainless steel
- Built in plastic handle
- Plastic inner bucket
- Metal pedal with plastic lining
- Non-scratch plastic base



5 L



290 mm  
180 mm

14 L



380 mm  
270 mm

20 L



440 mm  
270 mm



Maniglia | Handle

Pattumiera a pedale inox AISI 304 brillante  
Pedal bin polished AISI 304 s.steel

5 L

14 L

20 L

906705

906712

906720

## BIN PLUS

### Pattumiera a pedale

- Acciaio inox o metallo verniciato bianco
- Maniglia di trasporto posteriore
- Coperchio con chiusura silenziosa
- Sistema di bloccaggio del coperchio per ricambio sacco
- Secchio interno, pedale e base in plastica

### Pedal bin

- Stainless steel or coated steel
- Back handle for easy moving
- Silent closing lid
- Lid may be blocked to facilitate bag replacement
- Plastic inner bucket, pedal and base



3 L



250 mm  
170 mm

5 L



278 mm  
205 mm

12 L



385 mm  
250 mm

20 L



450 mm  
290 mm

30 L



650 mm  
290 mm

Pattumiera a pedale metallo bianco  
Pedal bin white steel

Pattumiera a pedale inox brillante  
Pedal bin polished stainless steel

Pattumiera a pedale inox satinato  
Pedal bin brushed stainless steel

3 L

5 L

12 L

20 L

30 L

112036

112056

112126

112206

112306

112035

112055

112125

112205

112305

112039

112059



## BIN GALVA

### Pattumiera a pedale con secchio in acciaio galvanizzato

- Struttura in acciaio inox brillante
- Secchio interno in acciaio galvanizzato
- Maniglia di trasporto in metallo
- Pedale in metallo con rivestimento in plastica
- Base in plastica anti-graffio

### Pedal bin with galvanized steel inner bucket

- Polished stainless steel body
- Galvanized steel inner bucket
- Metal carry handle on the back
- Metal pedal with plastic lining
- Non-scratch plastic base



5 L



12 L

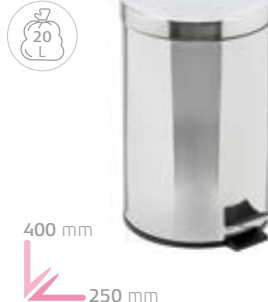

Secchio interno  
Inner bucket

5 L 12 L

Pattumiera inox brillante con secchio galvanizzato  
Polished s.steel bin with galvanized bucket

106405

106412

## NEW BIN BASIC

### Pattumiera a pedale

- Acciaio inox AISI 410 e acciaio zincato verniciato a polvere bianca o nera
- Maniglia di trasporto in plastica
- Secchio interno in polipropilene con impugnatura in plastica
- Pedale in metallo con rivestimento in plastica (vers.inox)
- Pedale in plastica (vers. acciaio zincato bianco e nero)
- Base in plastica

### Pedal bin

- Polished stainless steel and white or black coated steel
- Plastic back handle
- Plastic inner bucket
- Metal pedal with plastic lining (vers. s. steel)
- Plastic pedal (vers. white and black coated steel)
- Non-scratch plastic base



BEST PRICE

3 L



5 L



12 L



Maniglia richiudibile  
Foldable handle



Apertura  
Opening

3 L 5 L 12 L

Pattumiera a pedale inox brillante  
Pedal bin polished s.steel

913030

913050

913120

Pattumiera a pedale acciaio verniciato bianco  
Pedal bin white coated s.steel

913031

913051

913121

Pattumiera a pedale acciaio verniciato nero  
Pedal bin black coated s.steel

913052





## CONTIPLAST

120  
L

130  
L



890 mm  
480 mm  
560 mm

∅ 155 mm



### Contenitore mobile a pedale

- Polipropilene (PP5)
- Sistema d'apertura del coperchio in alluminio verniciato
- Coperchi colorati per incentivare la raccolta differenziata
- Maniglia ergonomica e ruote per un facile spostamento
- Ampio pedale per utilizzo conforme al metodo HACCP
- Robusto e di facile manutenzione
- Venduto in conf. da 1 pz (montato) o 3 pz (da montare)

### Mobile pedal container

- Polypropylène (PP5)
- Aluminum opening mechanism
- Four lid colors to encourage waste separation
- Ergonomic handle and wheels for easy maneuvering
- Large foot pedal for hands-free operation
- Heavy-duty and easy to clean
- Sold in 1 pc/box (assembled) or 3 pcs/box (unassembled)

### Varianti colore / Colors available



Largo pedale  
Large pedal



Ruote ∅ 155 mm  
Wheels ∅ 155 mm



Sistema d'apertura  
Opening mechanism

	1 pz / 1 pc	3 pz / 3 pcs
Contenitore a pedale grigio 120 L Pedal waste container grey 120 L	102530	102030
Contenitore a pedale bianco 120 L Pedal waste container white 120 L	102534	102034
Contenitore a pedale bianco - blu 120 L Pedal waste container white - blue 120 L	102535	102035
Contenitore a pedale bianco - giallo 120 L Pedal waste container white - yellow 120 L	102536	102036
Contenitore a pedale bianco - rosso 120 L Pedal waste container white - red 120 L	102537	102037
Contenitore a pedale bianco - verde 120 L Pedal waste container white - green 120 L	102538	102038



## CONTIBASIC

70  
L



750 mm  
575 mm  
510 mm

∅ 160 mm

### Contenitore mobile a pedale

- Polipropilene (PP5)
- Sistema d'apertura del coperchio in plastica
- Coperchi colorati per incentivare la raccolta differenziata
- Maniglia ergonomica e ruote per un facile spostamento
- Ampio pedale per utilizzo conforme al metodo HACCP
- Venduto in conf. da 1 pz (montato) o 3 pz (da montare)

### Mobile pedal container

- Polypropylene (PP5)
- Plastic opening mechanism
- Four lid colors to encourage waste separation
- Ergonomic handle and two wheels for easy maneuvering
- Large foot pedal for hands-free operation
- Sold in 1 pc/box (assembled) or 3 pcs/box (unassembled)



Varianti colore / Colors available



Ruote ∅ 160 mm  
Wheels ∅ 160 mm



Sistema d'apertura  
Opening mechanism

	1 pz / 1 pc	3 pz / 3 pcs
Contenitore mobile a pedale bianco 70 L Mobile pedal waste container white 70 L	102532	102032
Contenitore mobile a pedale bianco - blu 70 L Mobile pedal waste container white - blue 70 L	102545	102045
Contenitore mobile a pedale bianco - giallo 70 L Mobile pedal waste container white - yellow 70 L	102546	102046
Contenitore mobile a pedale bianco - rosso 70 L Mobile pedal waste container white - red 70 L	102547	102047
Contenitore mobile a pedale bianco - verde 70 L Mobile pedal waste container white - green 70 L	102548	102048



## CONTITOP MOBILE

### Contenitore mobile a pedale

- Polipropilene
- Sistema d'apertura del coperchio in plastica
- Coperchi colorati per incentivare la raccolta differenziata
- Ruote in plastica rigida con banda in gomma
- Largo pedale per facilitarne l'utilizzo senza mani
- Conforme al metodo HACCP
- Venduto in confezione da 1 pz o 3 pz (da montare)

### Mobile pedal container

- Polypropylene
- Plastic opening mechanism
- Four lid colors to encourage waste separation
- Integrated plastic wheels
- Large foot pedal for hands-free operation
- In compliance with the HACCP method
- Sold in 1 pc/box or 3 pcs/box (unassembled)



90  
L



70  
L



Varianti colore | Colors available



Pedale  
Pedal



Ruote Ø 125 mm  
Wheels Ø 125 mm



Sistema d'apertura  
Opening mechanism

	1 pz / 1 pc		3 pz / 3 pcs	
	70 L	90 L	70 L	90 L
Contenitore bianco Waste containr white	115570	115590	115070	115090
Contenitore bianco - blu Waste container white-blue	115575	115595	115075	115095
Contenitore bianco - giallo Waste container white-yellow	115576	115596	115076	115096
Contenitore bianco - rosso Waste container white-red	115577	115597	115077	115097
Contenitore bianco - verde Waste container white-green	115578	115598	115078	115098





## CONTITOP

### Contenitore a pedale

- Polipropilene
- Sistema d'apertura del coperchio in plastica
- Coperchi colorati per incentivare la raccolta differenziata
- Con pedale per utilizzo conforme al metodo HACCP
- Venduto in confezione da 1 pz o 3 pz (da montare)

### Pedal container

- Polypropylene
- Plastic lid opening system
- Four lid colors to encourage waste separation
- Pedal operated, in compliance with the HACCP method
- Sold in 1 pc/box or 3 pcs/box (unassembled)



Varianti colore | Colors available



	1 pz / 1 pc				3 pz / 3 pcs			
	30 L	45 L	70 L	90 L	30 L	45 L	70 L	90 L
Contenitore a pedale bianco <i>Pedal container white</i>	115350	115450	115750	115950	115300	101450	115700	115900
Contenitore a pedale bianco-blu <i>Pedal container white-blue</i>	115355	115455	115755	115955	115305	101455	115705	115905
Contenitore a pedale bianco-giallo <i>Pedal container white-yellow</i>	115356	115456	115756	115956	115306	101456	115706	115906
Contenitore a pedale bianco-rosso <i>Pedal container white-red</i>	115357	115457	115757	115957	115307	101457	115707	115907
Contenitore a pedale bianco-verde <i>Pedal container white-green</i>	115358	115458	115758	115958	115308	101458	115708	115908



## CONTI

80  
L

110  
L



750 mm  
390 mm  
480 mm

### Contenitore mobile a pedale

- Polipropilene
- Sistema d'apertura del coperchio in plastica
- Coperchi e pedale disponibili in vari colori per incentivare la raccolta differenziata
- Conforme al metodo HACCP
- Capacità: 80 L
- Maniglia di trasporto posteriore integrata
- Ruote in plastica per un facile spostamento
- Venduto in confezione da 1 pz o 3 pz

### Mobile pedal container

- Polypropylene
- Plastic lid opening mechanism
- Lids and plastic pedal colors available to encourage waste separation
- Capacity: 80 L
- Integrated plastic wheels
- Large foot pedal for hands-free operation
- in compliance with the HACCP method
- Sold in 1 pc/box or 3 pcs/box



Varianti colore / Colors available



Ruote in plastica Ø 70 mm  
Plastic wheels Ø 70 mm



Pedale in plastica  
Plastic pedal

	80 L	
	1 pz / 1 pc	3 pz / 3 pcs
Contenitore bianco Waste container white	912850	912800
Contenitore bianco - grigio Waste container grey - white	912852	912802
Contenitore bianco - blu Waste container white - blue	912855	912805
Contenitore bianco - giallo Waste container white - yellow	912856	912806
Contenitore bianco - rosso Waste container white - red	912857	912807
Contenitore bianco - verde Waste container white - green	912858	912808
Contenitore bianco - marrone Waste container white - brown	912859	912809



## ECO CONTI

80  
L

110  
L



750 mm  
390 mm  
480 mm

60  
L

110  
L



550 mm  
390 mm  
480 mm



Ruote in plastica Ø 70 mm  
Plastic wheels Ø 70 mm

### Contenitore mobile a pedale in plastica riciclata (min.70%)

- **Plastica riciclata (min. 70 %)**
- Sistema d'apertura del coperchio in plastica
- Coperchi e pedale disponibili in vari colori per incentivare la raccolta differenziata
- Disponibile in versione da 60 L e 80 L
- Conforme al metodo HACCP
- Maniglia di trasporto posteriore integrata
- Ruote in plastica per un facile spostamento
- Venduto in confezione da 1 pz o 3 pz

### Mobile recycled plastic (min. 70%) pedal container

- **Recycled plastic (min.70%)**
- Plastic lid opening mechanism
- Lids and plastic pedal colors available to encourage waste separation
- 60 L and 80 L versions available
- Integrated plastic wheels
- Large foot pedal for hands-free operation
- in compliance with the HACCP method
- Sold in 1 pc/box or 3 pcs/box



**ATTENZIONE:** alcuni prodotti in plastica riciclata possono subire leggere variazioni di tonalità cromatica  
**WARNING:** some recycled plastic products may have slight variations in colour shade

### Varianti colore | Colors available



	80 L		60 L	
	1 pz / 1 pc	3 pz / 3 pcs	1 pz / 1 pc	3 pz / 3 pcs
Contenitore grigio - bianco Waste container grey - white	912870	912820	912670	912620
Contenitore grigio Waste container grey	912872	912822	912672	912622
Contenitore grigio - blu Waste container grey - blue	912875	912825	912675	912625
Contenitore grigio - giallo Waste container grey - yellow	912876	912826	912676	912626
Contenitore grigio - rosso Waste container grey - red	912877	912827	912677	912627
Contenitore grigio - verde Waste container grey - green	912878	912828	912678	912628
Contenitore grigio - marrone Waste container grey - brown	912879	912829	912679	912629





## CLIPPY

NEW

25  
L

30  
L



Chiusura a clip  
Clip closure

450 mm  
400 mm



plastic  
second life

Varianti colore / Colors available



Bidone portarifiuti 25 L  
Trash can 25 L

Grigio-Blu  
Grey-Blue

Grigio-Giallo  
Grey-Yellow

Grigio-Rosso  
Grey-Red

Grigio-Verde  
Grey-Green

720205

720206

720207

720208

## DUCK

NEW

35  
L

50  
L



25  
L

30  
L

520 mm  
370 mm  
370 mm

410 mm  
370 mm  
370 mm



plastic  
second life

### Bidone con sportello "a becco" in "Plastica Seconda Vita"

- Polipropilene (seconda vita) riciclabile al 100%
- Resistente agli agenti atmosferici, chimici ai raggi UV
- Capacità: 35 L e 25 L
- Sportello basculante a becco e coperchio con meccanismo antirandagismo
- Coperchio con cerniere rinforzate per una apertura a 270°
- Comodo maniglione ergonomico con blocco verticale
- Impilabile, inseribile, con presa sul fondo per un facile svuotamento
- Coperchi disponibili in vari colori per incentivare la raccolta differenziata

### "Plastic Second Life" trash can with swing lid

- Polypropylene (second life) 100% recyclable
- Weather, chemical and UV resistant
- Capacity: 35 L and 25 L
- Swinging beak door and lid with anti-random mechanism
- Lid with reinforced hinges for 270° opening
- Ergonomic handle with vertical locking
- Stackable, insertable, with bottom grip for easy emptying
- Lids colors available to encourage waste separation



Sportello basculante  
Swinging Lid



Maniglione ergonomico  
Ergonomic handle



Presa per svuotamento  
Grip for emptying



Impilabile  
Stackable

Varianti colore / Colors available



Bidone sportello basculantei 35 L  
Swinging lid trash can 35 L

Bidone sportello basculante 25 L  
Swinging lid trash can 25 L

Grigio-Blu  
Grey-Blue

Grigio-Giallo  
Grey-Yellow

Grigio-Verde  
Grey-Green

Grigio-Marrone  
Grey-Brown

720115

720116

720118

720119

720105

720106

720108

720109



## BLOOM



80  
L



780 mm  
500 mm  
450 mm

∅ 120 mm



Maniglia  
Handle



4 ganci fermasacco  
4 fixed bag-holding



Impilabile  
Stackable



Ruote e assali  
premontati  
Wheels and axles  
already assembled



Varianti colore / Colors available



Grigio-Blu  
Grey-Blue

Grigio-Giallo  
Grey-Yellow

Grigio-Rosso  
Grey-Red

Grigio-Verde  
Grey-Green

Contenitore 80 L  
Waste container 80 L

720805

720806

720807

720808

## BLOOM PUSH



100  
L



950 mm  
540 mm  
490 mm

∅ 120 mm



Maniglia  
Handle



4 ganci fermasacco  
4 fixed bag-holding



Impilabile  
Stackable



Apertura basculante  
Flap opening



Ruote e assali  
premontati  
Wheels and axles  
already assembled



Varianti colore / Colors available



Grigio-Blu  
Grey-Blue

Grigio-Giallo  
Grey-Yellow

Grigio-Rosso  
Grey-Red

Grigio-Verde  
Grey-Green

Contenitore sportello basculante 100 L  
Swinging lid waste container 100 L

720905

720906

720907

720908



## OFFICE 90

90  
L



755 mm  
510 mm  
285 mm

### Contenitore per la raccolta differenziata

- Secchio e coperchi in polipropilene
- Robusto secchio da 90 L
- Ampia gamma di coperchi colorati per la raccolta differenziata
- Design compatto per un facile collocamento in spazi ridotti
- Facile pulizia e manutenzione

### Recycling waste container

- Bucket and lids made of polypropylene
- Sturdy 90 L grey bucket
- Interchangeable coloured lids for effective waste separation
- Compact design to better fit in small spaces
- Durable and easy to clean



835 mm  
520 mm  
295 mm



835 mm  
520 mm  
295 mm



835 mm  
520 mm  
295 mm



835 mm  
520 mm  
295 mm



835 mm  
520 mm  
295 mm



930 mm  
520 mm  
295 mm

90  
L



∅ 70 mm



Foro per palette  
Hole for stirrers



760 mm  
520 mm  
285 mm

### Contenitore per la raccolta dei bicchieri

- Secchio e coperchio in polipropilene
- Tubi interni in PVC rigido
- Otto aperture attraverso cui inserire i bicchieri
- Ospita fino a 1.600 bicchieri max diametro 70 mm
- Design compatto e semplice da svuotare e pulire

### Cup collector recycling container

- Bucket and lid made of polypropylene
- PVC internal tubes that keep streams separated
- Eight openings allow cups to stack and store
- Holds up to 1.600 cups max diameter 70 mm
- Slim design and easy to empty



Clip per unire i secchi  
Clips to link the buckets

Secchio grigio 90 L Grey bucket 90 L	102200
Gettacarte con coperchio con maniglia 90 L Waste bin with handle lid 90 L	102203
Gettacarte con coperchio slot blu 90 L Waste bin with blue hole lid 90 L	102205
Gettacarte con coperchio foro giallo 90 L Waste bin with yellow hole lid 90 L	102206
Gettacarte con coperchio foro rosso 90 L Waste bin with red hole lid 90 L	102207
Gettacarte con coperchio foro verde 90 L Waste bin with green hole lid 90 L	102208
Gettacarte con coperchio basculante 90 L Waste bin with swing lid 90 L	102210
Gettacarte con coperchio raccolta bicchieri Cup collector recycling bin	102211
Clip per unire i secchi Clips to link the buckets	102220





## OFFICE 60

60  
L



580 mm  
450 mm  
310 mm



150 mm  
470 mm  
325 mm



DISPONIBILE IN AR SU MEDIAL APP  
AVAILABLE IN AR ON MEDIAL APP



660 mm  
450 mm  
320 mm



780 mm  
460 mm  
330 mm



860 mm  
470 mm  
975 mm



Ganci per carrello  
Hooks for trolley

### Contenitore per la raccolta differenziata

- Secchio e coperchi in polipropilene
- Secchio da 60 L con maniglie integrate
- Sette diversi tipi di coperchio a seconda del rifiuto da gestire
- Design compatto per un facile collocamento in ambienti con ridotte dimensioni
- Carrello con ruote per agganciare più contenitori (in opzione)
- Di facile pulizia e manutenzione
- Soluzione ideale per uffici e per il settore della ristorazione collettiva

### Recycling waste container

- Body and lid in Polypropylene
- Grey bucket with built-in handles (60 lt capacity)
- Seven different lids for effective waste separation
- Compact design to better fit in small spaces
- Wheeled trolley to combine multiple bins in one perfect storage solution
- Easy to clean and handle
- Ideal solution for offices or food service industry

Secchio grigio 60 L Grey bucket 60 L	114200
Carrello per gettaccarte Waste bin trolley	114201
Ganci blocca carrello Trolley linking hooks	114202
Gettaccarte con coperchio foro superiore blu 60 L Waste bin with blue upper opening lid 60 L	114205
Gettaccarte con coperchio foro superiore giallo 60 L Waste bin with yellow upper opening lid 60 L	114206
Gettaccarte con coperchio foro superiore rosso 60 L Waste bin with red upper opening lid 60 L	114207
Gettaccarte con coperchio foro superiore verde 60 L Waste bin with green upper opening lid 60 L	114208
Gettaccarte con coperchio grigio apertura push 60 L Waste bin with grey push opening lid 60 L	114210
Gettaccarte con coperchio apertura frontale blu 60 L Waste bin with blue front opening lid 60 L	114215
Gettaccarte con coperchio apertura frontale giallo 60 L Waste bin with yellow front opening lid 60 L	114216



## MAXIPUSH

### Bidoni push

- Polipropilene
- Apertura dello sportello a spinta
- Maniglie laterali integrate
- Portacenere in inox sulla versione 120 L
- Molto robusto e di facile manutenzione

### Push trash cans

- Polypropylene
- Push door access to bin
- Built-in side handles for easy handling
- Ashtray on top only available in the 120 L version
- Heavy duty and easy to maintain

120  
L



970 mm



630 mm

80  
L



780 mm



555 mm



Posacenere / Ashtray

Bidone push con posacenere grigio 120 L  
Push waste container with lid grey 120 L

114120

Bidone push grigio 80 L  
Push waste container grey 80 L

114125

## GABIPUSH

### Bidoni push

- Polipropilene
- Apertura sportello a spinta
- Maniglie integrate per un facile spostamento
- Robusto e di facile manutenzione

### Push trash cans

- Body and lid in polypropylene
- Push opening
- Easy-grip side handles for easy handling
- Heavy duty and easy to clean

110  
L



890 mm



550 mm

80  
L



760 mm



480 mm



Apertura / Opening

Bidone push grigio manganese 110 L  
Push trash can manganese grey 110 L

102010

Bidone push grigio manganese 80 L  
Push trash can manganese grey 80 L

102011



## CUB

### Bidoni

- Polipropilene
- Maniglie laterali integrate
- Molto robusto e di facile manutenzione

### Trash cans

- Polypropylene
- Easy-grip side handles for easy handling
- Heavy duty and easy to maintain



685 mm  
505 mm



615 mm  
505 mm



610 mm  
505 mm



Carrello / Trolley

Bidone grigio 80 L con coperchio piatto Trash can with flat lid grey 80 L	114100
Bidone grigio 80 L Trash can grey 80 L	114105
Bidone grigio 80 L con coperchio a imbuto Trash can with funnel shaped lid grey 80 L	114110
Carrello Trolley	114115

## BIRILLO

### Bidone

- Secchio in polipropilene
- Venduto in confezione da 4 pezzi
- Capiente e di facile manutenzione

### Trash can

- Polypropylene
- Sold 4 pcs per box
- Big capacity and easy to maintain



∅ 400 mm



490 mm  
310 mm

Bidone nero 45 L Trash can black 45 L	102015
--	--------





## RUF

### Pattumiera a pedale

- Polipropilene
- Sistema di apertura del coperchio in plastica (3, 6, 12 L) e metallo (20, 40 L)
- Secchio interno in plastica con maniglia
- Stabili e di facile manutenzione

### Pedal bin

- Polypropylene
- Plastic opening mechanism (3, 6, 12 L); metal (20, 40 L)
- Plastic inner bucket with handle
- Easy to clean and handle



	3 L	6 L	12 L	20 L	40 L
Pattumiera a pedale (imballo unitario) Pedal bin (sold per unit)	<a href="#">906103</a>	<a href="#">906106</a>	<a href="#">906112</a>	<a href="#">906120</a>	<a href="#">906140</a>
Pattumiera a pedale (imballo multiplo) Pedal bin (sold in packs of multiple items)	<a href="#">906503</a>	<a href="#">906506</a>			

## ESA

### Pattumiera a pedale

- Polipropilene
- Sistema di apertura del coperchio in plastica
- Secchio interno in plastica con maniglia
- Stabili e di facile manutenzione

### Pedal bin

- Polypropylene
- Plastic opening mechanism
- Plastic inner bucket with handle
- Easy to clean and handle

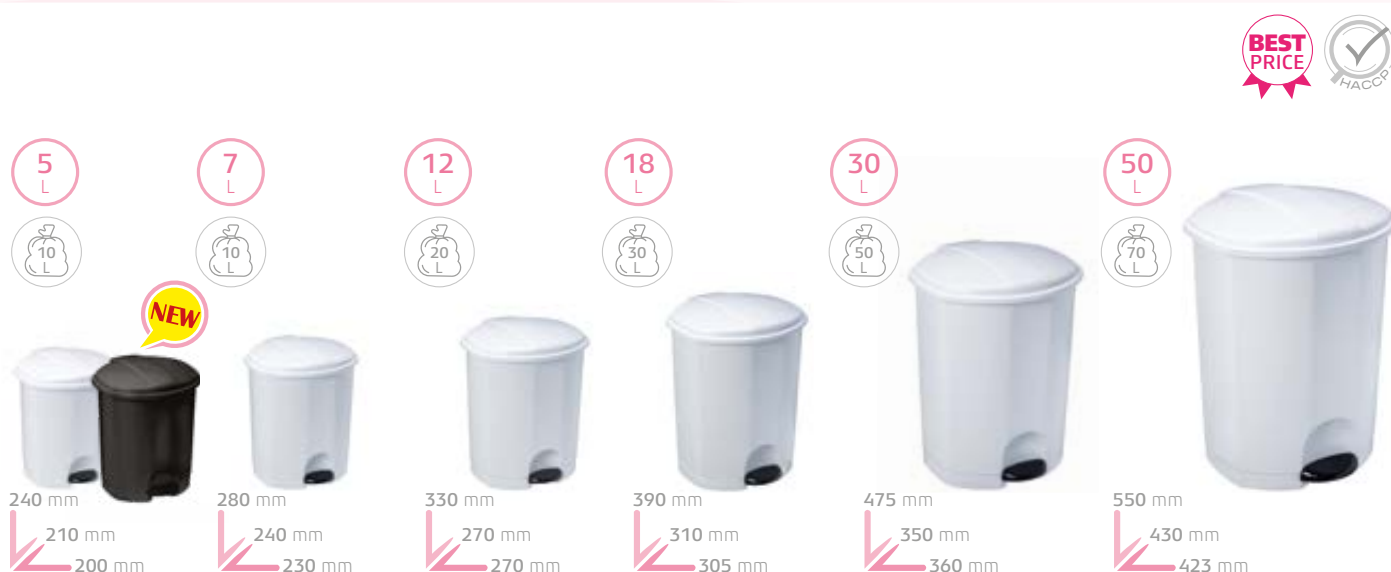

	5 L	7 L	12 L	18 L	30 L	50 L
Pattumiera bianca a pedale (imballo multiplo) White pedal bin (sold in packs of multiple items)	<a href="#">909105</a>	<a href="#">909107</a>	<a href="#">909112</a>	<a href="#">909120</a>	<a href="#">909130</a>	<a href="#">909150</a>
Pattumiera nera a pedale (imballo multiplo) Black pedal bin (sold in packs of multiple items)	<a href="#">909106</a>					



## SLIM

### Pattumiera a pedale

- Polipropilene
- Sistema di apertura del coperchio in metallo
- Reggisacco interno in plastica
- Versione 60 L disponibile in vari colori per raccolta differenziata
- Vendita in conf. singola (montata) o multipla (da montare)

### Pedal bin

- Polypropylene
- Metal opening mechanism
- Plastic inner sack holder
- 60 L version available in several colors for waste sorting
- Sold singly (assembled) or per pack (unassembled)



10  
L



340 mm  
270 mm  
200 mm

25  
L



465 mm  
362 mm  
270 mm

60  
L



630 mm  
490 mm  
365 mm

Varianti colore / Colors available

60  
L



630 mm  
490 mm  
365 mm

60  
L



630 mm  
490 mm  
365 mm

60  
L



630 mm  
490 mm  
365 mm

60  
L



630 mm  
490 mm  
365 mm

	Imballo unitario - Sold per unit			Imballo multiplo - Sold per box		
	10 L	25 L	60 L	10 L	25 L	60 L
Pattumiera a pedale nera Black pedal bin	909811			909810		
Pattumiera a pedale grigia Grey pedal bin	909911	909926	909961	909910	909925	909960
Pattumiera a pedale grigio-blu Grey-blue pedal bin			909975			909965
Pattumiera a pedale grigio-giallo Grey-yellow pedal bin			909976			909966
Pattumiera a pedale grigio-rosso Grey-red pedal bin			909977			909967
Pattumiera a pedale grigio-verde Grey-green pedal bin			909978			909968



## RIF BASIC

### Pattumiera con coperchio basculante

- Polipropilene ad alta densità
- Coperchio basculante, utile come fermasacco
- Versione 50 L disponibile in vari colori per raccolta differenziata
- Stabile e di facile manutenzione
- Supporto murale in metallo in opzione

### Swing waste bin

- High-density polypropylene plastic
- Swing access to bin-lid can be used as sack holder
- 50 L version available in several colors for waste sorting
- Easy to clean and handle
- Wall mounting kit sold separately



Varianti colore / Colors available

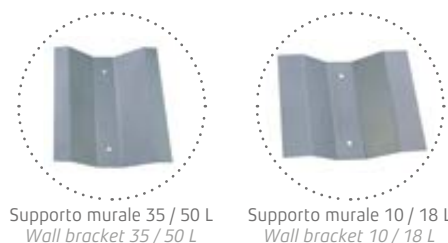

Supporto murale 35 / 50 L  
Wall bracket 35 / 50 L

Supporto murale 10 / 18 L  
Wall bracket 10 / 18 L

	10 L	18 L	35 L	50 L
Pattumiera con basculante bianco Waste bin with white swing lid	909010	909018	909035	909050
Pattumiera con basculante blu Waste bin with blue swing lid				909055
Pattumiera con basculante giallo Waste bin with yellow swing lid				909056
Pattumiera con basculante rosso Waste bin with red swing lid				909057
Pattumiera con basculante verde Waste bin with green swing lid				909058
Pattumiera nera con basculante nera Black waste bin with black swing lid			909535	
Supporto murale Wall bracket	779905	779905	779906	779906



## ECO RIF

### Pattumiera con coperchio basculante

- Corpo e coperchio in **polipropilene 100% riciclato**
- Coperchio basculante grigio-nero
- Disponibile nella versione da 50 L
- Stabile e robusto
- Venduto in confezione da 5 pz

### Swing lid waste bin

- Body and lid **100% recycled polypropylene**
- Black-grey lid with swinging flap
- Available in 50 L version
- Stable and robust
- Sold in 5 pc/box



#### Coperchio Basculante Lid With Swinging Flap



50 L



680 mm  
345 mm  
440 mm



**ATTENZIONE:** alcuni prodotti in plastica riciclata possono subire leggere variazioni di tonalità cromatica  
**WARNING:** some recycled plastic products may have slight variations in colour shade

Pattumiera con basculante grigio/nero 50 L  
Grey/black swing lid waste bin 50 L

907451

## SISTEMI PER LA PULIZIA | CLEANING SYSTEMS



## RAINBOW

Manico lungo  
Long handle



760 mm  
250 mm  
350 mm

Varianti colore / Colors available



### Paletta alza immondizia con manico

- Metallo zincato o metallo verniciato
- Disponibile con manico lungo
- Versione zincata venduta in conf. da 12 pz
- Versione monocolore venduta in conf. da 12 pz
- Versione colori assortiti in conf. da 12 pz (3 pz per colore)

### Dustpan with handle

- Galvanized steel or epoxy coated steel
- Available with long handle
- Galvanized dustpan (12 pcs per box)
- Unicolor dustpan (12 pcs per box)
- Mixed colour version (12 pcs per box - 3 pcs per color)



Paletta zincata con manico lungo Zincked steel dustpans w/long handle	718270
Paletta confezione mista con manico lungo Mixed coloured dustpans w/long handle	718275
Paletta blu con manico lungo Blue dustpans w/long handle	718375
Paletta giallo con manico lungo Yellow dustpans w/long handle	718376
Paletta rosso con manico lungo Red dustpans w/long handle	718377
Paletta verde con manico lungo Green dustpans w/long handle	718378





## STIK

### Etichette autoadesive

- Etichette adesive pre-fustellate in PVC con finitura lucida
- Applicabili su tutti i tipi di superfici, sia in plastica che metallo
- Utili per organizzare in modo efficace la raccolta differenziata
- Idonee per uso interno ed esterno
- Altri colori e soggetti personalizzabili su richiesta

### Recycling stickers

- Pre-cut adhesive labels made from gloss PVC
- Can be applied on all types of surfaces, both plastic and metal
- Useful to encourage waste sorting
- Suitable for indoor and outdoor use
- Extra texts, icons and colours can be customised on request

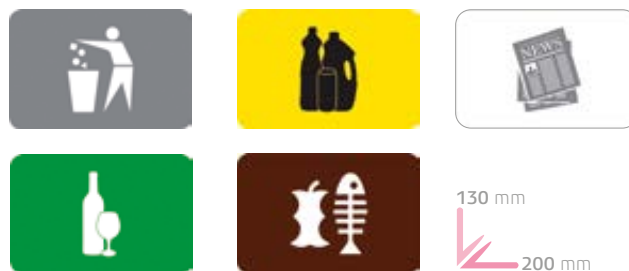
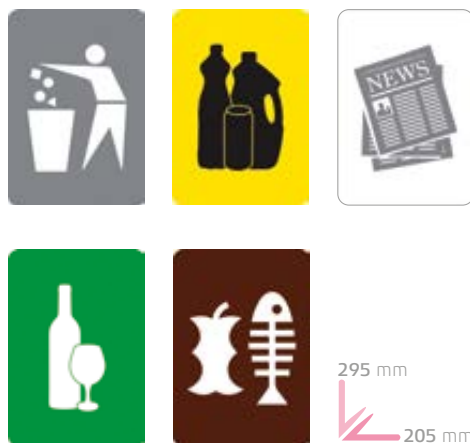

	Generico General Waste	Plastica Plastic	Carta Paper	Vetro Glass	Umido Food waste
Etichetta autoadesiva orizzontale 200x130 mm Recycling stickers horizontal 200x230 mm	701070	701071	701072	701073	701074
Etichetta autoadesiva verticale 205x130 mm Recycling stickers vertical 205x295 mm	701050	701051	701052	701053	701054

## STIK

### Etichette autoadesive

- Etichette adesive pre-fustellate in vinile bianco o nero opaco
- Applicabili su tutti i tipi di superfici, sia plastica che metallo
- Utili per organizzare in modo efficace la raccolta differenziata
- Idonee per uso interno ed esterno
- Altri testi, soggetti e colori personalizzabili su richiesta

### Recycling stickers

- Pre-cut adhesive labels made from matt white or black vinyl
- Can be applied on all types of surfaces, both plastic and metal
- Useful to encourage waste sorting
- Suitable for indoor and outdoor use
- Extra texts, icons and colours can be customised on request



SCANSIONA IL QR CODE E GUARDA  
IL VIDEO TUTORIAL

SCAN THIS QR CODE TO SEE THE  
VIDEO TUTORIAL





# STIK

ITA Vinile Nero o Bianco / White or black vinyl

GENERICO  
PLASTICA  
CARTA  
VETRO  
ORGANICO  
RICICLABILE   
NON RICICLABILE

ENG Vinile Nero o Bianco / White or black vinyl

GENERAL WASTE  
PLASTIC  
PAPER  
GLASS  
FOOD WASTE  
RECYCLABLE   
NON-RECYCLABLE

Icone / Icons



FRA Vinile Nero o Bianco / White or black vinyl

AUTRES DECHETS  
PLASTIQUE  
PAPIER  
VERRE  
COMPOSTABLE  
RECYCLABLE   
NON RECYCLABLE

DEU Vinile Nero o Bianco / White or black vinyl

RESTMULL  
PLASTIK  
PAPIER  
GLAS  
BIOMÜLL  
RECYCELBAR   
NICHT RECYCELBAR

Altezza lettera: 45 mm.  
La lunghezza cambia a seconda della parola.

Misure riquadro icone  
Icons frame sizes

Letter height: 45 mm.  
The length changes according to the word.

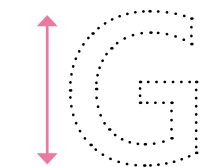

45 mm

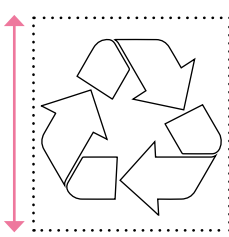

130 mm

120 mm



	ICON	ITA	ENG	FRA	DE
Generico (Nera) General waste (Black)	<a href="#">711210</a>	<a href="#">711300</a>	<a href="#">711310</a>	<a href="#">711320</a>	<a href="#">711330</a>
Plastica (Nera) Plastic (Black)	<a href="#">711211</a>	<a href="#">711301</a>	<a href="#">711311</a>	<a href="#">711321</a>	<a href="#">711331</a>
Carta (Nera) Paper (Black)	<a href="#">711212</a>	<a href="#">711302</a>	<a href="#">711312</a>	<a href="#">711322</a>	<a href="#">711332</a>
Vetro (Nera) Glass (Black)	<a href="#">711213</a>	<a href="#">711303</a>	<a href="#">711313</a>	<a href="#">711323</a>	<a href="#">711333</a>
Organico (Nera) Food waste (Black)	<a href="#">711214</a>	<a href="#">711304</a>	<a href="#">711314</a>	<a href="#">711324</a>	<a href="#">711334</a>
Riciclabile (Nera) Recyclable (Black)	<a href="#">711216</a>	<a href="#">711306</a>	<a href="#">711316</a>	<a href="#">711326</a>	<a href="#">711336</a>
Non riciclabile (Nera) Non-recyclable (Black)	<a href="#">711217</a>	<a href="#">711307</a>	<a href="#">711317</a>	<a href="#">711327</a>	<a href="#">711337</a>
	ICON	ITA	ENG	FRA	DE
Generico (Bianca) General waste (White)	<a href="#">711200</a>	<a href="#">711100</a>	<a href="#">711110</a>	<a href="#">711120</a>	<a href="#">711130</a>
Plastica (Bianca) Plastic (White)	<a href="#">711201</a>	<a href="#">711101</a>	<a href="#">711111</a>	<a href="#">711121</a>	<a href="#">711131</a>
Carta (Bianca) Paper (White)	<a href="#">711202</a>	<a href="#">711102</a>	<a href="#">711112</a>	<a href="#">711122</a>	<a href="#">711132</a>
Vetro (Bianca) Glass (White)	<a href="#">711203</a>	<a href="#">711103</a>	<a href="#">711113</a>	<a href="#">711123</a>	<a href="#">711133</a>
Organico (Bianca) Food waste (White)	<a href="#">711204</a>	<a href="#">711104</a>	<a href="#">711114</a>	<a href="#">711124</a>	<a href="#">711134</a>
Riciclabile (Bianca) Recyclable (White)	<a href="#">711206</a>	<a href="#">711106</a>	<a href="#">711116</a>	<a href="#">711126</a>	<a href="#">711136</a>
Non riciclabile (Bianca) Non-recyclable (White)	<a href="#">711207</a>	<a href="#">711107</a>	<a href="#">711117</a>	<a href="#">711127</a>	<a href="#">711137</a>



## ROLIND

Reggisacco in opzione  
Sack holder as option



Lama dentellata (L 390 mm)  
Serrated bar (L 390 mm)

Versione d'appoggio  
On stand version

810 mm  
450 mm  
480 mm



Versione murale  
o d'appoggio  
Wall-mounted -  
on stand version

Lama dentellata (L 350 mm)  
Serrated bar (L 350 mm)

345 mm  
275 mm  
392 mm

### Portarotolo industriale

- Acciaio inox AISI 304 brillante o metallo verniciato bianco
- Compatibile con rotoli di Ø esterno max. 350 mm
- Compatibile con rotoli aventi anima interna Ø min. 20 mm
- Lama dentellata per un taglio facile della carta
- Due coni blocca-rotolo (Ø min. 42 mm, Ø max. 55 mm) con gommini
- Reggisacco in metallo acquistabile separatamente

### Industrial towel roll holder

- AISI 304 polished s.steel or powder epoxy coated steel
- Holds one roll having external Ø 350 mm
- Compatible with roll having an inner carton tube Ø 20 mm min.
- Roll holder bar 430 mm
- Paper can be cut easily with the adjustable serrated bar
- Plastic cones hold the roll securely in place (Ø min. 42 mm, Ø max. 55 mm)
- Sack holder as option, sold separately



Portarotolo metallo bianco murale / d'appoggio Roll holder white steel (wall-mounted / on stand)	700014
Portarotolo inox 304 murale / d'appoggio Roll holder 304 s.steel (wall-mounted/on stand)	753233
Portarotolo metallo bianco d'appoggio Roll holder white steel (on stand)	700030
Portarotolo inox 304 d'appoggio Roll holder 304 s.steel (on stand)	707005
Reggisacco metallo bianco White metal sack holder	700050

## ROLIND BASIC



295 mm  
265 mm  
380 mm

### Portarotolo industriale murale

- Acciaio inox AISI 304 brillante o metallo verniciato bianco
- Compatibile con rotoli di Ø esterno max. 260 mm
- Compatibile con rotoli aventi anima interna Ø min. 20 mm
- Tubo reggi-rotolo lungo 380 mm
- Lama dentellata (L 350 mm) per un taglio facile della carta
- Coni bloccarotolo (Ø min. 42 mm, Ø max. 55 mm) con gommini
- Fissaggio murale

### Wall-mounted industrial towel roll holder

- AISI 304 s.steel or powder epoxy coated steel
- Holds one roll having external Ø 260 mm
- Compatible with roll having an inner carton tube Ø 20 mm min.
- Roll holder bar 380 mm
- Paper can be cut easily with the adjustable serrated bar (350 mm)
- Plastic cones hold the roll securely in place (Ø min. 42 mm, Ø max. 55 mm)
- Wall mounted fixing kit not included



Portarotolo murale metallo bianco Wall-mounted dispenser white steel	700015
Portarotolo murale inox 304 brillante Wall-mounted dispenser 304 polished steel	700010



## ROLIND EVO

Versione d'appoggio  
On stand version



790 mm  
350 mm  
400 mm



### Portarotolo industriale d'appoggio

- Acciaio inox AISI 304
- Diametro max. rotolo: **Ø 500 mm**
- Larghezza max. rotolo: **380 mm**
- Compatibile con rotoli aventi anima interna **Ø 70 mm**
- Lama dentellata in plastica per un taglio facile della carta
- Venduto in confezioni da 6 pezzi
- Viteria inclusa

### On stand industrial towel roll holder

- AISI 304 s.steel
- Max. roll diameter: **Ø 500 mm**
- Max. roll width: **380 mm**
- Compatible with roll having an inner carton tube **Ø 70 mm**
- Paper can be cut easily with the adjustable plastic serrated bar
- Sold 6 pcs per pack
- Screw and plugs included

Portarotolo industriale d'appoggio  
On stand industrial towel roll holder

920901

## ROLIND EVO



Versione murale  
Wall-mounted version

450 mm  
190 mm  
400 mm



### Portarotolo industriale murale o d'appoggio

- Acciaio inox AISI 304
- Assale, mandrino e supporto in ABS
- Diametro max. rotolo: **Ø 500 mm**
- Larghezza max. rotolo: **380 mm**
- Compatibile con rotoli aventi anima interna **Ø 70 mm**
- Lama dentellata in plastica per un taglio facile della carta
- Venduto in confezioni da 6 pezzi
- Viteria inclusa

### Wall-mounted or on stand industrial towel roll holder

- AISI 304 s.steel
- ABS axle, spindle and support
- Max. roll diameter: **Ø 500 mm**
- Max. roll width: **380 mm**
- Compatible with roll having an inner carton tube **Ø 70 mm**
- Paper can be cut easily with the adjustable plastic serrated bar
- Sold 6 pcs per pack
- Screw and plugs included

Versione d'appoggio  
Stand version



530 mm  
190 mm  
400 mm



Portarotolo industriale murale o d'appoggio  
Wall-mounted or on stand industrial towel roll holder

920900





## ROLLOUT



350 mm  
345 mm  
410 mm

### Distributore di carta in bobina

- Base in ABS bianco e carenatura in ABS trasparente
- Dim. max rotolo: (Ø) 290 mm x (L) 290 mm
- Murale o d'appoggio
- Viteria inclusa

### Center pull towel paper dispenser

- White ABS base and blue transparent ABS casing
- Max. roll dimensions: (Ø) 290 mm x (L) 290 mm
- Wall-mounted or on-table stand
- Fixing hardware included



Distributore di carta blu trasparente  
Center pull towel dispenser blue transparent - white

705636

## MAROLL VERTICALE



340 mm  
260 mm  
260 mm

### Maxi distributore carta a srotolamento centrale

- Base in ABS bianco e calotta in ABS trasparente
- Per rotolo asciugamano a sfilamento centrale
- Dim. max rotolo: (Ø) 245 mm x (L) 265 mm
- Chiusura con chiave in plastica
- Viteria inclusa

### Maxi center pull towel paper dispenser

- White ABS base and transparent ABS fairing
- Suitable for center feed roll paper
- Max. roll dimensions: (Ø) 245 mm x (L) 265 mm
- Plastic keyed lock
- Fixing hardware included



Maxi distrib. srotolamento centrale bianco-blu trasparen.  
Maxi center towel dispenser white-blue transparent

700519

## BASICA



356 mm  
214 mm  
240 mm

Varianti colore  
Colors available



### Distributore di carta a srotolamento centrale

- Base in ABS grigio e cover in ABS blu trasparente o bianco
- Per rotolo pretagliato a sfilamento centrale
- Dim. max. rotolo: Ø 200 mm - larghezza 200 mm
- Chiusura con chiave in plastica e viteria inclusa

### Center pull towel dispenser

- Grey ABS backing and blue transparent or white ABS cover
- Holds pre-cut center pull paper roll
- Max. roll dim.: Ø 200 mm - width 200 mm
- Plastic keyed cover and fixing hardware included



Distributore di carta blu trasparente  
Blue transparent center pull dispenser

104024

Distributore di carta bianco  
White center pull dispenser

104025



## WAVE



310 mm  
210 mm  
220 mm

### Distributore di carta a srotolamento centrale

- Base in ABS grigio e cover in ABS bianco
- Base in ABS grigio e cover in SAN blu trasparente
- Per rotolo di carta a sfilamento centrale
- Dim. max rotolo: Ø 190 mm x larghezza 210 mm
- Chiusura con chiave in plastica e viteria inclusa

### Center pull towel paper dispenser

- Grey ABS backing and white ABS cover
- Grey ABS backing and transparent blue SAN cover
- Holds pre-cut center pull paper roll
- Max. roll dimension: Ø 190 mm x width 210 mm
- Plastic keyed cover and fixing hardware included



Varianti colore / Colors available



Distributore di carta blu trasparente  
Blue transparent center pull dispenser

908124

Distributore di carta bianco  
White center pull dispenser

908024

## BRINOX SPIRAL



370 mm  
260 mm  
270 mm

### Distributore carta a srotolamento centrale

- Acciaio inox AISI 304 brillante o AISI 201 satinato
- Per rotolo a sfilamento centrale non pre-tagliato
- Dimensione max. rotolo (ØxH): 250x280 mm
- Adattatore per carta pre-tagliata in opzione (cod. 110594)
- Finestra per il controllo del livello della carta
- Serratura antivandalo in metallo
- Viteria inox inclusa

### Center pull towel paper dispenser

- Polished AISI 304 or brushed AISI 201 stainless steel
- Holds one non-perforated center-pull roll towel
- Max. roll dimension (ØxH): 250x280 mm
- Adapter for perforated paper roll on request (cod. 110594)
- Front viewing window to monitor paper level
- Vandal-proof stainless steel keyed lock
- Stainless steel fixing hardware included



Varianti colore / Colors available



Distributore srotolamento centrale inox 304 brillante  
Center pull towel dispenser 304 polished s.steel

110524

Distributore srotolamento centrale inox 201 satinato  
Center pull towel dispenser 201 brushed s.steel

110525

Adattatore per carta pretagliata  
Adapter for perforated paper

110594



## STERY KS

### Sterilizzatori di coltelli a raggi UVC

- Struttura in acciaio inox AISI 304
- Alimentazione: 220 V - 50 Hz
- Sportelli in plexiglass fumé con chiusura magnetica
- Lampada UVC (253 nm) da 15 W (da sostituire ogni anno)
- Supporto interno a rastrelliera (12 o 20 coltelli)
- Timer automatico pre-programmato (2h)
- Attivazione della sterilizzazione alla chiusura della porta
- Spia verde in funzione; rossa alla fine del ciclo di sterilizzazione
- Azione germicida al 99,99% dopo un ciclo minimo di 110 minuti
- Prodotto testato in laboratorio da Microsept
- Classe di protezione IPX4
- Conforme al metodo HACCP e a norma CE

### UVC-ray knife sterilizer cabinets

- AISI 304 stainless steel casing
- Power supply: 220 V - 50 Hz
- Smoked plexiglass doors with magnetic lock
- 15 W UVC (253 nm) lamp (to be replaced once a year)
- Slotted holder for 12 or 20 knives
- Automatic pre-programmed timer (2h)
- Activation of sterilisation when the door is closed
- Green light in operation; red at the end of the sterilization cycle
- 99.99% germicide action after a minimum cycle of 110 minutes
- Product tested in laboratory by Microsept
- Protection class IPX4
- In compliance with HACCP method and CE requirements

- Rastrelliera  
Slotted holder
- 12 coltelli  
12 knives

607 mm  
145 mm  
346 mm



- Rastrelliera  
Slotted holder
- 20 coltelli  
20 knives

607 mm  
145 mm  
496 mm



Sterilizzatore UVC a rastrelliera per 12 coltelli  
UVC-rays sterilizer w/slotted holder 12 knives

903024

Sterilizzatore UVC a rastrelliera per 20 coltelli  
UVC-ray sterilizer w/slotted holder 20 knives

903025

Lampada UVC  
UVC lamp

903054

## STERY

### Sterilizzatori di coltelli a raggi UVC

- Struttura in acciaio inox AISI 441 satinato
- Alimentazione: 220 V - 50 Hz
- Sportelli in plexiglass fumé con chiusura magnetica
- Lampada UVC (253 nm) da 15 W (da sostituire ogni anno)
- Supporto coltelli a rastrelliera o banda magnetica
- Timer regolabile da 0 a 120 minuti
- Capienza 10 o 20 coltelli
- Abbattimento dei germi (99,99%) con un ciclo minimo di 90 minuti
- Prodotto testato in laboratorio da Microsept
- Classe di protezione IP20
- Conforme al metodo HACCP e a norma CE

### UVC-ray knife sterilizer cabinets

- Brushed AISI 441 stainless steel casing
- Power supply: 220 V - 50 Hz
- Smoked plexiglass doors with magnetic lock
- 15 W UVC (253 nm) lamp (to be replaced once a year)
- Slotted holder or magnetic bar
- Adjustable timer from 0 to 120 minutes
- Two sizes available (10 or 20 knives)
- 99.99% germicide action after a minimum cycle of 90 minutes
- Product tested in laboratory by Microsept
- Protection class IP20
- In compliance with HACCP method and CE requirements

- Rastrelliera  
Slotted holder
- 10 coltelli  
10 knives

595 mm  
145 mm  
370 mm



- Banda magnetica  
Magnetic
- 10 coltelli  
10 knives

593 mm  
145 mm  
525 mm



- Rastrelliera  
Slotted holder
- 20 coltelli  
20 knives

593 mm  
145 mm  
525 mm



- Banda magnetica  
Magnetic holder
- 20 coltelli  
20 knives

593 mm  
145 mm  
939 mm



Sterilizzatore 10 coltelli rastrelliera  
Sterilizer with slotted holder for 10 knives

903021

Sterilizzatore 20 coltelli rastrelliera  
Sterilizer with slotted holder for 20 knives

903022

Sterilizzatore 10 coltelli a magnete  
Sterilizer with magnetic holder for 10 knives

903032

Sterilizzatore 20 coltelli a magnete  
Sterilizer with magnetic holder for 20 knives

903033

Lampada UVC  
UVC lamp

903054



## APPLIQUE

### Sterminatori d'insetti d'arredo con carta moschicida

- Corpo in metallo verniciato bianco
- Alimentazione elettrica da 220 V - 50 Hz
- Lampade fluorescenti 20 W cad. (E 14)
- Raggio d'azione fino a 50 m<sup>2</sup> o 80 m<sup>2</sup>
- Metodo di cattura con carta moschicida
- Fissare al muro ad un'altezza tra 1,80/2,20 mt
- Ideale come accessorio d'arredo
- Conforme al metodo HACCP e a norma CE
- Classe di protezione: IP20

### Decorative flying insect killer with glue board

- White coated steel casing
- Power supply: 220 V - 50 Hz
- Fluo lamps 20 W each (E 14)
- Coverage area up to 50 m<sup>2</sup> or 80 m<sup>2</sup>
- Equipped with glue board
- To be installed at 1,80 - 2,20 mt from the floor
- Ideal as decorative accessory
- In compliance with HACCP method and CE requirements
- Protection class: IP20

- 💡 1x20 W (E14)
- m<sup>2</sup> 50 m<sup>2</sup>
- W 20 W max
- 👤 1,2 Kg
- 🔌 220 V / 50 Hz



172 mm  
205 mm  
460 mm



- 💡 2x20 W (E14)
- m<sup>2</sup> 80 m<sup>2</sup>
- W 40 W max
- 👤 2 Kg
- 🔌 220 V / 50 Hz



172 mm  
205 mm  
705 mm

Sterminatore insetti arredo 20 W fluo <i>Decorative flying insect killer 20 W fluo</i>	<b>903007</b>
Ricambio carta moschicida 180x465 mm <i>Spare glue board 180x465 mm</i>	<b>903047</b>
Sterminatore insetti arredo 40 W fluo <i>Decorative flying insect killer 40 W fluo</i>	<b>903008</b>
Ricambio carta moschicida 205x785 mm <i>Spare glue board 205x785 mm</i>	<b>903045</b>
Lampada fluo 20 W (E 14) <i>Fluo lamp 20 W (E 14)</i>	<b>903057</b>

## IGLU

### Sterminatori d'insetti d'arredo con carta moschicida

- Corpo in inox satinato o metallo verniciato
- Alimentazione elettrica da 220 V - 50 Hz
- Lampada fluorescente 20 W cad. (E 14)
- Raggio d'azione fino a 50 m<sup>2</sup>
- Metodo di cattura con carta moschicida
- Murale (H ideale 1,80/2,20 mt) o d'appoggio
- Silenzioso e inodore
- Conforme al metodo HACCP e a norma CE
- Classe di protezione: IP20

### Decorative flying insect killer with glue board

- Brushed s.steel or powder epoxy coated casing
- Power supply: 220 V - 50 Hz
- Fluo lamp 20 W each (E 14)
- Coverage area up to 50 m<sup>2</sup>
- Equipped with glue board
- Wall-mounted (H 1,80/2,20 mt) or on stand
- Quiet and odorless
- In compliance with HACCP method and CE requirements
- Protection class: IP20

- 💡 1x20 W (E14)
- m<sup>2</sup> 50 m<sup>2</sup>
- W 20 W max
- 👤 1,2 Kg
- 🔌 220 V / 50 Hz



300 mm  
75 mm  
200 mm



Varianti colore / Colors available



Sterminatore insetti inox satinato 20 W <i>Insect killer brushed s. steel 20 W</i>	<b>903120</b>
Sterminatore insetti acciaio nero 20 W <i>Insect killer black steel 20 W</i>	<b>903121</b>
Sterminatore insetti acciaio bianco 20 W <i>Insect killer white steel 20 W</i>	<b>903123</b>
Ricambio carta moschicida 160x195 mm <i>Spare glue board 160x195 mm</i>	<b>903093</b>
Lampada fluo 20 W (E 14) <i>Fluo lamp 20 W (E 14)</i>	<b>903057</b>





## INSETTIVOR FLUO

### Sterminatori d'insetti con carta moschicida

- Corpo in acciaio inox satinato
- Alimentazione elettrica da 220 V - 50 Hz
- Lampade fluorescenti a basso consumo (20 W cad.)
- Vita utile delle lampade: fino a 5.000 ore
- Raggio d'azione fino a 100 m<sup>2</sup> o a 200 m<sup>2</sup>
- Metodo di cattura con carta moschicida
- Possibilità di installazione a muro, a sospensione o d'appoggio
- Kit di montaggio e catena non inclusi
- Conforme al metodo HACCP e a norma CE
- Classe di protezione: IP20

### Flying insect killer with glue board

- Brushed stainless steel casing
- Power supply: 220 V - 50 Hz
- Low consumption fluorescent bulb (20 W each)
- Lamp life: 5.000 hrs approximately
- Coverage area: up to 100 m<sup>2</sup> or 200 m<sup>2</sup>
- Equipped with glue board
- Wall mounted, ceiling suspended or freestanding
- Mounting kit and chain not included
- In compliance with HACCP method and CE requirements
- Protection class: IP20

- 💡 2x20 W (E14)
- m<sup>2</sup> 100 m<sup>2</sup>
- W 40 W max
- 👤 2,5 Kg
- 🔌 220 V / 50 Hz



260 mm  
125 mm  
265 mm

- 💡 4x20 W (E14)
- m<sup>2</sup> 200 m<sup>2</sup>
- W 80 W max
- 👤 3 Kg
- 🔌 220 V / 50 Hz



260 mm  
125 mm  
330 mm



Sterminatore d'insetti inox satinato 40 W fluo <i>Insect killer brushed s.steel 40 W fluo</i>	<b>903076</b>
Ricambio carta 195x240 mm <i>Spare glue board 195x240 mm</i>	<b>903090</b>
Sterminatore d'insetti inox satinato 80 W fluo <i>Insect killer brushed s.steel 80 W fluo</i>	<b>903077</b>
Ricambio carta 195x310 mm <i>Glue board 195x310 mm</i>	<b>903091</b>
Ricambio lampada fluo 20 W (E14) <i>Fluo lamp 20 W (E14)</i>	<b>903057</b>

## INSETTIVOR FLUO

### Sterminatori d'insetti con griglia

- Corpo in acciaio inox satinato o metallo verniciato bianco
- Alimentazione elettrica da 220 V - 50 Hz
- Lampade fluorescenti 20 W cad. (E14)
- Vita utile delle lampade: fino a 5.000 ore
- Raggio d'azione fino a 50 m<sup>2</sup> o 120 m<sup>2</sup>
- Metodo di cattura con griglia elettrica (3.000 V)
- Possibilità d'installazione a muro, a sospensione o d'appoggio
- Kit d'installazione e catena inclusi
- Conforme a norma CE e metodo HACCP
- Classe di protezione: IP20

### Flying insect killer with electric grid

- Brushed stainless steel or white coated steel
- Power supply: 220 V - 50 Hz
- Fluo lamps 20 W each (E14)
- Lamp life: 5.000 hrs approximately
- Coverage area: up to 50 m<sup>2</sup> or 120 m<sup>2</sup>
- Equipped with electric grid (3.000 V)
- Wall mounted, ceiling suspended or free standing
- Fixing kit and chain included
- In compliance with CE requirements and HACCP method
- Protection class: IP20

- 💡 1x20 W (E14)
- m<sup>2</sup> 50 m<sup>2</sup>
- W 20 W max
- 👤 3 Kg
- 🔌 220 V / 50 Hz



260 mm  
125 mm  
265 mm

- 💡 2x20 W (E14)
- m<sup>2</sup> 120 m<sup>2</sup>
- W 40 W max
- 👤 3,6 Kg
- 🔌 220 V / 50 Hz



260 mm  
125 mm  
330 mm



Varianti colore / Colors available

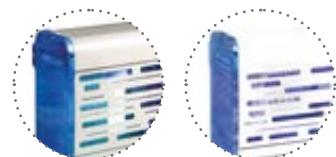

Sterminatore d'insetti inox-blu 20 W fluo <i>Insect killer s.steel-blue - 20 W fluo</i>	<b>903071</b>
Sterminatore d'insetti inox-blu 40 W fluo <i>Insect killer s.steel-blue - 40 W fluo</i>	<b>903073</b>
Sterminatore d'insetti acciaio bianco-blu 40 W fluo <i>Insect killer white steel-blue 40 W fluo</i>	<b>903074</b>
Ricambio lampada fluo 20 W (E14) <i>Fluo lamp 20 W (E14)</i>	<b>903057</b>



## INSETTIVOR NEON

### Sterminatori d'insetti con carta moschicida

- Corpo in acciaio inox satinato
- Alimentazione elettrica da 220 V - 50 Hz
- Tubo al neon (15 W cad.)
- Raggio d'azione fino a 80 m<sup>2</sup>
- Metodo di cattura con carta moschicida
- Possibilità d'installazione a muro, a sospensione o d'appoggio
- Kit d'installazione e catena inclusi
- Conforme al metodo HACCP e a norma CE
- Classe di protezione: IP20

### Flying insect killer with glue board

- Brushed stainless steel casing
- Power supply: 220 V - 50 Hz
- Low consumption neon tube (15 W each)
- Coverage area up to 80 m<sup>2</sup>
- Equipped with glue board
- Wall mounted, ceiling suspended or free standing
- Fixing kit and chain included
- In compliance with HACCP method and CE requirements
- Protection class: IP20



- 💡 2x15 W (43 cm neon)
- m<sup>2</sup> 80 m<sup>2</sup>
- W 30 W max
- 👤 4,6 Kg
- 🔌 220 V / 50 Hz



- 300 mm
- 160 mm
- 510 mm

Sterminatore d'insetti inox satinato 30 W fluo <i>Insect killer brushed s.steel 30 W fluo</i>	<b>903009</b>
Ricambio carta 195x460 mm <i>Glue board 195x460 mm</i>	<b>903092</b>
Ricambio neon 15 W (43 cm) <i>Neon tube 15 W (43 cm)</i>	<b>903053</b>

## INSETTIVOR TRAP

### Sterminatori d'insetti per uso intensivo

- Corpo in acciaio inox AISI 304 satinato
- Alimentazione elettrica da 220 V - 50 Hz
- Lampade al neon anti-scoppio (15 o 36 W cad.)
- Raggio d'azione fino a 80 m<sup>2</sup> o 240 m<sup>2</sup>
- Metodo di cattura con carta moschicida
- Fissaggio a muro o in sospensione
- Catena e ferro a muro in dotazione
- Ideale per industrie agro-alimentari
- Conforme al metodo HACCP e a norma CE
- Classe di protezione: IP20

### Flying insect killer with glue board

- AISI 304 brushed stainless steel casing
- Power supply: 220 V - 50 Hz
- Shatterproof neon tubes (15 or 36 W each)
- Coverage area up to 80 m<sup>2</sup> or 240 m<sup>2</sup>
- Equipped with glue board
- Wall mounted or ceiling suspended (kit included)
- Chain and bracket included
- Ideal for food and agricultural industry
- In compliance with HACCP method and CE requirements
- Protection class: IP20

- 💡 2x15 W (43 cm neon)  
antiscoppio/anti-exploding
- m<sup>2</sup> 80 m<sup>2</sup>
- W 30 W max
- 👤 3,2 Kg
- 🔌 220 V / 50 Hz



- 160 mm
- 355 mm
- 465 mm

- 💡 2x36 W (61 cm neon)  
antiscoppio/anti-exploding
- m<sup>2</sup> 240 m<sup>2</sup>
- W 72 W max
- 👤 5 Kg
- 🔌 220 V / 50 Hz



- 160 mm
- 355 mm
- 620 mm



Sterminatore d'insetti inox 304 - 30 W neon <i>Insect killer 304 s.steel - 30 W neon</i>	<b>903081</b>
Tubo neon 15 W <i>Neon tube 15 W</i>	<b>903088</b>
Ricambio carta moschicida (363x456 mm) <i>Glue board (363x456 mm)</i>	<b>903048</b>
Sterminatore d'insetti inox 304 - 72 W neon <i>Insect killer 304 s.steel 304 s.steel - 72 W neon</i>	<b>903082</b>
Tubo neon 36 W <i>Neon tube 36 W</i>	<b>903089</b>
Ricambio carta moschicida (364x598 mm) <i>Glue board (364x598 mm)</i>	<b>903049</b>



## INSECTIVORO

### Sterminatori d'insetti per ambienti di medie dimensioni

- Antizzanzare ad aspirazione in polycarbonato e ABS grigio
- Alimentazione elettrica da 230 V - 50 Hz
- Lampada di ricambio da 32 W
- Raggio d'azione di circa 14-16 m lineari
- Motore silenzioso a 1 velocità
- Perfetto per la ristorazione
- Ampio cassetto di recupero insetti
- Conforme al metodo HACCP, norma CE, normativa EN-60335-2-80
- Classe di protezione: II

### Flying insect killer for medium environments

- Grey polycarbonate and ABS casing
- Power supply: 230 V - 50 Hz
- 32 W lamp as a spare part
- Coverage area up to linear 14-16 m
- 1 speed silence motor
- Perfect for catering
- Large insect recovery drawer
- In compliance with HACCP method, CE requirements, EN-60335-2-80 regulation
- Protection class: II



Aspiratore  
Aspirator



Lampada 32 W  
32 W Lamp

- 💡 1x32 W (E14)
- m 14-16 m
- W 55 W max
- 👤 2,4 Kg
- 🔌 230 V / 50 Hz

340 mm  
220 mm  
245 mm



Sterminatore d'insetti in PC e ABS grigio  
Grey PC and ABS flying insect killer  
Lampada di ricambio 32 W  
Lamp 32 W as a spare part

703101

703151

## RICAMBI STERILIZZATORI E STERMINATORI INSETTI STERILIZER AND INSECT KILLERS SPARE PARTS

### Carte moschicida / Glue boards

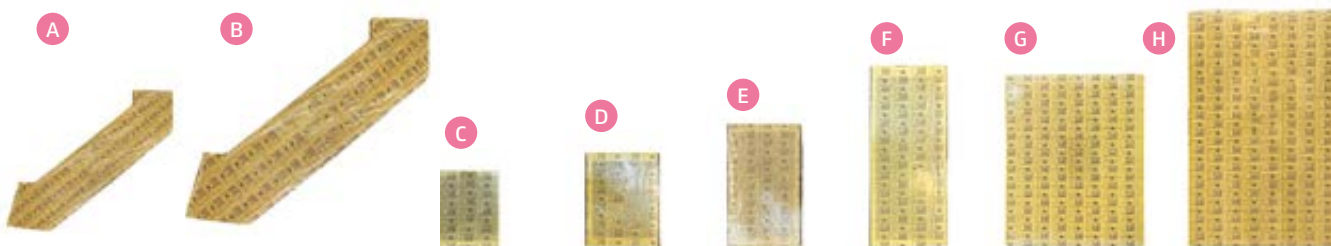

<b>A</b>	Ricambio "Applique 20 W" - 180x465 mm "Applique 20 W" refill - 180x465 mm	903047
<b>B</b>	Ricambio "Applique 40 W" - 205x785 mm "Applique 40 W" Spare - 205x785 mm	903045
<b>C</b>	Ricambio "Iglu" - 160x195 mm "Iglu" refill - 160x195 mm	903093
<b>D</b>	Ricambio "Insettivor Fluo" 195x240 mm "Insettivor Fluo" refill - 195x240 mm	903090

<b>E</b>	Ricambio "Insettivor Fluo" - 195x310 mm "Insettivor Fluo" refill - 195x310 mm	903091
<b>F</b>	Ricambio "Insettivor Neon" - 195x460 mm "Insettivor Neon" refill - 195x460 mm	903092
<b>G</b>	Ricambio "Insettivor Trap 30 W" - 363x456 mm "Insettivor Trap 30 W" refill - 363x456 mm	903048
<b>H</b>	Ricambio "Insettivor Trap 72 W" - 364x598 mm "Insettivor Trap 72 W" refill - 364x598 mm	903049

### Lampade / Lamps



<b>I</b>	Lampada UVC per STERY e STERY KS UVC lamp for STERY and STERY KS	903054
<b>L</b>	Lampada fluo 20 W (E 14) Fluo lamp 20 W (E 14)	903057
<b>M</b>	Ricambio neon 15 W (43 cm) x INSETTIVOR NEON Neon tube 15 W (43 cm) for INSETTIVOR NEON	903053

<b>N</b>	Tubo neon 15 W x INSETTIVOR TRAP 30 W Neon tube 15 W for INSETTIVOR TRAP 30 W	903088
<b>O</b>	Tubo neon 36 W x INSETTIVOR TRAP 72 W Neon tube 36 W for INSETTIVOR TRAP 72 W	903089
<b>P</b>	Lampada di ricambio 32 W x INSECTIVORO Lamp 32 W as a spare part for INSECTIVORO	703151



## PIRETRO

250 ml



140 mm  
65 mm  
65 mm

### Spray dissuasore per insetti

- Dissuasore spray pronto all'uso in bomboletta da 250 ml
- Rapido effetto abbattente su insetti volanti e striscianti
- Particolarmente indicato per l'uso nei dispenser automatici
- Può anche essere impiegato manualmente
- Estratto di piretro 7,2 g (pari a 1,8% di piretrine pure)

### Insect deterrent spray

- Ready-to-use deterrent 250 ml
- Quick knock-down effect on flying and crawling insects
- Ideal for use in automatic dispensers, can also be used manually
- It can also be used manually
- Pyrethrum concentration 7.2% (equal to 1,8% piretrine pure)



## MALÌA STOP

250 ml



CITRONELLA  
LEMONGRASS

140 mm  
65 mm

### Spray dissuasore per insetti

- Formulazione a base di oli essenziali di citronella e tea tree
- Profuma piacevolmente gli ambienti
- Crea una barriera olfattiva che tiene lontani gli insetti
- Conforme alle normative vigenti in tema di prodotti aerosol
- Compatibile con gran parte dei diffusori presenti sul mercato
- Bomboletta da 250 ml (2.500 spruzzi - conf. 12 pz)
- Pronto all'uso

### Insect deterrent spray

- Formulation based on citronella and tea tree essential oils
- Provides a pleasant scent to the environment
- Creates an olfactory barrier that keeps insects away
- Compliant with current regulations on aerosol products
- Fit in most dispenser on the market
- Cans include 250 ml of fragrance (2.500 sprays - box of 12 pcs)
- Ready to use



Secchio doppiavasca con strizzatore 30 L  
Double bucket mop trolley with wringer 30 L

707010

Spray dissuasore per insetti  
Insect deterrent spray

797004

**Per un corretto funzionamento di PIRETRO e MALÌA STOP ne consigliamo l'utilizzo con:**  
**For proper functioning of PIRETRO and MALÌA STOP, we recommend their use with:**



### BASICA

**Diffusore automatico di profumo**  
**Automatic air freshener**

(vedi pag. 128 / see page 128)

REF. 104060



### SOFFIO

**Diffusore automatico di profumo**  
**Automatic air freshener**

(vedi pag. 129 / see page 129)

REF. 110540



### BASICA

**Diffusore digitale automatico di profumo**  
**Digital air freshener**

(vedi pag. 128 / see page 128)

REF. 104062



### SOFFIO

**Diffusore automatico di profumo**  
**Automatic air freshener**

(vedi pag. 129 / see page 129)

REF. 110542

\*Compatibili anche con gran parte dei diffusori presenti sul mercato / \*Fit in most dispenser on the market





## IGIENE E CURA DELLA PERSONA HYGIENE AND PERSONAL CARE SOLUTIONS

P. **61**  LINEA SUPERB  
SUPERB RANGE

P. **106**  LINEA STILECO  
STILECO RANGE

P. **123**  DIFFUSORI DI  
PROFUMO  
AIR FRESHENERS

P. **67**  LINEA BRINOX  
BRINOX RANGE

P. **110**  DISTRIBUTORI  
CARTA IN BOBINE  
CENTER PULL  
TOWEL DISPENSERS

P. **132**  POSTAZIONI  
IGIENIZZANTI  
SANITIZING STATIONS

P. **80**  LINEA PURA  
PURA RANGE

P. **114**  FASCIATOI PER NEONATI  
BABY CHANGING TABLES

P. **136**  PROTEZIONE INDIVIDUALE  
PERSONAL PROTECTIVE  
EQUIPMENT

P. **84**  LINEA NOIR  
NOIR RANGE

P. **115**  ACCESSORI BAGNO  
SIMPLY  
BELLA BATHROOM  
ACCESSORIES

P. **139**  MATERIALI  
DI CONSUMO  
CONSUMABLES

P. **92**  LINEA BASICA  
BASICA RANGE

P. **116**  ACCESSORI BAGNO  
KATY  
KATY BATHROOM  
ACCESSORIES

P. **143**  KIT PRIMO SOCCORSO  
FIRST AID KITS

P. **102**  LINEA WAVE  
WAVE RANGE

P. **118**  SPECCHI  
MIRRORS

P. **147**  ASCIUGAMANI ELETTRICI  
HAND DRYERS

P. **104**  LINEA WAVE<sup>2</sup>  
WAVE<sup>2</sup> RANGE

P. **120**  ACCESSORI WC  
WC ACCESSORIES

P. **165**  ASCIUGACAPELLI  
HAIR DRYERS





## LINEA SUPERB

### SUPERB RANGE



Distributori carta asciugamani  
Paper towel dispenser



Distributore sapone liquido  
Liquid soap dispensers



Distributore sapone a schiuma  
Foam soap dispensers



Distributori carta igienica in rotolo  
Toilet roll dispensers



Distributori carta igienica interfogliata  
Interfold toilet tissue dispensers



Gettacarte murale  
Wall mount waste bin





## SUPERB

400  
F



376 mm  
126 mm  
286 mm



Punto d'estrazione  
Release of paper



Carta piegata C o Z  
C,Z-folded towels

### Distributore di carta asciugamani (400 fogli)

- Base in ABS e cover in inox 304 satinato
- Per carta asciugamani piegata a C o Z
- Capienza fino a 400 fogli
- Bocchetta d'estrazione ergonomica in plastica
- Erogazione ottimizzata "foglio a foglio"
- Visore di controllo del livello della carta
- Sistema di chiusura a scatto
- Chiave universale in plastica
- Viteria inox inclusa

### Hand towel dispenser (400 sheets)

- ABS backing and 304 brushed s.steel
- Holds C or Z-fold paper towel
- Capacity up to 400 sheets
- Ergonomic dispensing slot from ABS
- Optimized release of paper
- Front viewer to monitor paper level
- Secured by a closing system
- Universal plastic key
- Stainless steel fixing hardware included



Distributore carta asciugamani 400 fogli (c,z)  
Hand towel dispenser 400 sheets (c,z-folded)

105810

## SUPERB

400  
F



376 mm  
140 mm  
286 mm



Punto d'estrazione  
Release of paper



Carta piegata C,Z,V  
C,Z,V-folded towels

### Distributore di carta asciugamani (400 fogli)

- Base in ABS e cover in inox 304 satinato
- Per carta asciugamani piegata a C, Z e V
- Capienza fino a 400 fogli
- Bocchetta d'estrazione ergonomica in plastica
- Erogazione ottimizzata "foglio a foglio"
- Visore di controllo del livello della carta
- Sistema di chiusura a scatto
- Chiave universale in plastica
- Viteria inox inclusa

### Hand towel dispenser (400 sheets)

- ABS backing and 304 brushed s.steel
- Holds C, Z or V-fold paper towel
- Capacity up to 400 sheets
- Ergonomic dispensing slot from ABS
- Optimized release of paper
- Front viewer to monitor paper level
- Secured by a closing system
- Universal plastic key
- Stainless steel fixing hardware included



DISPONIBILE IN AR SU MEDIAL APP  
AVAILABLE IN AR ON MEDIAL APP



Distributore carta asciugamani 400 fogli (c,z,v)  
Hand towel dispenser 400 sheets (c,z,v-folded)

105815



## SUPERB

1 L

1,5 ml



Erogazione "push"  
Push-operated



260 mm  
95 mm  
118 mm

### Distributore di sapone liquido

- Base in ABS e cover in inox 304 satinato
- Serbatoio in plastica a riempimento da 1 L
- Per sapone liquido (privo di microgranuli)
- Sistema d'erogazione "push"
- Visore di controllo del livello del sapone
- Sistema di chiusura a scatto
- Chiave universale in plastica
- Viteria inox inclusa

### Liquid soap dispenser

- ABS backing and 304 brushed s.steel
- Refillable plastic tank 1 L
- Suitable for liquid soaps (no microbeads)
- Push dispensing system
- Front viewer to monitor soap level
- Secured by a closing system
- Universal plastic key
- Stainless steel fixing hardware included



DISPONIBILE IN AR SU MEDIAL APP  
AVAILABLE IN AR ON MEDIAL APP



Punto d'erogazione  
Dispensing point



Tanica a riempimento  
Refillable tank

Distributore di sapone liquido 1 L  
Liquid soap dispenser 1 L

105830

## SUPERB

1 L

1,5 ml

Erogazione "push"  
Push-operated



260 mm  
95 mm  
118 mm

### Distributore di sapone a schiuma

- Base in ABS e cover in inox 304 satinato
- Serbatoio in plastica a riempimento da 1 L
- Per sapone a schiuma
- Sistema d'erogazione "push"
- Visore di controllo del livello del sapone
- Sistema di chiusura a scatto
- Chiave universale in plastica
- Viteria inox inclusa

### Foam soap dispenser

- ABS backing and 304 brushed s.steel
- Refillable plastic tank 1 L
- Suitable for foam soap
- Push dispensing system
- Front viewer to monitor soap level
- Secured by a closing system
- Universal plastic key
- Stainless steel fixing hardware included



Punto d'erogazione  
Dispensing point



Tanica a riempimento  
Refillable tank

Distributore di sapone a schiuma 1 L  
Foam soap dispenser 1 L

105835



## SUPERB

200  
M



282 mm  
133 mm  
265 mm



Mandrino  
Spindle



Tre lame tagliacarta  
Three blades

### Distributore di carta igienica in rotolo (200 m)

- Base in ABS e cover in inox 304 satinato
- Per rotoli fino a 200 m (max. Ø rotolo 240 mm)
- Mandrino in plastica con Ø 32 mm
- Adattatore per mandrino con Ø 70 mm
- Taglio carta facilitato sui tre lati
- Visore di controllo del livello della carta
- Sistema di chiusura a scatto
- Chiave universale in plastica
- Viteria inox inclusa

### Mini jumbo toilet roll dispenser (200 m)

- ABS backing and 304 brushed s.steel
- Holds up to 200 m toilet paper roll (max. Ø 240 mm)
- Plastic spindle with Ø 32 mm
- Adapter for mandrin with Ø 70 mm
- Three blades for easy paper cut
- Front viewer to monitor paper level
- Secured by a closing system
- Universal plastic key
- Stainless steel fixing hardware included



Distributore carta igienica in rotolo 200 m  
Mini jumbo toilet roll dispenser 200 m

105800

## SUPERB

400  
M



329 mm  
133 mm  
265 mm



Mandrino  
Spindle



Tre lame tagliacarta  
Three blades

### Distributore di carta igienica in rotolo (400 m)

- Base in ABS e cover in inox 304 satinato
- Per rotoli fino a 400 m (max. Ø rotolo 290 mm)
- Mandrino in plastica con Ø 32 mm
- Adattatore per mandrino con Ø 70 mm
- Taglio carta facilitato sui tre lati
- Visore di controllo del livello della carta
- Sistema di chiusura a scatto
- Chiave universale in plastica
- Viteria inox inclusa

### Maxi jumbo toilet roll dispenser (400 m)

- ABS backing and 304 brushed s.steel
- Holds up to 400 m toilet paper roll (max. Ø 290 mm)
- Plastic spindle with Ø 32 mm
- Adapter for mandrin with Ø 70 mm
- Three blades for easy paper cut
- Front viewer to monitor paper level
- Secured by a closing system
- Universal plastic key
- Stainless steel fixing hardware included



DISPONIBILE IN AR SU MEDIAL APP  
AVAILABLE IN AR ON MEDIAL APP



Distributore carta igienica in rotolo 400 m  
Maxi jumbo toilet roll dispenser 400 m

105805



## SUPERB

500  
F



227 mm  
135 mm  
146 mm

### Distributore di carta igienica interfogliata

- Base in ABS e cover in inox 304 satinato
- Per carta igienica interfogliata
- Capienza fino a 500 fogli
- Bocchetta d'estrazione in plastica
- Erogazione a singolo foglio per la massima igiene
- Visore di controllo del livello della carta
- Sistema di chiusura a scatto
- Chiave universale in plastica
- Viteria inox inclusa

### Interfold toilet tissue dispenser

- ABS backing and 304 brushed s.steel
- Holds interfold toilet tissues
- Capacity up to 500 sheets
- Ergonomic dispensing slot from ABS
- Optimized and hygienic release of paper
- Front viewer to monitor paper level
- Secured by a closing system
- Universal plastic key
- Stainless steel fixing hardware included



DISPONIBILE IN AR SU MEDIAL APP  
AVAILABLE IN AR ON MEDIAL APP



Punto d'estrazione  
Release of paper



Carta interfogliata  
Interfold toilet tissue

Distributore carta igienica interfogliata 500 fogli  
Interfold toilet tissue dispenser 500 sheets

105820

## MILUNA

40  
L

60  
L

20  
L

30  
L



647 mm  
195 mm  
395 mm



388 mm  
195 mm  
395 mm

### Gettacarte murale

- Acciaio inox satinato
- Elastico fermasacco
- Fissaggio murale
- Viteria non inclusa

### Wall mount waste bin

- Stainless steel, brushed finish
- Bag held in place by elastic band
- Wall mounted fastening
- Fixing hardware not included



DISPONIBILE IN AR SU MEDIAL APP  
AVAILABLE IN AR ON MEDIAL APP



Gettacarte murale inox satinato  
Brushed s.steel wall mounted waste bin

20 L

40 L

773036

773046





## LINEA BRINOX

### BRINOX RANGE



Distributori carta asciugamani  
Paper towel dispensers



Distributori automatici  
sapone e igienizzante  
Automatic dispensers  
soap and hand sanitizer



Distributori sapone liquido  
Liquid soap dispensers



Distributore sapone a schiuma  
Foam soap dispensers



Distributori igienica in rotolo  
Toilet roll paper dispensers



Distributori igienica interfogliata  
Interfold toilet tissue dispensers



Portarotoli  
Toilet paper holders



Portascopini  
Toilet brush holders



Distributori carta copriwater  
Toilet seat cover dispensers



Distributori per sacchetti  
igienici in carta  
Paper sanitary towel  
bag dispensers



Distributori per sacchetti  
igienici in plastica  
Plastic sanitary towel  
bag dispensers



Portafazzoletti rettangolare  
Rectangular tissue holders



Portafazzoletti quadrato  
Square tissue holders



Distributori guanti  
Gloves dispensers



Gettacarte  
Paper bins



Pattumiere a pedale  
Pedal waste bins



## BRINOX

400  
F

200  
F



350 mm  
102 mm  
280 mm

250 mm  
102 mm  
280 mm



### Distributore di carta asciugamani (200/400 fogli)

- Acciaio inox AISI 430 brillante o AISI 304, con finitura brillante o satinata
- Per carta asciugamani piegata a C o Z
- Capienza fino a 200 o 400 fogli
- Visore di controllo del livello della carta
- Serratura antivandalo in metallo
- Viteria inox inclusa

### Hand towel dispenser (200/400 sheets)

- AISI 430 polished s.steel or AISI 304 s.steel, with polished or brushed finish
- Holds C or Z-fold paper towel
- Capacity up to 200 or 400 sheets
- Front viewing window to monitor paper level
- Vandal-proof stainless steel keyed lock
- Stainless steel fixing hardware included

	200 F	400 F
Inox AISI 430 brillante <i>AISI 430 polished s.steel</i>	105011	105016
Inox AISI 304 brillante <i>AISI 304 polished s.steel</i>	105012	105017
Inox AISI 304 satinato <i>AISI 304 brushed s.steel</i>	105013	105019



## BRINOX

500  
F



400 mm  
125 mm  
280 mm

### Distributore di carta asciugamani (500 fogli)

- Acciaio inox AISI 304, con finitura brillante
- Per carta asciugamani piegata a C, Z o V
- Capienza fino a 500 fogli
- Visore di controllo del livello della carta
- Serratura antivandalo in metallo
- Viteria inox inclusa

### Hand towel dispenser (500 sheets)

- AISI 304 stainless steel, with polished finish
- Holds C Z or V-fold paper towel
- Capacity up to 500 sheets
- Front viewing window to monitor paper level
- Vandal-proof stainless steel keyed lock
- Stainless steel fixing hardware included



Inox AISI 304 brillante  
*AISI 304 polished s.steel*

105015



## BRINOX SENSOR

1 L

1,5 ml

Sapone liquido / gel igienizzante  
*Liquid soap / hand sanitizer gel*



257 mm  
100 mm  
141 mm

### Distributori automatici di sapone e/o gel igienizzante

- Acciaio inox AISI 304, con finitura brillante o satinata
- Tanica in plastica a riempimento da 1 L
- Versione per sapone liquido (no microgranuli) o gel igienizzante
- Versione per sapone a schiuma
- Versione per soluzioni igienizzanti liquide
- Sistema di erogazione automatica con sensore a infrarossi
- Alimentazione: 4 pile tipo "AA" da 1,5 V (non comprese)
- Alimentatore di corrente 110-240 V / 6 V (non incluso)
- Installazione a minimo 30 cm dal lavabo
- Serratura antivandalo in metallo
- Viteria inox inclusa

### Automatic dispensers for soap and/or alcohol-based cleaner

- AISI 304 stainless steel, with polished or brushed finish
- Refillable plastic tank 1 L
- Suitable for liquid soap (no microbeads) or hand sanitizer gel
- Suitable for foam soap (mixture of 65% water and 35% non-creamy soap)
- Suitable for liquid sanitizer
- Infrared sensor operated
- Operates on four 1,5 V "AA" cell batteries (not included)
- AC adapter 110-240 V / 6 V (not included)
- To be installed at least 30 cm from the sink
- Vandal-proof stainless steel keyed lock
- Stainless steel fixing hardware included



1 L

1,5 ml

Sapone a schiuma  
*Foam soap*



257 mm  
100 mm  
141 mm

1 L

0,9 ml

Spray igienizzante liquido  
*Spray sanitizer*



257 mm  
100 mm  
141 mm

	Inox AISI 304 brillante <i>AISI 304 polished s.steel</i>	Inox AISI 304 satinato <i>AISI 304 brushed s.steel</i>
Sapone liquido / gel igienizzante <i>Liquid soap / hand sanitizer gel</i>	104530	104531
Sapone a schiuma <i>Foam soap</i>	104532	104533
Spray igienizzante liquido <i>Spray sanitizer</i>	104534	104535
Alimentatore di corrente <i>AC adapter</i>	104950	104950





## BRINOX

0,5  
L

1,8 ml

Sistema "pull"  
Pull-operated



225 mm  
105 mm  
95 mm

### Distributore di sapone liquido

- Acciaio inox AISI 304, con finitura brillante o satinata
- Tanica in plastica a riempimento da 0,5 L
- Per tutti i tipi di sapone, salvo a microgranuli
- Sistema di erogazione "pull"
- Visore di controllo del livello del sapone
- Serratura antivandalo in metallo
- Viteria inox inclusa

### Liquid soap dispenser

- AISI 304 stainless steel, with polished or brushed finish
- Refillable plastic tank 0,5 L
- For all kind of liquid soaps, except for microbead soaps
- Pull-operated anti-drip pump
- Front viewing window to monitor soap level
- Vandal-proof stainless steel keyed lock
- Stainless steel fixing hardware included



Inox AISI 304 brillante  
AISI 304 polished s. steel

104036

Inox AISI 304 satinato  
AISI 304 brushed s. steel

104037

## BRINOX

1,2  
L

1,8 ml

Sistema "pull"  
Pull-operated



320 mm  
110 mm  
100 mm

1,2  
L

1,8 ml

Mod. Hospital  
Sistema "a gomito"  
Elbow-operated



320 mm  
170 mm  
125 mm

### Distributore di sapone liquido

- Acciaio inox AISI 304, con finitura brillante o satinata
- Tanica in plastica a riempimento da 1,2 L
- Per tutti i tipi di sapone, salvo a microgranuli
- Sistema di erogazione "pull" o a gomito (mod. Hospital)
- Visore di controllo del livello del sapone
- Serratura antivandalo in metallo
- Viteria inox inclusa

### Liquid soap dispenser

- AISI 304 stainless steel, with polished or brushed finish
- Refillable plastic tank 1,2 L
- For all kind of liquid soaps, except for microbead soaps
- Pull or elbow-operated (hospital) anti-drip pump
- Front viewing window to monitor soap level
- Vandal-proof stainless steel keyed lock
- Stainless steel fixing hardware included



Inox AISI 304 brillante  
AISI 304 polished s. steel

105036

Inox AISI 304 satinato  
AISI 304 brushed s. steel

105037

Hospital - Inox AISI 304 brillante  
AISI 304 polished s. steel - Hospital

105038

Hospital - Inox AISI 304 satinato  
AISI 304 brushed s. steel - Hospital

105039



## BRINOX

1,2  
L

1,8 ml

Sistema "pull"  
Pull-operated



295 mm  
105 mm  
98 mm

### Distributore di sapone a schiuma

- Acciaio inox AISI 304, con finitura brillante o satinata
- Tanica in plastica a riempimento da 1,2 L per sapone a schiuma
- Sistema di erogazione "pull"
- Visore di controllo del livello del sapone
- Serratura antivandalo in metallo
- Viteria inox inclusa

### Foam soap dispenser

- AISI 304 stainless steel, with polished or brushed finish
- Refillable plastic tank 1,2 L for foam soap
- Pull-operated anti-drip pump
- Front viewing window to monitor soap level
- Vandal-proof stainless steel keyed lock
- Stainless steel fixing hardware included



Inox AISI 304 brillante  
AISI 304 polished stainless steel

104030

Inox AISI 304 satinato  
AISI 304 brushed stainless steel

104031

## BRINOX

1,2  
L

1,5 ml

Sistema "push"  
Push-operated



205 mm  
105 mm  
130 mm

0,8  
L

1,5 ml

Sistema "push"  
Push-operated



180 mm  
100 mm  
115 mm

### Distributore di sapone liquido

- Acciaio inox AISI 304, con frontale satinato e laterale brillante
- Serbatoio fuso nella struttura da 0,8 L o 1,2 L
- Per tutti i tipi di sapone, salvo a microgranuli
- Sistema di erogazione "push"
- Serratura in metallo
- Viteria inox inclusa

### Liquid soap dispenser

- AISI 304 stainless steel, with brushed cover and polished sides
- Refillable tank 0,8 L or 1,2 L
- For all kind of liquid soaps, except for microbead soaps
- Push-operated anti-drip pump
- Stainless steel keyed lock
- Stainless steel fixing hardware included



Inox AISI 304 - 0,8 L  
AISI 304 stainless steel - 0,8 L

105031

Inox AISI 304 - 1,2 L  
AISI 304 stainless steel - 1,2 L

105032



## BRINOX

200  
M



265 mm  
127 mm  
260 mm



Mandrino  
Spindle



Tre lame tagliacarta  
Three blades

### Distributore di carta igienica in rotolo (200 m)

- Acciaio inox AISI 430 brillante o AISI 304, con finitura brillante o satinata
- Per rotoli da 200 m (max. Ø rotolo 230 mm)
- Mandrino rettangolare in inox per limitare il consumo della carta
- Diagonale del mandrino: 55 mm
- Lame su tre lati per facilitare il taglio della carta
- Visore di controllo del livello della carta
- Serratura antivandalo in metallo
- Viteria inox inclusa

### Mini jumbo toilet roll dispenser (200 m)

- AISI 430 polished s.steel or AISI 304 s.steel, with polished or brushed finish
- Holds 200 mt toilet paper roll (max. 230 mm Ø)
- Rectangular spindle designed to minimize paper wastage
- Spindle diagonal: 55 mm
- Three blades for easy paper cut
- Front viewing window to monitor paper level
- Vandal-proof stainless steel keyed lock
- Stainless steel fixing hardware included



Inox AISI 430 brillante AISI 430 polished s.steel	105001
Inox AISI 304 brillante AISI 304 polished s.steel	105002
Inox AISI 304 satinato AISI 304 brushed s.steel	105003

## BRINOX

400  
M



320 mm  
130 mm  
310 mm



Mandrino  
Spindle



Tre lame tagliacarta  
Three blades

### Distributore di carta igienica in rotolo (400 m)

- Acciaio inox AISI 430 brillante o AISI 304, con finitura brillante o satinata
- Per rotoli da 400 m (max. Ø rotolo 300 mm)
- Mandrino rettangolare in inox per limitare il consumo della carta
- Diagonale del mandrino: 55 mm
- Lame su tre lati per facilitare il taglio della carta
- Visore di controllo del livello della carta
- Serratura antivandalo in metallo
- Viteria inox inclusa

### Maxi jumbo toilet roll dispenser (400 m)

- AISI 430 polished s.steel or AISI 304 s.steel, with polished or brushed finish
- Holds 400 m toilet paper roll (max. 300 mm Ø)
- Rectangular spindle designed to minimize paper wastage
- Spindle diagonal: 55 mm
- Three blades for easy paper cut
- Front viewing window to monitor paper level
- Vandal-proof stainless steel keyed lock
- Stainless steel fixing hardware included



Inox AISI 430 brillante AISI 430 polished s.steel	105006
Inox AISI 304 brillante AISI 304 polished s.steel	105007
Inox AISI 304 satinato AISI 304 brushed s.steel	105009



## BRINOX

500  
F

Doppio  
Double



270 mm  
120 mm  
133 mm

250  
F

Singolo  
Single



150 mm  
120 mm  
133 mm

### Distributore di carta igienica interfogliata

- Acciaio inox AISI 430 brillante o AISI 304, con finitura brillante o satinata
- Per carta igienica interfogliata
- Capacità: 250 fogli, 500 fogli
- Visore di controllo del livello della carta
- Serratura antivandalo in metallo
- Viteria inox inclusa

### Interfold toilet tissue dispenser

- AISI 430 polished s.steel or AISI 304 s.steel, with polished or brushed finish
- Holds interfold toilet tissues
- Capacity: 250 sheets, 500 sheets
- Front viewing window to monitor paper level
- Vandal-proof stainless steel keyed lock
- Stainless steel fixing hardware included



	250 F	500 F
Inox AISI 430 brillante <i>AISI 430 polished s.steel</i>	<a href="#">105024</a>	<a href="#">105029</a>
Inox AISI 304 brillante <i>AISI 304 polished s.steel</i>	<a href="#">105021</a>	<a href="#">105026</a>
Inox AISI 304 satinato <i>AISI 304 brushed s.steel</i>	<a href="#">105023</a>	<a href="#">105028</a>

## KATY

90 mm  
80 mm  
150 mm



55 mm  
165 mm  
120 mm



245 mm  
102 mm  
48 mm



### Portarotolo

- Acciaio inox AISI 304 brillante
- Utilizza 1 rotolo di tipo standard
- Mandrino in plastica
- Kit di fissaggio incluso

### Toilet paper holder for single roll

- AISI 304 polished stainless steel
- Holds 1 household toilet paper roll
- Plastic spindle
- Fixing kit included

Inox AISI 304 brillante  
*AISI 304 polished s.steel*

[105041](#)

### Portarotolo

- Acciaio inox AISI 304 brillante
- Utilizza 1 rotolo di tipo standard
- Mandrino in acciaio AISI 304

### Toilet paper holder for single roll

- AISI 304 polished stainless steel
- Holds 1 household toilet paper roll
- AISI 304 stainless steel spindle

Inox AISI 304 brillante - Katy  
*AISI 304 polished s.steel - Katy*

[105109](#)

### Portarotolo di riserva

- Acciaio inox AISI 304 brillante
- Utilizza 1 rotolo di tipo standard

### Toilet paper holder for single roll

- AISI 304 polished stainless steel
- Holds 1 household toilet paper roll

Inox AISI 304 brillante - Katy  
*AISI 304 polished s.steel - Katy*

[105112](#)





## BRINOX



### Portascopino

- Acciaio inox AISI 304, brillante o satinato
- Bacinella di recupero dei liquidi in plastica
- D'appoggio o murale (viteria inclusa)

### Toilet brush holder

- AISI 304 s.steel with polished or brushed finish
- Inner plastic tank for liquid collection
- Freestanding or wall-mounted
- Fixing hardware included

372 mm



Supporto murale  
Wall-mount holder

D'appoggio inox AISI 304 brillante Freestanding v. AISI 304 polished s.steel	<a href="#">130820</a>
D'appoggio inox AISI 304 satinato Freestanding v. AISI 304 brushed s.steel	<a href="#">130821</a>
Murale inox AISI 304 brillante Wall mounted v. AISI 304 polished s.steel	<a href="#">130822</a>
Murale inox AISI 304 satinato Wall mounted v. AISI 304 brushed s.steel	<a href="#">130823</a>

## TOP



390 mm



### Portascopino

- Acciaio inox AISI 304, brillante o satinato
- Bacinella di recupero dei liquidi in plastica
- Base in plastica

### Toilet brush holder

- AISI 304 s.steel with polished or brushed finish
- Inner plastic tank for liquid collection
- Plastic base

Inox AISI 304 brillante AISI 304 polished s.steel	<a href="#">101811</a>
Inox AISI 304 satinato AISI 304 brushed s.steel	<a href="#">101812</a>

## KATY



440 mm



### Portascopino murale

- Acciaio inox AISI 304 brillante
- Apertura automatica del coperchio
- Manico privo di coperchio
- Bacinella di recupero dei liquidi in plastica
- Viteria inclusa

### Wall-mounted toilet brush holder

- AISI 304 stainless steel, polished finish
- Automatic top opening
- Handle without top
- Inner plastic tank for liquid collection
- Fixing hardware included

Inox AISI 304 brillante AISI 304 polished s.steel	<a href="#">105108</a>
--	------------------------

## KATY



400 mm



### Portascopino murale

- Acciaio inox AISI 304 brillante
- Base in vetro
- Manico privo di coperchio
- Viteria inclusa

### Wall-mounted toilet brush holder

- AISI 304 stainless steel, polished finish
- Glass holder
- Handle without top
- Fixing hardware included

Vetro-Inox AISI 304 brillante Glass-AISI 304 polished s.steel	<a href="#">105115</a>
--	------------------------

## BASIC METAL MURAL



390 mm



Supporto murale  
Wall-mount holder

### Portascopino murale

- Acciaio inox brillante o satinato
- Bacinella di recupero dei liquidi in plastica
- Fissaggio murale in 2 punti
- Viteria inclusa

### Wall-mounted toilet brush holder

- S.steel, polished or brushed finish
- Inner plastic tank for liquid collection
- Wall mount bracket with 2 fixing points
- Fixing hardware included



Inox brillante Polished s.steel	<a href="#">101802</a>
Inox satinato Brushed s.steel	<a href="#">101807</a>

## BASIC METAL



390 mm



### Portascopino

- Acciaio inox brillante o satinato
- Bacinella di recupero dei liquidi in plastica

### Toilet brush holder

- S.steel, polished or brushed finish
- Inner plastic tank for liquid collection



Inox brillante Polished s.steel	<a href="#">101800</a>
Inox satinato Brushed s.steel	<a href="#">101805</a>



## BRINOX



137 mm  
25 mm  
98 mm

### Distributore sacchetti igienici in plastica

- Acciaio inox AISI 304, brillante o satinato
- Murale o d'appoggio
- Utilizza sacchetti in HDPE (cod. 799002)
- Viteria inox inclusa

### Plastic sanitary towel bag dispenser

- AISI 304 s. steel, with polished or brushed finish
- Wall mounted fastening or freestanding
- For HDPE sanitary bags (cod. 799002)
- Stainless steel fixing hardware included

Inox AISI 304 brillante  
AISI 304 polished s.steel

130006

Inox AISI 304 satinato  
AISI 304 brushed s.steel

130007

## BRINOX



280 mm  
40 mm  
130 mm

### Distributore sacchetti igienici in carta

- Acciaio inox AISI 304, brillante o satinato
- Utilizza sacchetti in carta (14x28 cm - cod. 99096)
- Viteria inox inclusa

### Paper sanitary towel bag dispenser

- AISI 304 s. steel, with polished or brushed finish
- For paper sanitary bags (14x28 cm - cod. 99096)
- Stainless steel fixing hardware included

Inox AISI 304 brillante  
AISI 304 polished s.steel

105053

Inox AISI 304 satinato  
AISI 304 brushed s.steel

105055

## BRINOX



316 mm  
47 mm  
215 mm

### Distributore di carta copriwater

- Acciaio inox AISI 304, brillante o satinato
- Serratura antivandalo in metallo
- Utilizza carta copri water (cod. 109114 -109118)
- Viteria inox inclusa

### Toilet seat cover dispenser

- AISI 304 stainless steel, with polished or brushed finish
- Vandal-proof stainless steel keyed lock
- For paper toilet seat covers (cod. 109114 -109118)
- Stainless steel fixing hardware included



Inox AISI 304 brillante  
AISI 304 polished s.steel

105050

Inox AISI 304 satinato  
AISI 304 brushed s.steel

105052



## BRINOX



126 mm  
126 mm  
126 mm

### Portafazzoletti quadrato

- Acciaio inox AISI 304, brillante o satinato
- Dim. max scatola (LxPxH): 12x12x12 cm
- D'appoggio o murale
- Viteria inox inclusa

### Square tissue holder

- AISI 304 s.steel, with polished or brushed finish
- Max box. dim (LxDxH): 12x12x12 cm
- Freestanding or wall mounted installation
- S.steel fixing hardware included

Portafazzoletti inox AISI 304 brillante  
*AISI 304 polished s.steel tissue holder*

105057

Portafazzoletti inox AISI 304 satinato  
*AISI 304 brushed s.steel tissue holder*

105058

## BRINOX



75 mm  
137 mm  
260 mm

### Portafazzoletti e/o porta guanti

- Acciaio inox AISI 430, brillante o satinato
- Dim. max scatola (LxPxH): 25x13x7 cm
- D'appoggio o murale
- Gommini di protezione sulla base
- Viteria inox inclusa

### Tissue and/or gloves holder

- S.steel AISI 430, with polished or brushed finish
- Max box. dim (LxDxH): 25x13x7 cm
- Wall mounted fastening or freestanding
- Rubber protection on the base
- Fixing hardware included

Portafazzoletti inox AISI 430 brillante  
*AISI 430 polished s.steel tissue holder*

105051

Portafazzoletti inox AISI 430 satinato  
*AISI 430 brushed s.steel tissue holder*

105056

Portafazzoletti/guanti inox AISI 430 brillante  
*AISI 430 polished s.steel tissue/glove holder*

105054

## BRINOX



350 mm  
73 mm  
245 mm

### Distributore triplo di guanti monouso

- Acciaio inox AISI 304 brillante
- Contiene fino a 3 scatole di guanti
- Dim. max scatola (LxPxH): 24x6,5x11 cm
- Consente di disporre ordinatamente guanti di diverse taglie
- Fissaggio murale (viteria non inclusa)

### Triple dispenser of disposable gloves

- AISI 304 stainless steel, with polished finish
- Holds up to 3 glove boxes
- Max. box. dim. (LxDxH): 24x6,5x11 cm
- Allow easy access to many sizes of gloves
- Wall mounted fastening (fixing hardware not included)



Portaguanti triplo  
*Triple dispenser*

773021



## BRINOX

25  
L



640 mm  
163 mm  
355 mm

### Gettacarte con coperchio push

- Acciaio inox AISI 304 brillante o AISI 201 satinato
- Apertura del coperchio "push"
- Reggisacco interno
- Fissaggio murale o d'appoggio
- Viteria inox inclusa

### Push opening waste bin

- AISI 304 polished s.steel or AISI 201 brushed s.steel
- Push door access to bin
- Inner sack holder
- Wall mounted fastening or freestanding
- Stainless steel fixing hardware included

Inox AISI 304 brillante  
*AISI 304 polished s.steel*

110520

Inox AISI 201 satinato  
*AISI 201 brushed s.steel*

110521

## STORICO

50  
L



940 mm  
240 mm  
325 mm

### Gettacarte basculante

- Corpo e coperchio in inox brillante
- Apertura con sportello basculante
- D'appoggio

### Swing waste bins

- Polished s.steel
- Swinging opening
- Floorstanding



Inox brillante 50 L  
*Polished s.steel 50 L*

790563

50  
L



940 mm  
240 mm  
325 mm

### Gettacarte push

- Corpo e coperchio in inox brillante
- Sportello push in inox brillante
- Possibilità di fissaggio murale
- Viteria non inclusa

### Push waste bins

- Polished s.steel
- Push opening trap
- Suitable for wall mounting
- Fixing hardware not included



Inox brillante 50 L  
*Polished s.steel 50 L*

790557





## BOB

25  
L

30  
L



500 mm  
200 mm  
300 mm



Secchio interno  
Inner bucket

### Gettacarte

- Acciaio inox, brillante o satinato
- Secchio interno in acciaio zincato con maniglia
- Fissaggio murale o d'appoggio
- Viteria non inclusa

### Waste bin

- Stainless steel, with polished or brushed finish
- Galvanized inner bucket with handle
- Freestanding or wall mounted fastening
- Fixing hardware not included



Inox brillante 25 L  
Polished s.steel 25 L

773001

Inox satinato 25 L  
Brushed s.steel 25 L

773006

## BOB BASIC

25  
L

30  
L



500 mm  
200 mm  
300 mm

### Gettacarte

- Acciaio inox brillante o satinato
- Fissaggio murale o d'appoggio
- Viteria non inclusa

### Waste bin

- Stainless steel, with polished or brushed finish
- Freestanding or wall mounted fastening
- Fixing hardware not included



Inox brillante 25 L  
Polished s.steel 25 L

773002

Inox satinato 25 L  
Brushed s.steel 25 L

773007



## BRINOX

30  
L



400 mm  
405 mm  
193 mm



Apertura  
Opening

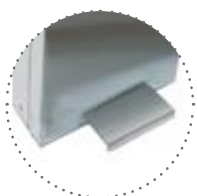

Pedale  
Pedal

### Contenitore di sacchetti igienici

- Acciaio inox AISI 304 satinato
- Apertura a "bocca di lupo" con pedale
- Specifico per raccogliere sacchetti igienici
- Coperchio dotato di chiusura silenziosa
- Serratura con chiave in metallo

### Sanitary towel disposal bin

- AISI 304 brushed stainless steel
- Front opening with pedal
- Ideal to collect sanitary towels
- Lid includes a soft-close system
- Stainless steel keyed lock



Inox AISI 304 satinato 30 L  
AISI 304 brushed s.steel 30 L

789080

## BRINOX

10  
L



300 mm  
130 mm  
250 mm

### Pattumiera murale

- Acciaio inox AISI 304, con finitura brillante o satinata
- Anello interno reggisacco
- Viteria inclusa

### Wall-mounted waste bin

- AISI 304 stainless steel, with polished or brush finish
- Inner bag holder
- Stainless steel fixing hardware included

Inox AISI 304 brillante  
AISI 304 polished s.steel

105062

Inox AISI 304 satinato  
AISI 304 brushed s.steel

105063

## BIN PLUS

5  
L



278 mm  
265 mm  
205 mm

### Pattumiera a pedale

- Acciaio inox, brillante o satinato
- Maniglia di trasporto posteriore
- Coperchio con chiusura silenziosa
- Sistema di bloccaggio del coperchio per ricambio sacco
- Secchio interno, pedale e base in plastica

### Pedal bin

- Stainless steel, polished or brushed finish
- Back handle for easy moving
- Silent closing lid
- Lid may be blocked to facilitate bag replacement
- Plastic inner bucket, pedal and non-scratch base

Inox brillante  
Polished s.steel

112055

Inox satinato  
Brushed s.steel

112059

## LINEA PURA

### PURA RANGE



Distributori carta asciugamani  
Paper towel dispenser



Distributori sapone liquido  
Liquid soap dispensers



Distributori carta  
igienica in rotolo  
Toilet roll dispensers



Distributori carta  
igienica interfogliata  
Interfold toilet  
tissue dispensers



Portascopini  
Toilet brush holders



Pattumiera murale  
Waste bin



Gettacarte murale  
Wall mount waste bin



## PURA

400  
F



350 mm  
102 mm  
280 mm



### Distributore di carta asciugamani (400 fogli)

- Metallo verniciato bianco con polvere epossidica
- Per carta asciugamani piegata a C o Z
- Capienza fino a 400 fogli
- Finestra per il controllo del livello della carta
- Serratura antivandalo in metallo
- Viteria inox inclusa

### Hand towel dispenser (400 sheets)

- White powder epoxy coated steel
- Holds C or Z-fold paper towel
- Capacity up to 400 sheets
- Front viewing window to monitor paper level
- Vandal-proof stainless steel keyed lock
- Stainless steel fixing hardware included



Distributore carta asciugamani metallo bianco 400 F  
Hand towel dispenser white steel 400 S

105018

## PURA

1,2  
L

1,8 ml



320 mm  
110 mm  
100 mm

### Distributore di sapone liquido

- Metallo verniciato bianco con polvere epossidica
- Tanica in plastica a riempimento da 1,2 L
- Per tutti i tipi di sapone, salvo a microgranuli
- Sistema di erogazione "pull"
- Finestra per il controllo del livello del sapone
- Serratura antivandalo in metallo
- Viteria inox inclusa

### Liquid soap dispenser

- White powder epoxy coated steel
- Refillable plastic tank 1,2 L
- For all kind of liquid soaps, except for microbead soaps
- Pull anti-drip pump
- Front viewing window to monitor soap level
- Vandal-proof stainless steel keyed lock
- Stainless steel fixing hardware included



Distributore di sapone liquido metallo bianco 1,2 L  
Liquid soap dispenser white steel 1,2 L

105035



## PURA

400  
M



320 mm  
130 mm  
310 mm

### Distributore di carta igienica in rotolo (400 m)

- Metallo verniciato bianco con polvere epossidica
- Per rotoli fino a 400 mt (max. Ø rotolo 300 mm)
- Mandrino rettangolare in metallo per limitare il consumo della carta
- Diagonale del mandrino: 55 mm
- Lame su tre lati per facilitare il taglio della carta
- Finestra per il controllo del livello della carta
- Serratura antivandalo in metallo
- Viteria inox inclusa

### Maxi jumbo toilet roll dispenser (400 m)

- White powder epoxy coated steel
- Holds up to 400 m toilet paper roll (max. Ø 300 mm)
- Rectangular spindle designed to minimize paper wastage
- Spindle diagonal: 55 mm
- Three blades for easy paper cut
- Front viewing window to monitor paper level
- Vandal-proof stainless steel keyed lock
- Stainless steel fixing hardware included



Mandrino  
Spindle



Tre lame tagliacarta  
Three blades



Vers. "Essential"  
"Essential" version

Distrib. carta igienica rotolo bianco 400 M  
Maxi jumbo toilet paper white steel 400 M

105008

Distrib. carta igienica rotolo bianco 400 M (Essential)  
Maxi jumbo toilet paper white 400 M (Essential)

105608

## PURA

500  
F

Doppio  
Double



270 mm  
120 mm  
133 mm

250  
F

Singolo  
Single



150 mm  
120 mm  
133 mm

### Distributore di carta igienica interfogliata

- Metallo verniciato bianco con polvere epossidica
- Per carta igienica interfogliata
- Capienza: 250 fogli (singolo) o 500 fogli (doppio)
- Finestra per il controllo del livello della carta
- Serratura antivandalo in metallo
- Viteria inox inclusa

### Interfold toilet tissue dispenser

- White powder epoxy coated steel
- Holds interfold toilet tissues
- Capacity: 250 (single) or 500 (double) sheets
- Front viewing window to monitor paper level
- Vandal-proof stainless steel keyed lock
- Stainless steel fixing hardware included



Distrib. carta igienica interfogliata metallo bianco  
Interfold toilet tissue dispenser white steel

250 F

105022

500 F

105027





## PURA



380 mm  
98 mm

### Portascopino

- Metallo verniciato bianco
- Bacinella di recupero dei liquidi in plastica

### Toilet brush holder

- White coated steel
- Inner plastic tank for liquid collection



Portascopino appoggio metallo bianco  
Toilet brush holder white steel

101801

## PURA

10  
L

20  
L



300 mm  
130 mm  
250 mm

### Pattumiera murale

- Metallo verniciato bianco con polvere epossidica
- Anello interno reggisacco
- Viteria inox inclusa

### Wall-mounted waste bin

- White powder epoxy coated steel
- Inner bag holder
- Stainless steel fixing hardware included

Pattumiera murale metallo bianco 10 L  
Wall mounted waste bin white steel 10 L

105061

## MILUNA PURA

40  
L

60  
L

20  
L

30  
L



647 mm  
195 mm  
395 mm



388 mm  
195 mm  
395 mm

### Gettacarte murale

- Metallo verniciato bianco
- Elastico fermasacco
- Fissaggio murale
- Viteria non inclusa

### Wall mount waste bin

- White coated steel
- Bag held in place by elastic band
- Wall mounted fastening
- Fixing hardware not included



Gettacarte murale metallo bianco 20 L  
Wall mounted waste bin white steel 20 L

773033

Gettacarte murale metallo bianco 40 L  
Wall mounted waste bin white steel 40 L

773043

## LINEA NOIR

### NOIR RANGE



Distributori carta asciugamani  
Paper towel dispensers



Distributori sapone liquido  
Liquid soap dispensers



Distributori sapone a schiuma  
Foam soap dispensers



Distributori carta igienica in rotolo  
Mini jumbo toilet roll  
dispensers



Distributori carta igienica  
interfogliata o rotolo  
Interfold toilet  
tissue/roll dispensers



Portascopini  
Toilet brush holders



Porta fazzoletti rettangolare  
Rectangular tissues dispenser



Porta fazzoletti quadrato  
Square tissues dispenser



Distributori per sacchetti  
igienici in plastica  
Plastic sanitary towel  
bag dispensers



Distributori per sacchetti  
igienici in carta  
Paper sanitary towel  
bag dispensers



Distributori di carta copriwater  
Toilet seat cover dispensers



Gettacarte  
Waste bins



## NOIR

400  
F



340 mm  
92 mm  
250 mm

### Distributore di carta asciugamani (400 fogli)

- Base in ABS argento e cover in ABS nero
- Per carta asciugamani piegata a C, Z o M
- Capienza fino a 400 fogli
- Finestra per il controllo del livello della carta
- Chiusura con chiave in plastica
- Design moderno ed elegante
- Viteria inclusa

### Hand towel dispenser (400 sheets)

- Silver ABS backing and black ABS cover
- Holds C, Z or M-fold paper towel
- Capacity up to 400 sheets
- Front viewing window to monitor paper level
- Plastic keyed lock
- Sleek and contemporary design
- Fixing hardware included



Distrib. carta asciugamani ABS nero 400 fogli  
Hand towel dispenser black ABS 400 sheets

104220

## NOIR

500  
F



380 mm  
128 mm  
278 mm

### Distributore di carta asciugamani (500 fogli)

- Base in ABS argento e cover in ABS nero
- Per carta asciugamani piegata a C, Z, M o V
- Capienza fino a 500 fogli
- Finestra per il controllo del livello della carta
- Chiusura con chiave in plastica
- Design moderno ed elegante
- Viteria inclusa

### Hand towel dispenser (500 sheets)

- Silver ABS backing and black ABS cover
- Holds C, Z, M or V-fold paper towel
- Capacity up to 500 sheets
- Front viewing window to monitor paper level
- Plastic keyed lock
- Sleek and contemporary design
- Fixing hardware included



DISPONIBILE IN AR SU MEDIAL APP  
AVAILABLE IN AR ON MEDIAL APP



Distrib. carta asciugamani ABS nero 500 fogli  
Hand towel dispenser black ABS 500 sheets

104226



## NOIR

1 L

Sistema "push"  
Push-operated



275 mm  
105 mm  
110 mm



Sistema puh  
Push-operated

0,5 L

Sistema "push"  
Push-operated



209 mm  
93 mm  
101 mm



Finestra di controllo  
Viewing window

### Distributore di sapone liquido

- Base in ABS argento e cover in ABS nero
- Tanica in plastica a riempimento da 0,5 L o 1 L
- Per tutti i tipi di sapone, salvo a microgranuli
- Sistema di erogazione "push" anti-gocciolamento
- Finestra per il controllo del livello del sapone
- Apertura cover con pulsante in plastica
- Viteria inclusa

### Liquid soap dispenser

- Silver ABS backing and black ABS cover
- Refillable plastic tank 0,5 L or 1 L
- For all kind of liquid soaps, except for microbead soaps
- Push-operated anti-drip pump
- Front viewing window to monitor soap level
- Cover opening with push button
- Fixing hardware included



DISPONIBILE IN AR SU MEDIAL APP  
AVAILABLE IN AR ON MEDIAL APP



Distributore sapone liquido ABS nero 0,5 L  
Liquid soap dispenser black ABS 0,5 L

104240

Distributore sapone liquido ABS nero 1 L  
Liquid soap dispenser black ABS 1 L

104241

## NOIR

0,75 L

Sistema "push"  
Push-operated



210 mm  
98 mm  
114 mm



Sistema puh  
Push-operated



Finestra di controllo  
Viewing window

### Distributore di sapone a schiuma

- Base in ABS argento e cover in ABS nero
- Tanica in plastica a riempimento da 0,75 L
- Per saponi a schiuma
- Sistema di erogazione "push" anti-gocciolamento
- Finestra per il controllo del livello del sapone
- Apertura cover con pulsante in plastica
- Viteria inclusa

### Foam soap dispenser

- Backing and cover from silver coated ABS
- Refillable plastic tank 0,75 L
- For foam soaps
- Push-operated anti-drip pump
- Front viewing window to monitor soap level
- Cover opening with push button
- Fixing hardware included



Distributore sapone a schiuma ABS nero 0,75 L  
Foam soap dispenser black ABS 0,75 L

104245



## NOIR

200  
M

MINI  
JUMBO



294 mm  
120 mm  
282 mm

400  
M

MAXI  
JUMBO



355 mm  
137 mm  
347 mm

### Distributore di carta igienica in rotolo

- Base in ABS argento e cover in ABS nero
- Mini jumbo: mandrino Ø 45 mm (max Ø rotolo 255 mm)
- Maxi jumbo: mandrino Ø 45 e 70 mm (max Ø rotolo 300 mm)
- Serratura in plastica
- Viteria inclusa

### Toilet paper roll dispenser

- Silver ABS backing and black ABS cover
- Mini jumbo: spindle Ø 45 mm for 200 mt paper roll (max. dim. Ø 255 mm)
- Maxi jumbo: spindle Ø 45 and 70 mm for 400 mt paper roll (max. dim. Ø 300 mm)
- Front viewing window to monitor paper level
- Fixing hardware included



DISPONIBILE IN AR SU MEDIAL APP  
AVAILABLE IN AR ON MEDIAL APP



Distrib. carta igienica rotolo ABS nero 200 M  
Mini jumbo toilet paper disp. black ABS 200 M

104201

Distrib. carta igienica rotolo ABS nero 400 M  
Maxi jumbo toilet paper disp. black ABS 400 M

104205

## NOIR

500  
F

2 rotoli standard  
2 standard rolls



296 mm  
139 mm  
148 mm

250  
F

1 rotolo standard  
1 standard roll



173 mm  
134 mm  
148 mm

### Distributore carta igienica interfogliata o rotolo

- Base in ABS argento e cover in ABS nero
- Capienza 250 fogli (o 1 rotolo standard) o 500 fogli (o 2 rotoli standard)
- Può ospitare anche rotoli di carta igienica standard
- Viteria inclusa

### Interfold or roll toilet tissue dispenser

- Silver ABS backing and black ABS cover
- Holds 250 sheets (or 1 stand. roll) or 500 interfolded sheets (or 2 stand. rolls)
- It can also hold household rolls
- Fixing hardware included



DISPONIBILE IN AR SU MEDIAL APP  
AVAILABLE IN AR ON MEDIAL APP



Distrib. carta interfogliata ABS nero 500 F o 2 rotoli  
Interfold toilet tissue dispenser black ABS 500 S or 2 rolls

104256

Distrib. carta interfogliata ABS nero 250 F o 1 rotolo  
Interfold toilet tissue dispenser black ABS 250 S or 1 roll

104257





## NOIR



130 mm  
130 mm  
130 mm

### Portafazzoletti quadrato

- Base e cover in ABS nero
- Per confezioni dim. 11,5x11,5x12 cm
- D'appoggio o murale
- Viteria inclusa

### Square tissues dispenser

- Black ABS backing and cover
- Holds box dim. 11,5x11,5x12 cm
- Freestanding or wall mounted installation
- Fixing hardware included

Portafazzoletti quadrato ABS nero  
Square tissue holder black ABS

130020

## NOIR



60 mm  
140 mm  
257 mm

### Portafazzoletti rettangolare

- Base e cover in ABS nero
- Per confezioni dim. 24,5x13,5x5,5 cm
- D'appoggio o murale
- Viteria inox inclusa

### Rectangular tissue dispenser

- Black ABS backing and cover
- Holds box dim. 24,5x13,5x5,5 cm
- Wall mounted fastening or freestanding
- Fixing hardware included

Portafazzoletti rettangolare ABS nero  
Rectangular tissue holder black ABS

130005

## NOIR

Versione da appoggio  
Freestanding version

Versione murale  
Wall-mounted version



400 mm  
103 mm



400 mm  
115 mm  
103 mm

### Portascopino

- Manico in ABS argento e corpo in ABS nero
- Da pavimento o murale
- Viteria inclusa

### Toilet brush holder

- Silver ABS handle and black ABS base
- Freestanding or wall mounted
- Fixing kit included

Portascopino d'appoggio ABS nero  
Freestanding toilet brush holder black ABS

104280

Portascopino murale ABS nero  
Wall mounted toilet brush holder black ABS

104282



## NOIR



137 mm  
25 mm  
98 mm

### Distributori di sacchetti igienici in plastica

- Base e cover in ABS nero
- Per sacchetti in plastica dim. (LxPxH): 8,7x2x12,4 cm
- Utilizza sacchetti in HDPE (cod. 799002)
- D'appoggio o murale (viteria inclusa)

### Plastic sanitary disposal bag dispenser

- Black ABS backing and cover
- For HDPE sanitary bags dim. (LxDxH): 8,7x2x12,4 cm
- Suitable for refills ref. 799002
- Wall mounted or freestanding (fixing hardware included)

Distrib. sacchetti igienici in plastica ABS nero  
*Plastic sanitary disposal bags disp. black ABS*

130004

## NOIR



290 mm  
54 mm  
140 mm

### Distributori di sacchetti igienici in carta

- Base e cover in ABS nero
- Utilizza sacchetti in carta dim. (LxH): 12x28 cm (cod. 99096)
- Viteria inclusa

### Paper sanitary disposal bag dispenser

- Black ABS backing and cover
- For paper sanitary bags dim. (LxH): 12x28 cm (cod. 99096)
- Fixing hardware included

Distributore sacchetti igienici in carta ABS nero  
*Paper sanitary disposal bag disp. silver ABS*

130017

## NOIR



290 mm  
57 mm  
235 mm

### Distributore di carta copriwater

- Base e cover in ABS nero
- Dim. max scatola (LxPxH): 19,5x4x25 cm
- Utilizza carta copriwater cod. 109114 o 109118
- Viteria inclusa

### Toilet seat cover dispenser

- Black ABS backing and cover
- Suitable for toilet seat cover ref. 109114 or 109118
- Max box. dim (LxDxH): 19,5x4x25 cm
- Fixing hardware included



Distributore carta copriwater ABS nero  
*Toilet seat cover dispenser black ABS*

130014



## MILUNA NOIR



647 mm  
195 mm  
395 mm

388 mm  
195 mm  
395 mm

### Gettacarte murale

- Metallo verniciato nero
- Elastico fermasacco
- Fissaggio murale
- Viteria non inclusa

### Wall mount waste bin

- Black coated steel
- Bag held in place by elastic band
- Wall mounted fastening
- Fixing hardware not included



Gettacarte murale metallo nero 20 L Wall mount paper bin black steel 20 L	773031
Gettacarte murale metallo nero 40 L Wall mounted paper bin black steel 40 L	773041

## NOIR SLOT



750 mm  
270 mm  
390 mm

### Gettacarte con coperchio ad imbocco

- Corpo e coperchio in polipropilene
- Speciale apertura che nasconde il contenuto
- Reggisacco incluso
- D'appoggio o murale (kit incluso)

### Waste bin with slot lid

- Body and lid made of polypropylene
- Special lid shape keeps the wastes out of sight
- Sack holder included
- Freestanding or wall mounted (kit included)

Gettacarte nero con coperchio ad imbocco 50 L Black waste bin with slot lid 50 L	907501
---	--------

## NOIR



480 mm  
428 mm  
174 mm

### Contenitore per sacchetti igienici

- Struttura e coperchio in ABS nero
- Apertura a "bocca di lupo" con pedale
- Coperchio bloccasacco
- Sacchetti antimicrobici in opzione (cod. 130202)

### Sanitary towel disposal bin

- Body and lid made of black ABS
- Front opening with pedal
- Lid can be used as bag holder
- Holds antimicrobial bags (code 130202)

Contenitore ABS nero 15 L Black ABS sanitary bin 15 L	104281
--	--------



## NEW BIN BASIC



5 L



265 mm  
223 mm



### Pattumiera a pedale

- Acciaio zincato verniciato a polvere nera
- Maniglia di trasporto in plastica
- Secchio interno in polipropilene
- Pedale e base in plastica

### Pedal bin

- Black coated steel
- Metal back handle
- Plastic inner bucket
- Plastic pedal and base



Pattumiera a pedale acciaio verniciato nero  
Pedal bin black coated s.steel

913052

## ESA



5 L



240 mm  
210 mm  
200 mm



### Pattumiera a pedale

- Polipropilene
- Sistema di apertura del coperchio in plastica
- Secchio interno in plastica con maniglia
- Stabili e di facile manutenzione

### Pedal bin

- Polypropylene
- Plastic opening mechanism
- Plastic inner bucket with handle
- Easy to clean and handle



Pattumiera a pedale nera (imballo multiplo)  
Black pedal bin (sold in packs of multiple items)

909106

## RIF BASIC

35 L



500 mm  
290 mm  
360 mm



Supporto murale  
Wall bracket

### Pattumiera con coperchio basculante

- Polipropilene nero
- Coperchio basculante utile come fermasacco
- Supporto murale in opzione

### Swing paper bin

- Black polypropylene
- Swing lid
- Wall mounting kit sold separately

Pattumiera nera con basculante 35 L  
Black bin with swing lid 35 L

909536

Supporto murale  
Wall bracket

779906

## SLIM

10 L



340 mm  
265 mm  
270 mm



### Pattumiera a pedale

- Polipropilene nero
- Sistema di apertura del coperchio in metallo
- Reggisacco interno in plastica
- Stabile e di facile manutenzione

### Pedal waste bin

- Polypropylene
- Plastic opening mechanism
- Plastic inner sack holder
- Easy to clean and handle

Pattumiera a pedale nera (imballo singolo)  
Black pedal bin (sold per unit)

909811

Pattumiera a pedale nera (imballo multiplo)  
Black pedal bin (sold per box)

909810

## LINEA BASICA

### BASICA RANGE



Distributori carta asciugamani  
Paper towel dispensers



Distributori sapone liquido  
Liquid soap dispensers



Distributori sapone a schiuma  
Foam soap dispensers



Distributori automatici di sapone  
liquido o gel igienizzante  
Automatic soap or  
hand gel dispensers



Distributori automatici di  
sapone a schiuma  
Automatic foam soap  
dispensers



Distributori automatici  
liquido igienizzante  
Liquid hand sanitizer  
automatic dispensers



Distributori carta  
igienica in rotolo  
Toilet roll dispensers



Distributori carta igienica  
interfogliata o rotolo  
Interfold toilet  
tissue/roll dispensers



Portarotoli  
Toilet paper holders



Portascopini  
Toilet brush holders



Distributori per  
sacchetti igienici  
Plastic sanitary towel  
bag dispensers



Distributori carta copriwater  
Toilet seat cover dispensers



Portafazzoletti  
Tissue holder



Gettacarte  
Paper bins



Sacchetti igienici  
Sanitary bags





## BASICA

200  
F



220 mm  
92 mm  
250 mm

400  
F



340 mm  
92 mm  
250 mm

### Distributore di carta asciugamani (200/400 fogli)

- Base in ABS grigio e cover in ABS bianco
- Per carta asciugamani piegata a C, Z o M
- Capienza fino a 200 o 400 fogli
- Finestra per il controllo del livello della carta
- Serratura in plastica
- Design moderno ed elegante
- Viteria inclusa

### Hand towel dispensers (200/400 sheets)

- Grey ABS backing and white ABS cover
- Holds C, Z or M-fold paper towel
- Capacity up to 200 or 400 sheets
- Front viewing window to monitor paper level
- Plastic keyed lock
- Sleek and contemporary design
- Fixing hardware included



Distrib. carta asciugamani ABS bianco 200 fogli  
*Hand towel dispenser white ABS 200 sheets*

104022

Distrib. carta asciugamani ABS bianco 400 fogli  
*Hand towel dispenser white ABS 400 sheets*

104020

## BASICA

500  
F



380 mm  
128 mm  
278 mm



Punto d'estrazione  
*Release of paper*

### Distributore di carta asciugamani (500 fogli)

- Base in ABS grigio e cover in ABS bianco
- Per carta asciugamani piegata a C, Z, M o V
- Capienza fino a 500 fogli
- Finestra per il controllo del livello della carta
- Serratura in plastica
- Design moderno ed elegante
- Viteria inclusa

### Hand towel dispenser (500 sheets)

- Grey ABS backing and white ABS cover
- Holds C, Z, M or V-fold paper towel
- Capacity up to 500 sheets
- Front viewing window to monitor paper level
- Plastic keyed lock
- Sleek and contemporary design
- Fixing hardware included



Distrib. carta asciugamani ABS bianco 500 fogli  
*Hand towel dispenser white ABS 500 sheets*

104026



## BASICA

1 L

1 ml

Sistema "push"  
Push-operated



275 mm  
105 mm  
110 mm

0,5 L

1 ml

Sistema "push"  
Push-operated



209 mm  
93 mm  
101 mm

0,5 L

1 ml

Sistema "a gomito"  
Elbow-operated



209 mm  
110 mm  
101 mm



### Distributore di sapone liquido

- Base in ABS grigio e cover in ABS bianco
- Tanica in plastica a riempimento da 0,5 L o 1 L
- Per tutti i tipi di sapone, salvo a microgranuli
- Sistema di erogazione a gomito o "push" anti-gocciolamento
- Finestra per il controllo del livello del sapone
- Apertura cover con pulsante in plastica
- Viteria inclusa

### Liquid soap dispenser

- Grey ABS backing and white ABS cover
- Refillable plastic tank 0,5 L or 1 L
- For all kind of liquid soaps, except for microbead soaps
- Elbow or push-operated anti-drip pump
- Front viewing window to monitor soap level
- Cover opening with push button
- Fixing hardware included

Distributore sapone push ABS bianco 0,5 L <i>Liquid soap dispenser white ABS 0,5 L</i>	104040
Distributore sapone push ABS bianco 1 L <i>Liquid soap dispenser white ABS 1 L</i>	104041
Distributore sapone a gomito ABS bianco 0,5 L <i>Elbow-oper. liquid soap dispenser white ABS 0,5 L</i>	104046

## BASICA MOUSSE & EKKO

0,75 L

0,5 ml

Basica  
Mousse



210 mm  
98 mm  
114 mm

0,5 L

0,5 ml

Ekko



230 mm  
130 mm  
70 mm

### Distributore di sapone a schiuma

- Base in ABS grigio e cover in ABS bianco
- Tanica in plastica a riempimento da 0,5 L e 0,75 L
- Per saponi a schiuma
- Sistema di erogazione "push"
- Finestra per il controllo del livello del sapone
- Serratura con chiave in plastica (cod. 104045)
- Sistema chiusura a scatto con apertura a pulsante (cod. 104044)
- Viteria inclusa

### Foam soap dispenser

- Backing and cover from silver coated ABS
- Refillable plastic tank 0,5 and 0,75 L
- For foam soaps
- Push-operated anti-drip pump
- Front viewing window to monitor soap level
- Plastic key locked system on cod. 104045
- Cover opening with push button on cod. 104044
- Fixing hardware included



Distrib. sapone schiuma Ekko 0,5 L <i>Foam soap dispenser Ekko 0,5 L</i>	104044
Distrib. sapone schiuma Basica Mousse 0,75 L <i>Foam soap dispenser Basica Mousse 0,75 L</i>	104045

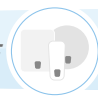

## BASICA MATIC

1 L



250 mm  
100 mm  
140 mm

0,5 L



205 mm  
95 mm  
95 mm

1 L



250 mm  
100 mm  
140 mm

### Distributore automatico di sapone liquido / gel igienizzante

- Base in ABS grigio e cover in ABS bianco
- Tanica in plastica a riempimento da 0,5 L o 1 L
- Per tutti i tipi di sapone (no microgranuli) o gel igienizzante
- Sistema di erogazione automatica con sensore a infrarossi
- Alimentazione: 4 pile da 1,5 V alcaline AA (non comprese)
- Alimentatore di corrente solo per versione da 1 L (in opzione)
- **Installazione a minimo 30 cm dal lavabo**
- Chiusura con chiave in plastica
- Viteria inclusa

### Automatic dispenser for liquid soap / hand gel sanitizer

- Grey ABS backing and white ABS cover
- Refillable plastic tank 0,5 L or 1 L
- For liquid soap (no microbeads) or hand sanitizer gel
- Infrared sensor operated
- Battery powered - 4x1,5 V alkaline AA (not included)
- AC adapter for 1 L dispenser only (not included)
- **Installation at least 30 cm from the sink**
- Plastic keyed lock
- Fixing hardware included



Dist. automatico sapone liquido/gel igieniz. ABS bianco 1 L <i>Automatic liquid soap / hand gel disp. white ABS 1 L</i>	<b>104050</b>
Dist. automatico sapone liquido/gel igieniz. ABS bianco 0,5 L <i>Automatic liquid soap / hand gel disp. white ABS 0,5 L</i>	<b>104055</b>
Alimentatore di corrente per dispenser automatici BASICA 1 L <i>AC adapter for BASICA automatic dispenser 1 L</i>	<b>104951</b>

### Distributore automatico di sapone a schiuma

- Base in ABS grigio e cover in ABS bianco
- Tanica in plastica a riempimento da 1 L
- Per saponi a schiuma
- Sistema di erogazione automatica con sensore a infrarossi
- Alimentazione: 4 pile da 1,5 V alcaline AA (non comprese)
- Alimentatore di corrente in opzione
- **Installazione a minimo 30 cm dal lavabo**
- Chiusura con chiave in plastica
- Viteria inclusa

### Automatic foam soap dispenser

- Grey ABS backing and white ABS cover
- Refillable plastic tank 1 L
- For foam soaps
- Infrared sensor operated
- Operates on four 1,5 V "AA" cell batteries (not included)
- AC adapter 110-240 V / 6 V (not included)
- **Installation at least 30 cm from the sink**
- Plastic keyed lock
- Fixing hardware included



Dist. automatico sapone schiuma ABS bianco 1 L <i>Automatic foam soap white ABS 1 L</i>	<b>104051</b>
Alimentatore di corrente per dispenser automatici BASICA 1 L <i>AC adapter for BASICA automatic dispenser 1 L</i>	<b>104951</b>



## BASICA MATIC

1 L

0,9 ml



250 mm  
100 mm  
140 mm



### Distributore automatico di liquido igienizzante

- Base in ABS grigio e cover in ABS bianco
- Tanica riempimento 1 L per liquidi idroalcolici con antibatterico
- Nebulizzazione automatica con sensore a infrarossi
- Alimentazione a pile o con alimentatore di corrente (non compresi)
- Finestra per il controllo del livello del consumabile
- Chiusura con chiave in plastica e viteria inclusa

### Liquid hand sanitizer automatic dispenser

- Grey ABS backing and white ABS cover
- Refillable tank 1 L for alcohol-based liquid cleaner
- Infrared sensor operated
- Battery powered or AC adapter (not included)
- Front viewing window to monitor liquid level
- Plastic keyed lock and fixing hardware included

Distrib. automatico di liquido igienizzante ABS bianco 1 L  
*Liquid hand sanitizer automatic dispenser white ABS 1 L* **104052**

Alimentatore di corrente per dispenser automatici BASICA 1 L  
*AC adapter for BASICA automatic dispenser 1 L* **104951**

## NEBULA

0,7 L

700 ml



230 mm  
60/100 mm  
230 mm



### Nebulizzatore di liquido igienizzante

- Base e cover in ABS super resistente
- Tanica riempimento 700 ml per liquidi idroalcolici con antibatterico
- Nebulizzazione automatica con sensore a infrarossi
- Possibilità di regolare il tempo e la quantità di liquido erogato
- Alimentatore o pile (4 AA x 1,5 V) non inclusi
- Viteria di fissaggio inclusa

### Alcohol liquid hand rub atomizer

- Heavy-duty ABS backing and cover
- Refillable tank 700 ml for alcohol-based liquid cleaner
- Automatic infrared sensor operated
- Adjustable dispensing time and spray
- AC Adapter or battery powered (4 AA x 1.5 V) not included
- Fixing kit included

Nebulizzatore di liquido igienizzante 0,7 L  
*Alcohol liquid hand rub atomizer 0,7 L* **113000**

Alimentatore di corrente per dispenser automatici NEBULA  
*AC adapter for NEBULA automatic dispenser* **104950**

## BASICA SPRAY

0,5 L

0,9 ml



198 mm  
115 mm  
99 mm



Sistema "push"  
*Push-operated*

### Distributore di liquido igienizzante

- Base in ABS grigio e cover in ABS bianco
- Tanica in plastica a riempimento da 0,5 L
- Per soluzioni idroalcoliche con antibatterico
- Sistema di nebulizzazione "push"
- Chiusura con chiave in plastica
- Viteria inclusa

### Liquid hand sanitizer dispenser

- Grey ABS backing and white ABS cover
- Refillable plastic tank 0,5 L
- For alcohol-based liquid cleaner
- Push-atomisation system
- Plastic keyed lock
- Fixing hardware included

Distributore di liquido igienizzante ABS bianco 0,5 L  
*Liquid hand sanitizer dispenser white ABS 0,5 L* **104047**

## BASICA SPRAY SENSOR

0,5 L

0,9 ml



195 mm  
92 mm  
99 mm



### Distributore automatico di liquido igienizzante

- Base e cover in ABS
- Tanica in plastica a riempimento da 0,5 L
- Per soluzioni idroalcoliche con antibatterico
- Sistema di erogazione automatica con sensore a infrarossi
- Alimentazione: 3 pile da 1,5 V alcaline AA (non comprese)
- Chiusura con chiave in plastica e viteria inclusa

### Liquid hand sanitizer automatic dispenser

- Grey ABS backing and white ABS cover
- Refillable plastic tank 0,5 L
- For alcohol-based liquid cleaner
- Infrared sensor operated
- Battery powered 3x1,5 V alkaline AA (not included)
- Plastic keyed lock and fixing hardware included

Distrib. automatico di liquido igienizzante ABS bianco 0,5 L  
*Liquid hand sanitizer automatic dispenser white ABS 0,5 L* **104053**



## BASICA

200  
M MINI  
JUMBO



294 mm  
120 mm  
282 mm

400  
M MAXI  
JUMBO



355 mm  
137 mm  
347 mm

### Distributore carta igienica in rotolo

- Base in ABS grigio e cover in ABS bianco
- Mini jumbo: mandrino Ø 45 mm per rotolo da 200 m (max Ø 255 mm)
- Maxi jumbo: mandrino Ø 45 e 70 mm per rotolo da 400 m (max Ø 300 mm)
- Finestra per il controllo del livello della carta
- Serratura in plastica
- Viteria inclusa

### Toilet paper roll dispenser

- Grey ABS backing and white ABS cover
- Mini jumbo: spindle Ø 45 mm for 200 m paper roll (max. Ø 255 mm)
- Maxi jumbo: spindle Ø 45 and 70 mm for 400 m paper roll (max. Ø 300 mm)
- Front viewing window to monitor paper level
- Plastic keyed lock
- Fixing hardware included



Distributore carta igienica rotolo ABS bianco 200 M  
*Mini jumbo toilet paper dispenser white ABS 200 M*

104001

Distributore carta igienica rotolo ABS bianco 400 M  
*Maxi jumbo toilet paper dispenser white ABS 400 M*

104005

500  
F 2 rotoli standard  
2 standard rolls



296 mm  
139 mm  
148 mm

250  
F 1 rotolo standard  
1 standard roll



173 mm  
134 mm  
148 mm

### Distributore carta igienica interfogliata o in rotolo

- Base in ABS grigio e cover in ABS bianco
- Per carta igienica interfogliata o rotoli carta igienica
- Capienza 250 fogli (1 rotolo standard) o 500 fogli (2 rotoli standard)
- Può ospitare anche rotoli standard
- Finestra per il controllo del livello della carta
- Serratura in plastica
- Viteria inclusa

### Toilet paper roll dispenser

- Grey ABS backing and white ABS cover
- For interfold toilet tissues or standard toilet paper rolls
- Holds 250 sheets (1 stand. roll) or 500 interfolded sheets (or 2 stand. rolls)
- It can also hold household rolls
- Front viewing window to monitor paper level
- Plastic keyed lock
- Fixing hardware included



Distrib. carta interfogliata ABS bianco 500 fogli o 2 rotoli  
*Interfold toilet tissue dispenser white ABS 500 S or 2 rolls*

104056

Distrib. carta interfogliata ABS bianco 250 fogli o 1 rotolo  
*Interfold toilet tissue dispenser white ABS 250 S or 1 roll*

104057



70 mm  
117 mm  
170 mm

### Porta rotolo carta igienica

- ABS bianco
- Utilizza 1 rotolo di tipo standard
- Viteria inclusa

### Toilet tissue roll dispenser

- White ABS
- Suitable for 1 household toilet paper roll
- Fixing hardware included



160 mm  
130 mm  
125 mm

### Porta rotolo chiuso per carta igienica

- Polipropilene bianco
- Utilizza 1 rotolo di tipo standard
- Viteria inclusa

### Toilet paper roll holder with casing

- White polypropylene
- Suitable for 1 household toilet paper roll
- Fixing hardware included

Portarotolo carta igienica standard ABS bianco  
*Toilet paper holder white ABS*

104101

Portarotolo carta igienica carenato polipropilene bianco  
*Toilet paper holder with casing white polypropylene*

710010





## BASICA



130 mm  
130 mm  
130 mm

### Portafazzoletti quadrato

- ABS bianco o cromato
- Per confezioni dim. 11,5x11,5x12 cm
- D'appoggio o murale
- Viteria inclusa

### Square tissues dispenser

- White or chromed ABS
- Holds box dim. 11,5x11,5x12 cm
- Freestanding or wall mounted installation
- Fixing hardware included

Varianti colore / Colors available



Portafazzoletti quadrato ABS bianco <i>Square tissue holder white ABS</i>	130021
Portafazzoletti quadrato ABS cromato <i>Square tissue holder chromed ABS</i>	130022

## BASICA



60 mm  
140 mm  
257 mm

### Portafazzoletti rettangolare

- ABS bianco o cromato
- Per confezioni dim. 24,5x13,5x5,5 cm
- D'appoggio o murale
- Viteria inclusa

### Rectangular tissue holder

- ABS body, with white or chromed finish
- Holds box dim. 24,5x13,5x5,5 cm
- Wall mounted fastening or freestanding
- Fixing hardware included

Varianti colore / Colors available



Portafazzoletti rettangolare ABS bianco <i>Rectangular tissue holder white ABS</i>	130000
Portafazzoletti rettangolare cromato ABS <i>Rectangular tissue holder chromed ABS</i>	130003

## BASICA



290 mm  
57 mm  
235 mm

### Distributore di carta copriwater

- ABS bianco
- Dim. max scatola (LxPxH): 19,5x4x25 cm
- Utilizza carta copriwater cod. 109114 o 109118
- Viteria inclusa

### Toilet seat cover dispenser

- White ABS
- Max box. dim (LxDxH): 19,5x4x25 cm
- Suitable for toilet seat cover ref. 109114 or 109118
- Fixing hardware included



Distributore bianco carta copriwater <i>Whitre toilet seat cover dispenser</i>	130010
---	--------



## BASICA



290 mm  
54 mm  
140 mm

### Distributore di sacchetti igienici in carta

- ABS bianco
- Utilizza sacchetti in carta dim. (LxH): 12x28 cm
- Consigliamo nostra ricarica cod. 99096
- Viteria inclusa

### Paper sanitary towel bag dispensers

- White ABS
- For paper sanitary bags dim. (LxH): 12x28 cm
- Compatible with refill cod. 99096
- Fixing hardware included

Distributore bianco sacchetti igienici in carta  
*White paper sanitary towel bag dispenser*

130015

## BASICA



137 mm  
25 mm  
98 mm

Varianti colore  
*Colors available*



### Distributori di sacchetti igienici in plastica

- ABS bianco o cromato
- Per sacchetti in HDPE dim. (LxPxH): 8,7x2x12,4 cm (cod. 799002)
- D'appoggio o murale
- Viteria inclusa

### Plastic sanitary towel bags dispensers

- White or chromed ABS
- For HDPE sanitary bags dim. (LxDxH): 8,7x2x12,4 cm (cod. 799002)
- Wall mounted fastening or freestanding
- Fixing hardware included

Distrib. sacchetti igienici in plastica ABS bianco  
*Plastic sanitary towel bag dispenser white ABS*

130001

Distrib. sacchetti igienici in plastica ABS cromato  
*Plastic sanitary towel bag dispenser chromed ABS*

130002

## BASICA

Ref. [906450](#)

Ref. [906451](#)



360 mm  
150 mm  
230 mm

360 mm  
125 mm  
150 mm

### Portascopino

- Polipropilene bianco
- Cod. 906450: murale o d'appoggio
- Cod. 906451: solo appoggio

### Toilet brush holder

- White polypropylene
- Cod.906450: freestanding or wall mounted fastening
- Cod. 906451: freestanding only

Portascopino quadrato d'appoggio o murale  
*Freestanding or wall mounted squared toilet brush holder*

906450

Portascopino angolare d'appoggio  
*Freestanding corner toilet brush holder*

906451

## BASICA



400 mm  
103 mm

400 mm  
115 mm  
103 mm

Con supporto murale  
*Wall-mounted bracket*



Varianti colore  
*Colors available*



### Portascopino murale o d'appoggio

- Manico e struttura in ABS bianco o ABS argento; ciuffo in setola bianca
- Murale (Ref. 104102-104482) o d'appoggio (Ref. 104100-104480)
- Viteria inclusa

### Freestanding / Wall-mounted toilet brush holder

- White or Silver ABS handle and structure; white bristle tuft
- Freestanding or (Ref. 104102-104482) wall mounted fastening (Ref. 104100-104480)
- Fixing hardware included

Portascopino d'appoggio ABS bianco  
*Freestanding toilet brush holder white ABS*

104100

Portascopino murale ABS bianco  
*Wall mounted toilet brush holder white ABS*

104102

Portascopino da appoggio ABS argento  
*Freestanding toilet brush holder silver ABS*

104480

Portascopino murale ABS argento  
*Wall-mounted toilet brush holder silver ABS*

104482



## BASICA

15  
L



Varianti colore  
Colors available



480 mm  
428 mm  
174 mm

### Contenitore per sacchetti igienici

- Struttura e coperchio in ABS, bianco o grigio
- Apertura a "bocca di lupo" con pedale
- Coperchio bloccasacco
- Sacchetti antimicrobici in opzione (cod. 130202)

### Sanitary towel disposal bin

- Body and lid from ABS, white or grey
- Front opening with pedal
- Lid can be used as bag holder
- Optional antimicrobial scented liners (cod. 130202)

Contenitore sacchetti igienici grigio 15 L  
Grey sanitary towel disposal bins 15 L

104080

Contenitore sacchetti igienici bianco 15 L  
White sanitary towel disposal bins 15 L

104081

## LADY BIN

17  
L



495 mm  
440 mm  
235 mm

### Contenitore per sacchetti igienici

- Struttura e coperchio in polipropilene
- Apertura a "bocca di lupo" con pedale
- Coperchio bloccasacco con sportello rosso
- Sacchetti antimicrobici in opzione (cod. 130202)

### Sanitary towel disposal bin

- Body and lid from polypropylene
- Special front opening with pedal
- Lid can be used as bag holder
- Optional antimicrobial scented liners (cod. 130202)

Contenitore sacchetti igienici bianco-rosso 17 L  
White-red sanitary towel disposal bins 17 L

705081

## BASICA SLOT

50  
L



740 mm  
270 mm  
380 mm

### Gettacarte con coperchio ad imbocco

- Corpo e coperchio in polipropilene
- Speciale apertura che nasconde il contenuto
- Reggisacco incluso
- D'appoggio o murale (kit incluso)

### Waste bin with slot lid

- Body and lid from polypropylene
- Special lid shape keeps the wastes out of sight
- Sack holder included
- Freestanding or wall-mounted (kit include)

Gettacarte bianco con coperchio ad imbocco 50 L  
White waste bin with slot lid 50 L

907503

## SANILADY

30  
L



560 mm  
1 mm  
590 mm



10 rotoli x 25 sacchetti  
10 rolls x 25 liners

### Sacchetti antimicrobici profumati

- Sacchetti profumati in plastica
- Con tecnologia antimicrobica certificata SGS
- Previene lo sviluppo di agenti patogeni (Stafilococco)
- Dim. sacchetto aperto (LxH): 59x56 cm - Capacità: 30 L ca.
- Conf. 10 rotoli da 25 sacchetti cad.

### Antimicrobial scented bags

- Heavy duty liners, made from plastic
- Incorporates antimicrobial technology, SGS certified
- Protection against harmful germs (Staphylococcus aureus)
- Open bag dim. (LxH): 59x56 cm - Capacity: 30 L
- 10 rolls/pack, each includes 25 scented liners

Sacchetti antimicrobici  
Antimicrobial bags

130202

## LINEA WAVE

### WAVE RANGE



Distributori carta asciugamani  
Interfold paper towel dispenser



Distributore di sapone  
liquido o schiuma  
Liquid or foam  
soap dispenser



Distributori di carta  
igienica in rotolo  
Jumbo toilet  
roll dispensers



Distributori carta  
igienica interfogliata  
Interfold toilet tissue  
dispensers

## LINEA WAVE<sup>2</sup>

### WAVE<sup>2</sup> RANGE



Distributori carta asciugamani  
Interfold paper towel dispenser



Distributore di sapone  
liquido o schiuma  
Liquid or foam  
soap dispenser



Distributori di carta  
igienica in rotolo  
Jumbo toilet  
roll dispensers



Distributori carta  
igienica interfogliata  
Interfold toilet tissue  
dispensers



## WAVE

300  
F

Per carta piegata a C, Z, M e V  
C, Z, M V-fold paper towel

Per carta piegata a C e Z  
C and Z-fold paper towel



280 mm  
130 mm  
270 mm

280 mm  
110 mm  
270 mm

### Distributore carta asciugamani

- Base in ABS grigio e cover in ABS bianco
- Versione per carta asciugamani piegata a C e Z
- Versione per carta asciugamani piegata a C, Z, M, V
- Capienza fino a 300 fogli
- Finestra per il controllo del livello della carta
- Serratura in plastica
- Viteria inclusa

### Hand towel dispenser

- Grey ABS backing and white ABS cover
- Holds C and Z-fold paper towel version
- Holds C, Z, M, V-fold paper towel version
- Capacity up to 300 sheets
- Front viewing window to monitor paper level
- Plastic keyed lock
- Fixing hardware included



Distributore bianco per carta piegata -C, Z da 300 fogli  
C or Z-fold white paper towel dispenser 300 sheets

908020

Distributore bianco carta piegata a C, Z, M e V da 300 fogli  
C, Z, M, V-fold white paper towel dispenser 300 sheets

908021

## WAVE

1 L



220 mm  
125 mm  
155 mm



0,5 L



170 mm  
125 mm  
105 mm



### Distributore di sapone liquido

- Base in ABS grigio e cover in ABS bianco
- Per tutti i tipi di sapone, salvo a microgranuli
- Tanica in plastica a riempimento da 0,5 L o 1 L
- Sistema di erogazione "push" anti-gocciolamento
- Finestra per il controllo del livello del sapone
- Serratura in plastica
- Viteria inclusa

### Liquid soap dispenser

- Grey ABS backing and white ABS cover
- Refillable plastic tank 0,5 L or 1 L
- For all kind of liquid soaps, except for microbeads ones
- Push-operated anti-drip pump
- Front viewing window to monitor soap level
- Plastic keyed lock to discourage theft
- Fixing hardware included



Distributore sapone liquido ABS bianco 0,5 L  
Liquid soap dispenser white ABS 0,5 L

908040

Distributore sapone liquido ABS bianco 1 L  
Liquid soap dispenser white ABS 1 L

908041

## WAVE

1 L



220 mm  
125 mm  
155 mm



### Distributore di sapone a schiuma

- Base in ABS grigio e cover in ABS bianco
- Tanica in plastica a riempimento da 1 L
- Per saponi a schiuma
- Sistema di erogazione "push" anti-gocciolamento
- Finestra per il controllo del livello del sapone
- Serratura in plastica
- Viteria inclusa

### Foam soap dispenser

- Grey ABS backing and white ABS cover
- Refillable plastic tank 1 L
- For foam soap
- Push-operated pump
- Front viewing window to monitor soap level
- Plastic keyed lock to discourage theft
- Fixing hardware included



Distributore sapone a schiuma ABS bianco 1 L  
Foam soap dispenser white ABS 1 L

908045





## WAVE

100  
M



240 mm  
150 mm  
215 mm

### Distributore carta igienica a estrazione centrale

- Base in ABS grigio e cover in ABS bianco
- Per rotolo carta igienica da 100 - 115 M (max Ø 160 mm)
- Serratura in plastica e viteria inclusa

### Central pull-out toilet paper dispenser

- Grey ABS backing and white ABS cover
- For toilet paper roll 100 - 115 M (max. Ø 160 mm)
- Plastic keyed lock and fixing kit included



Distributore carta igienica a estrazione centrale  
Central pull-out toilet paper dispenser

908006

## WAVE

200  
M

MINI  
JUMBO

400  
M

MAXI  
JUMBO



260 mm  
130 mm  
240 mm

330 mm  
130 mm  
310 mm

### Distributori di carta igienica in rotolo

- Base in ABS grigio e cover in ABS bianco
- **MINI JUMBO**: per rotolo carta igienica da 200 M (max Ø 190 mm)
- **MAXI JUMBO**: per rotolo carta igienica da 400 M (max Ø 250 mm)
- Mandrino standard da Ø 40 mm e adattatore Ø 55 mm incluso
- Lame su tre lati per facilitare il taglio della carta
- Finestra per il controllo del livello della carta
- Serratura in plastica e viteria inclusa

### Toilet paper roll dispensers

- Grey ABS backing and white ABS cover
- **MINI JUMBO**: spindle Ø 40 mm for 200 M paper roll (max. Ø 190 mm)
- **MAXI JUMBO**: spindle Ø 40 mm for 400 M paper roll (max. Ø 250 mm)
- Additional ring for spindle, with 55 mm diameter
- Three blades for easy paper cut
- Front viewing window to monitor paper level
- Plastic keyed lock and fixing kit included



Distributore carta igienica in rotolo ABS bianco 200 M  
Maxi Jumbo toilet paper dispenser white ABS 200 M

908001

Distributore carta igienica in rotolo ABS bianco 400 M  
Maxi Jumbo toilet paper dispenser white ABS 400 M

908002

## WAVE

300  
F



225 mm  
120 mm  
135 mm

### Distributore carta igienica interfogliata

- Base in ABS grigio e cover in ABS bianco
- Capienza: 300 fogli
- Finestra per il controllo del livello della carta
- Serratura in plastica
- Viteria inclusa

### Interfold toilet tissue dispenser

- Grey ABS backing and white ABS cover
- Capacity: 300 sheets
- Front viewing window to monitor paper level
- Plastic keyed lock to discourage theft and fixing hardware included



Distrib. carta igienica interfogliata ABS bianco 300 fogli  
Interfold toilet paper disp. white ABS 300 sheets

908025



## WAVE<sup>2</sup>

300  
F

Per carta piegata a C, Z, M e V  
C, Z, M V-fold paper towel

Per carta piegata a C e Z  
C and Z-fold paper towel



280 mm  
130 mm  
270 mm

280 mm  
110 mm  
270 mm

### Distributore carta asciugamani

- Base in ABS grigio e cover in SAN blu trasparente
- Versione per carta asciugamani piegata a C e Z
- Versione per carta asciugamani piegata a C, Z, M, V
- Capienza fino a 300 fogli
- Serratura in plastica
- Viteria inclusa

### Hand towel dispenser

- Grey ABS backing and transparent blue SAN cover
- Holds C and Z-fold paper towel version
- Holds C, Z, M, V-fold paper towel version
- Capacity up to 300 sheets
- Plastic keyed lock
- Fixing hardware included



Distributore carta piegata a C e Z - 300 fogli  
C or Z-fold paper towel dispenser - 300 sheets **908120**

Distributore carta piegata a C, Z, M e V - 300 fogli  
C, Z, M, V-fold paper towel dispenser - 300 sheets **908121**

## WAVE<sup>2</sup>

1 L

1,1 ml

0,5 L

1,1 ml

195 mm  
110 mm  
105 mm



160 mm  
90 mm  
90 mm



### Distributore di sapone liquido

- Base in ABS bianco e cover in SAN blu trasparente
- Per tutti i tipi di sapone, salvo a microgranuli
- Tanica in plastica a riempimento da 0,5 L o 1 L
- Sistema di erogazione "push" anti-gocciolamento
- Finestra per il controllo del livello del sapone
- Serratura in plastica
- Viteria inclusa

### Liquid soap dispenser

- Grey ABS backing and transparent blue SAN cover
- For all kind of liquid soaps, except for microbeads ones
- Refillable plastic tank 0,5 L or 1 L
- Push-operated anti-drip pump
- Front viewing window to monitor soap level
- Plastic keyed lock to discourage theft
- Fixing hardware included



Distributore sapone liquido ABS bianco-SAN trasp. 0,5 L  
Liquid soap dispenser white ABS-transp. SAN 0,5 L **908140**

Distributore sapone liquido ABS bianco-SAN trasp. 1 L  
Liquid soap dispenser white ABS-transp. SAN 1 L **908141**

## WAVE<sup>2</sup>

1 L

0,7 ml

195 mm  
150 mm  
105 mm



### Distributore di sapone a schiuma

- Base in ABS bianco e cover in SAN blu trasparente
- Tanica in plastica a riempimento da 1 L
- Per sapone a schiuma
- Sistema di erogazione "push" anti-gocciolamento
- Finestra per il controllo del livello del sapone
- Serratura in plastica
- Viteria inclusa

### Foam soap dispenser

- Grey ABS backing and transparent blue SAN cover
- Refillable plastic tank 1 L
- For foam soap
- Push-operated pump
- Front viewing window to monitor soap level
- Plastic keyed lock to discourage theft
- Fixing hardware included



Distributore sapone schiuma ABS bianco-SAN trasp. 1 L  
Foam soap dispenser white ABS-transp. SAN 1 L **908145**



## WAVE<sup>2</sup>

200  
M

MINI  
JUMBO



260 mm  
130 mm  
240 mm

### Distributore carta igienica in rotolo

- Base in ABS grigio e cover in SAN blu trasparente
- Per rotolo carta igienica da 200 M (max Ø 190 mm)
- Mandrino standard da Ø 40 mm e adattatore Ø 55 mm incluso
- Lame su tre lati per facilitare il taglio della carta
- Finestra per il controllo del livello della carta
- Serratura in plastica e viteria inclusa

### Toilet paper roll dispenser

- Grey ABS backing and transparent blue SAN cover
- Mini jumbo: spindle Ø 40 mm for 200 M paper roll (max. Ø 190 mm)
- Additional ring for spindle, with 55 mm diameter
- Three blades for easy paper cut
- Front viewing window to monitor paper level
- Plastic keyed lock and fixing kit included



Distributore carta igienica in rotolo 200 M  
Mini jumbo toilet paper dispenser ABS 200 M

908101

## WAVE<sup>2</sup>

400  
M

MAXI  
JUMBO



330 mm  
130 mm  
310 mm

### Distributore carta igienica in rotolo

- Base in ABS grigio e cover in SAN blu trasparente
- Per rotolo carta igienica da 400 M (max Ø 250 mm)
- Mandrino standard da Ø 40 mm e adattatore Ø 55 mm incluso
- Lame su tre lati per facilitare il taglio della carta
- Finestra per il controllo del livello della carta
- Serratura in plastica e viteria inclusa

### Toilet paper roll dispenser

- Grey ABS backing and transparent blue SAN cover
- Maxi jumbo: spindle Ø 40 mm for 400 M paper roll (max. Ø 250 mm)
- Additional ring for spindle, with 55 mm diameter
- Three blades for easy paper cut
- Front viewing window to monitor paper level
- Plastic keyed lock and fixing kit included



Distributore carta igienica in rotolo 400 M  
Maxi jumbo toilet paper dispenser 400 M

908102

## WAVE<sup>2</sup>

300  
F



225 mm  
120 mm  
135 mm

### Distributore carta igienica interfogliata

- Base in ABS grigio e cover in SAN blu trasparente
- Capienza: 300 fogli
- Finestra per il controllo del livello della carta
- Serratura in plastica
- Viteria inclusa

### Interfold toilet tissue dispenser

- Grey ABS backing and white ABS cover
- Capacity: 300 sheets
- Front viewing window to monitor paper level
- Plastic keyed lock to discourage theft and fixing hardware included



Distrib. carta igienica interfogliata 300 fogli  
Interfold toilet paper dispenser 300 sheets

908125

LINEA STILECO

STILECO RANGE



 **STILECO**



La nostra prima gamma ecologica realizzata con plastica riciclata al 100%  
Our first eco-friendly range made from 100% recycled plastic





## STILECO

600  
F



370 mm  
130 mm  
277 mm

### Distributore di carta asciugamani (600 fogli)

- Base e cover in ABS 100% riciclato
- Visore di controllo in policarbonato
- Per carta asciugamani piegata a Z, C, V e M
- Capienza fino a 600 fogli
- Erogazione dal basso, facile e veloce
- Design versatile e innovativo
- Resistente agli urti e agli sbalzi di temperatura
- Chiusura di sicurezza con chiave (viteria e tasselli inclusi)

### Hand towel dispenser (600 sheets)

- 100% recycled ABS base and cover
- Polycarbonate front viewing window
- Holds Z, C, V, M-fold paper towel
- Capacity up to 600 sheets
- Quick and easy dispensing from below
- Versatile and innovative design
- Impact and temperature resistant
- Security lock with key (screw and plugs included)



DISPONIBILE IN AR SU MEDIAL APP  
AVAILABLE IN AR ON MEDIAL APP



ATTENZIONE: alcuni prodotti in plastica riciclata possono subire leggere variazioni di tonalità cromatica  
WARNING: some recycled plastic products may have slight variations in colour shade

Distributore carta asciugamani 600 fogli (z)  
Hand towel dispenser 600 sheets (z-folded)

920020

## STILECO

Erogazione "push"  
Push-operated

1 L



0,7 L



260 mm  
95 mm  
130 mm

210 mm  
90 mm  
128 mm

### Distributori di sapone liquido e gel (1 L e 0,7 L)

- Cover in ABS 100% riciclato
- Visore di controllo in policarbonato
- Serbatoio in plastica a riempimento da 1 L o 0,7 L
- Adatto per saponi liquidi e gel idroalcolici
- Sistema d'erogazione "push"
- Design versatile e innovativo
- Resistente agli urti e agli sbalzi di temperatura
- Chiusura di sicurezza con chiave (viteria e tasselli inclusi)

### Liquid soap and gel dispensers (1 L and 0,7 L)

- 100% recycled ABS cover
- Polycarbonate front viewing window
- Refillable plastic tank 1 L or 0,7 L
- Suitable for soaps and hydroalcoholic gels
- Push-operated dispensing system
- Versatile and innovative design
- Impact and temperature resistant
- Security lock with key (screw and plugs included)



DISPONIBILE IN AR SU MEDIAL APP  
AVAILABLE IN AR ON MEDIAL APP



ATTENZIONE: alcuni prodotti in plastica riciclata possono subire leggere variazioni di tonalità cromatica  
WARNING: some recycled plastic products may have slight variations in colour shade



Erogazione Push  
Push-Operated



Tanica a riempimento  
Refillable tank

Distributore sapone push bianco 1 L  
Liquid soap dispenser white 1 L  
Distributore sapone push bianco 0,7 L  
Liquid soap dispenser white 0,7 L

920041

920040





## STILECO

MINI  
JUMBO



272 mm  
125 mm  
253 mm

MAXI  
JUMBO



326 mm  
125 mm  
304 mm



Punto D'estrazione  
Release of Paper



Adattatore  
Adapter



### Distributore carta igienica in rotolo

- Base e cover in ABS 100% riciclato
- Visore di controllo in policarbonato
- Diametro max. rotolo **MINI JUMBO**: Ø 245 mm
- Diametro max. rotolo **MAXI JUMBO**: Ø 275 mm
- Mandrino: da 40 mm a max. 60 mm
- Erogazione dal basso, facile e veloce
- Design versatile e innovativo
- Resistente agli urti e agli sbalzi di temperatura
- Chiusura di sicurezza con chiave (viteria e tasselli inclusi)

### Toilet paper roll dispenser

- 100% recycled ABS base and cover
- Polycarbonate front viewing window
- Max. **MINI JUMBO** roll diameter: Ø 245 mm
- Max. **MAXI JUMBO** roll diameter: Ø 275 mm
- Spindle Ø 45 to 60 mm max.
- Quick and easy dispensing from below
- Versatile and innovative design
- Impact and temperature resistant
- Security lock with key (screw and plugs included)



DISPONIBILE IN AR SU MEDIAL APP  
AVAILABLE IN AR ON MEDIAL APP



ATTENZIONE: alcuni prodotti in plastica riciclata possono subire leggere variazioni di tonalità cromatica  
WARNING: some recycled plastic products may have slight variations in colour shade

Distributore Mini jumbo di carta igienica in rotolo  
Mini jumbo toilet paper dispenser

920001

Distributore Maxi jumbo di carta igienica in rotolo  
Maxi jumbo toilet paper dispenser

920002

## STILECO

500  
F



277 mm  
135 mm  
135 mm



### Distributore carta igienica interfogliata o in rotolo

- Base e cover in ABS 100% riciclato
- Visore di controllo in policarbonato
- Per carta igienica interfogliata o rotoli carta igienica
- Capienza 500 fogli (2 rotoli standard)
- Erogazione dal basso, facile e veloce
- Design versatile e innovativo
- Resistente agli urti e agli sbalzi di temperatura
- Chiusura di sicurezza con chiave (viteria e tasselli inclusi)

### Interfold or roll toilet tissue dispenser

- 100% recycled ABS base and cover
- Polycarbonate front viewing window
- For interfold toilet tissues or standard toilet paper rolls
- Holds 500 interfolded sheets (or 2 stand. rolls)
- Quick and easy dispensing from below
- Versatile and innovative design
- Impact and temperature resistant
- Security lock with key (screw and plugs included)



DISPONIBILE IN AR SU MEDIAL APP  
AVAILABLE IN AR ON MEDIAL APP



ATTENZIONE: alcuni prodotti in plastica riciclata possono subire leggere variazioni di tonalità cromatica  
WARNING: some recycled plastic products may have slight variations in colour shade

Distrib. carta interfogliata 500 fogli (2 rotoli)  
Interfold toilet tissue dispenser 500 s (2 rolls)

920005



## STILECO

MAXI



325 mm  
240 mm  
240 mm

MINI



285 mm  
150 mm  
140 mm



### Distributore di carta a srotolamento centrale

- Base e cover in ABS 100% riciclato
- Visore di controllo in policarbonato
- Diametro max. rotolo vers. **MAXI: Ø 230 mm**
- Diametro max. rotolo vers. **MINI: Ø 120 mm**
- Design versatile e innovativo
- Resistente agli urti e agli sbalzi di temperatura
- Chiusura di sicurezza con chiave (viteria e tasselli inclusi)

### Center pull towel dispenser

- **100% recycled ABS base and cover**
- Polycarbonate front viewing window
- Max. roll diameter vers. **MAXI: Ø 230 mm**
- Max. roll diameter vers. **MINI: Ø 120 mm**
- Versatile and innovative design
- Impact and temperature resistant
- Security lock with key (screw and plugs included)



ATTENZIONE: alcuni prodotti in plastica riciclata possono subire leggere variazioni di tonalità cromatica  
WARNING: some recycled plastic products may have slight variations in colour shade

Distributore di carta MAXI  
MAXI center pull dispenser

920031

Distributore di carta MINI  
MINI center pull dispenser

920030

## STILECO



382 mm  
233 mm  
280 mm



### Distributore autocut per carta asciugamani

- Base e cover in ABS 100% riciclato
- Funzionamento meccanico con taglio carta in trazione
- Visore di controllo in policarbonato
- Diametro max. rotolo: **Ø 210 mm**
- Larghezza max. rotolo: **195-205 mm**
- Lunghezza del taglio: 270 mm
- Resistente agli urti e agli sbalzi di temperatura
- Chiusura di sicurezza con chiave (viteria e tasselli inclusi)

### Autocut towel paper dispenser

- **100% recycled ABS base and cover**
- Works mechanically by tearing towel off
- Polycarbonate front viewing window
- Max. roll diameter: **Ø 210 mm**
- Max. roll width: **195-205 mm**
- Sheet length: 270 mm
- Impact and temperature resistant
- Security lock with key (screw and plugs included)



ATTENZIONE: alcuni prodotti in plastica riciclata possono subire leggere variazioni di tonalità cromatica  
WARNING: some recycled plastic products may have slight variations in colour shade

Distributore autocut carta asciugamani  
Autocut paper towel dispenser

920050



Punto D'estrazione  
Release of Paper



Portarotolo  
Roll Holder



## AUTOCUT



370 mm  
240 mm  
350 mm

### Distributore autocut per carta asciugamani

- Base e cover in ABS bianco
- Funzionamento meccanico con taglio carta in trazione
- Per rotolo non pretagliato
- Dim. max rotolo: Ø 210 mm, larghezza 210 mm
- Lunghezza del taglio: 240 mm
- Chiusura con chiave in plastica
- Facile caricamento del rotolo
- Viteria inclusa

### Autocut towel paper dispenser

- White ABS backing and cover
- Works mechanically by tearing towel off
- For non-perforated roll towel
- Roll dim.: max. Ø 210 mm, max. width 210 mm
- Sheet length: 240 mm
- Plastic keyed lock
- Easy and fast to load the paper
- Fixing hardware included



Distributore autocut carta asciugamani  
*Autocut paper towel dispenser*

709054

## MINI AUTOCUT



330 mm  
204 mm  
314 mm

### Mini distributore autocut per carta asciugamani

- Base in ABS trasparente e cover in ABS bianco
- Funzionamento meccanico con taglio carta in trazione
- Per rotolo non pretagliato
- Dim. max rotolo: Ø 195 mm, larghezza 210 mm
- Lunghezza del taglio: 230 mm
- Chiusura con chiave in plastica
- Facile caricamento del rotolo
- Viteria inclusa

### Mini autocut towel paper dispenser

- Transparent ABS backing and white ABS cover
- Works mechanically by tearing towel off
- For non-perforated roll towel
- Roll dim.: max. Ø 195 mm, max. width 210 mm
- Sheet length: 230 mm
- Plastic keyed lock
- Easy and fast to load the paper
- Fixing hardware included



Mini distributore autocut carta asciugamani  
*Mini autocut paper towel dispenser*

709052



## MAROLL VERTICALE



340 mm  
260 mm

### Maxi distributore carta a srotolamento centrale

- Base in ABS bianco e calotta in ABS trasparente
- Per rotolo asciugamano a sfilamento centrale
- Dim.max rotolo: (Ø) 245 mm x (L) 265 mm
- Chiusura con chiave in plastica
- Viteria inclusa

### Maxi center pull towel paper dispenser

- White ABS base and transparent ABS fairing
- Suitable for center feed roll paper
- Max. roll dimensions: (Ø) 245 mm x (L) 265 mm
- Plastic keyed lock
- Fixing hardware included



ABS bianco - blu trasparente  
Blue transparent - white ABS

700519

## BASICA



Varianti colore  
Colors available



356 mm  
214 mm  
240 mm

### Distributore di carta a srotolamento centrale

- Base in ABS grigio e cover in ABS blu trasparente o bianco
- Per rotolo pretagliato a sfilamento centrale
- Dim. max. rotolo: Ø 200 mm - larghezza 200 mm
- Chiusura con chiave in plastica e viteria inclusa

### Center pull towel dispenser

- Grey ABS backing and blue transparent or white ABS cover
- Holds pre-cut center pull paper roll
- Max. roll dim.: Ø 200 mm - width 200 mm
- Plastic keyed cover and fixing hardware included



Distributore di carta blu trasparente  
Blue transparent center pull dispenser

104024

Distributore di carta bianco  
White center pull dispenser

104025

## WAVE



Varianti colore  
Colors available



310 mm  
210 mm  
220 mm

### Distributore di carta a srotolamento centrale

- Struttura in ABS o ABS/SAN
- Per rotolo non pretagliato a sfilamento centrale
- Dim. max rotolo: Ø 190 mm x larghezza 210 mm
- Chiusura con chiave in plastica
- Viteria inclusa

### Center pull towel paper dispenser

- Backing and shell made from ABS or ABS/SAN
- Holds unpre-cut center pull paper roll
- Max. roll dimension: Ø 190 mm x width 210 mm
- Plastic keyed cover
- Fixing hardware included



Distributore di carta blu trasparente  
Blue transparent center pull dispenser

908124

Distributore di carta bianco  
White center pull dispenser

908024



## ROLIND

Reggisacco in opzione  
Sack holder as option

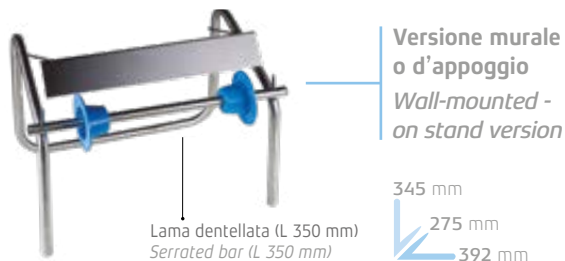

### Portarotolo industriale

- Acciaio inox AISI 304 brillante o metallo verniciato bianco
- Compatibile con rotoli di Ø esterno max. 350 mm
- Compatibile con rotoli aventi anima interna Ø min. 20 mm
- Lama dentellata per un taglio facile della carta
- Due coni blocca-rotolo (Ø min. 42 mm, Ø max. 55 mm) con gommini
- Reggisacco in metallo acquistabile separatamente

### Industrial towel roll holder

- AISI 304 polished s.steel or powder epoxy coated steel
- Holds one roll having external Ø 350 mm
- Compatible with roll having an inner carton tube Ø 20 mm min.
- Roll holder bar 430 mm
- Paper can be cut easily with the adjustable serrated bar
- Plastic cones hold the roll securely in place (Ø min. 42 mm, Ø max. 55 mm)
- Sack holder as option, sold separately



Metallo bianco murale o d'appoggio White coated steel (wall-mounted or on stand)	700014
Inox AISI 304 murale o d'appoggio AISI 304 s.steel (wall-mounted or on stand)	753233
Metallo bianco da appoggio White coated steel (on stand)	700030
Inox AISI 304 da appoggio AISI 304 s.steel (on stand)	707005
Reggisacco in metallo bianco White metal sack holder	700050

## ROLIND BASIC



295 mm  
265 mm  
380 mm

### Portarotolo industriale murale

- Acciaio inox AISI 304 brillante o metallo verniciato bianco
- Compatibile con rotoli di Ø esterno max. 260 mm
- Compatibile con rotoli aventi anima interna Ø min. 20 mm
- Tubo reggi-rotolo lungo 380 mm
- Lama dentellata (L 350 mm) per un taglio facile della carta
- Coni bloccarotolo (Ø min. 42 mm, Ø max. 55 mm) con gommini
- Fissaggio murale

### Wall-mounted industrial towel roll holder

- AISI 304 s.steel or powder epoxy coated steel
- Holds one roll having external Ø 260 mm
- Compatible with roll having an inner carton tube Ø 20 mm min.
- Roll holder bar 380 mm
- Paper can be cut easily with the adjustable serrated bar (350 mm)
- Plastic cones hold the roll securely in place (Ø min. 42 mm, Ø max. 55 mm)
- Wall mounted fixing not kit included



Portarotolo murale metallo bianco Wall-mounted dispenser white steel	700015
Portarotolo murale inox 304 brillante Wall-mounted dispenser 304 polished steel	700010





## ROLIND EVO

Versione d'appoggio  
On stand version



790 mm  
350 mm  
400 mm

### Portarotolo industriale d'appoggio

- Acciaio inox AISI 304
- Diametro max. rotolo: **Ø 500 mm**
- Larghezza max. rotolo: **380 mm**
- Compatibile con rotoli aventi anima interna **Ø 70 mm**
- Lama dentellata in plastica per un taglio facile della carta
- Venduto in confezioni da 6 pezzi
- Viteria inclusa

### On stand industrial towel roll holder

- AISI 304 s.steel
- Max. roll diameter: **Ø 500 mm**
- Max. roll width: **380 mm**
- Compatible with roll having an inner carton tube **Ø 70 mm**
- Paper can be cut easily with the adjustable plastic serrated bar
- Sold 6 pcs per pack
- Screw and plugs included



Portarotolo industriale d'appoggio  
On stand industrial towel roll holder

920901

## ROLIND EVO



Versione murale  
Wall-mounted version

450 mm  
190 mm  
400 mm

### Portarotolo industriale murale o d'appoggio

- Acciaio inox AISI 304
- Assale, mandrino e supporto in ABS
- Diametro max. rotolo: **Ø 500 mm**
- Larghezza max. rotolo: **380 mm**
- Compatibile con rotoli aventi anima interna **Ø 70 mm**
- Lama dentellata in plastica per un taglio facile della carta
- Venduto in confezioni da 6 pezzi
- Viteria inclusa

### Wall-mounted or on stand industrial towel roll holder

- AISI 304 s.steel
- ABS axle, spindle and support
- Max. roll diameter: **Ø 500 mm**
- Max. roll width: **380 mm**
- Compatible with roll having an inner carton tube **Ø 70 mm**
- Paper can be cut easily with the adjustable plastic serrated bar
- Sold 6 pcs per pack
- Screw and plugs included



Versione d'appoggio  
Stand version



530 mm  
190 mm  
400 mm



Portarotolo industriale murale o d'appoggio  
Wall-mounted or on stand industrial towel roll holder

920900



## BIMBI



510 mm  
513 mm  
872 mm

### Fasciatoio

- Struttura in LDPE bianco con profilo compatto ultrasottile
- Cardini ad alta resistenza, modellati in un unico pezzo
- Cerniera ammortizzata a gas per aperture e chiusure in massima sicurezza
- Doppio dispenser di fazzolettini integrato
- Doppio gancio integrato per appendere le borse
- Profilo interno ad ampio raggio per garantire comfort e sicurezza
- Cintura di sicurezza
- Testato e approvato per bimbi fino a 12 mesi o fino a 11 kg

### Baby changing table

- White micro-textured LDPE plastic unit, with compact ultra slim profile
- Heavy-duty integral molded hinges for strength & safety
- Dampened gas strut for controlled & safe opening/closing
- Easy fully integrated dual liner dispensers, for hygiene assurance
- Twin bag hooks
- Large radius internal contours for comfort and safety
- Unique single action retaining strap fastener
- Tested and approved for babies up to 12 months or up to 11 kg



Conforme allo standard europeo EN 12221-1:2013-12 Tipo 1  
In compliance with European standard EN 12221-1:2013-12 Type 1

Bimbi fasciatoio bianco  
White baby changing station Bimbi

707100

## NINNA

Modello verticale  
Vertical



890 mm  
890 mm  
550 mm

### Fasciatoio

- Struttura in polietilene ad alta densità bianco con profilo compatto
- Cerniera d'apertura in acciaio con pistone ammortizzato
- Piastre posteriori di montaggio in acciaio
- Cintura di sicurezza in nylon, impermeabile e regolabile
- Ripiano largo e confortevole con bordi laterali anti-caduta
- Etichetta adesiva con pittogramma e kit installazione inclusi
- Testato per un peso massimo fino a 15 Kg
- Conforme alla direttiva CE 93/42/EEC - allegato V
- Conforme alla norma EN 12221: 2008
- Certificato TUV

### Baby changing table

- White high-quality HDPE unit with compact profile
- Full length steel-on-steel hinges and pneumatic cylinder
- Steel mounting back plates
- Adjustable child safety belt from nylon
- Comfortable and safe changing table
- Sticker and mounting kit included
- Tested up to 15 Kg max. weight
- In compliance with CE council directive 93/42/EEC, annex V
- In compliance with EN 12221: 2008 norm
- TUV certified



Certificato TUV e conforme allo standard europeo EN 12221:2008  
TUV certified and in compliance with European standard EN 12221:2008

Fasciatoio orizzontale  
Horizontal baby changing station

117101

Fasciatoio verticale  
Vertical baby changing station

117106

Modello orizzontale  
Horizontal



480 mm  
489 mm  
895 mm



# SIMPLY

## Accessori da bagno

- ABS bianco
- Facile montaggio e manutenzione
- Viteria inclusa

## Bathroom accessories

- White ABS
- Easy to install and maintain
- Fixing hardware included

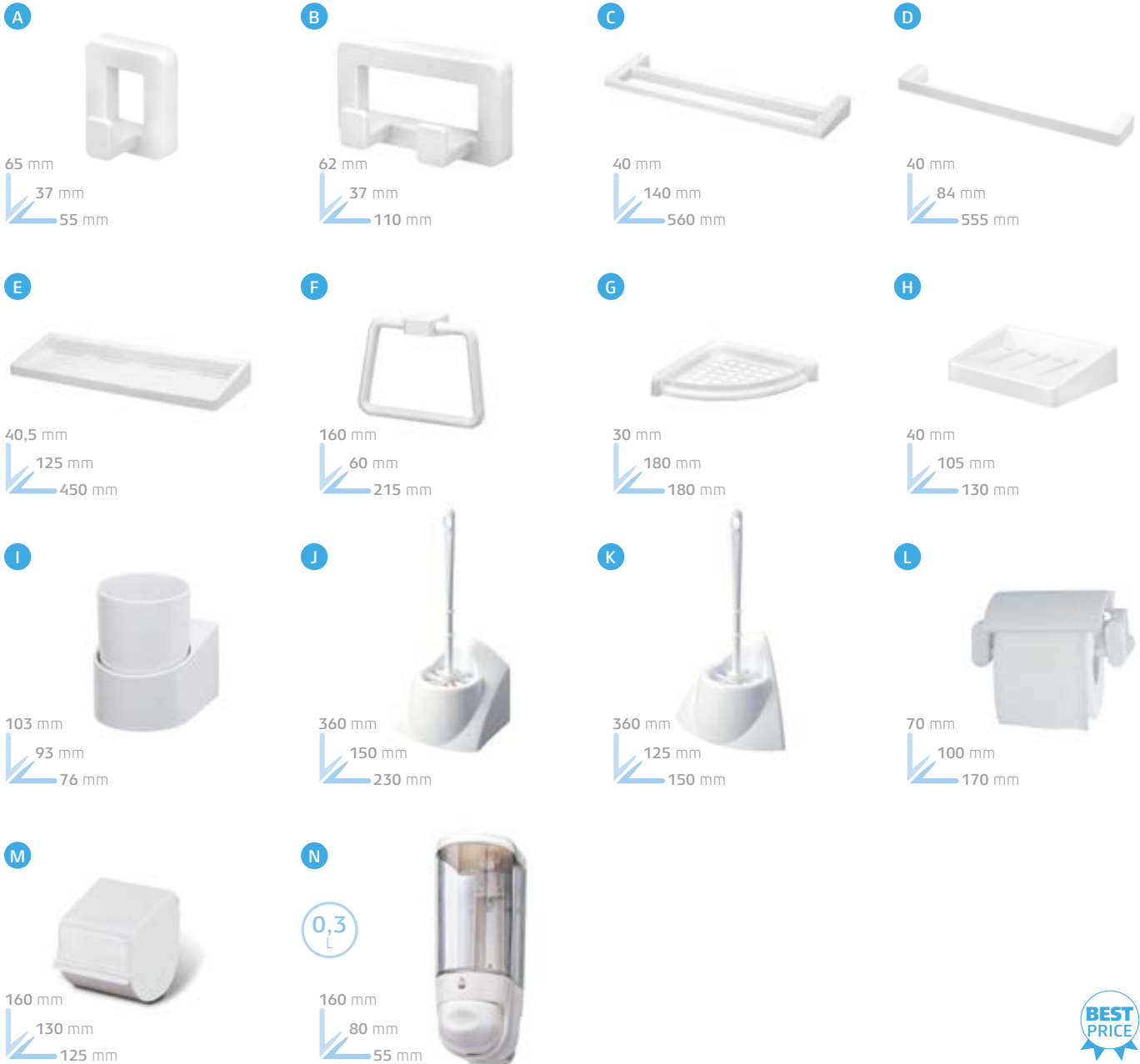

<b>A</b>	Appendiabito 1 gancio <i>Single hook bathrobe hanger</i>	<a href="#">111000</a>
<b>B</b>	Appendiabito 2 ganci <i>Double hooks bathrobe hanger</i>	<a href="#">111003</a>
<b>C</b>	Porta asciugamani 2 barre <i>Double bar towel holder</i>	<a href="#">111004</a>
<b>D</b>	Porta asciugamani 1 barra <i>Single bar towel holder</i>	<a href="#">111005</a>
<b>E</b>	Mensola <i>Shelf</i>	<a href="#">111006</a>
<b>F</b>	Porta asciugamani ad anello <i>Towel ring</i>	<a href="#">111007</a>
<b>G</b>	Portasapone angolare <i>Corner soap holder</i>	<a href="#">104113</a>

<b>H</b>	Portasapone <i>Soap holder</i>	<a href="#">111017</a>
<b>I</b>	Portabicchiere <i>Glass holder</i>	<a href="#">111018</a>
<b>J</b>	Portascopino quadrato <i>Square toilet brush holder</i>	<a href="#">906450</a>
<b>K</b>	Portascopino angolare <i>Corner toilet brush holder</i>	<a href="#">906451</a>
<b>L</b>	Porta rotolo carta igienica <i>Toilet tissue roll dispenser</i>	<a href="#">104101</a>
<b>M</b>	Porta rotolo chiuso per carta igienica <i>Toilet paper roll holder with casing</i>	<a href="#">710010</a>
<b>N</b>	Distributore sapone da 0,3 L <i>Soap dispenser tank x 0,3 L</i>	<a href="#">110550</a>



## KATY

### Accessori da bagno

- Acciaio inox AISI 304 brillante
- Design moderno ed elegante
- Facile montaggio e manutenzione
- Viteria inox inclusa

### Bathroom accessories

- AISI 304 polished stainless steel
- Sleek and modern design
- Easy to install and maintain
- Stainless steel fixing hardware included



50 mm  
80 mm  
380 mm



100 mm  
220 mm  
530 mm



50 mm  
60 mm  
75 mm



60 mm  
50 mm  
50 mm



50 mm  
130 mm  
530 mm



50 mm  
80 mm  
530 mm

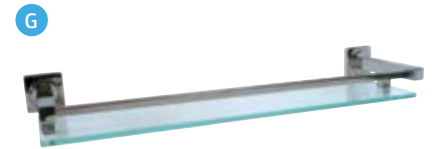

50 mm  
145 mm  
550 mm



135 mm  
60 mm  
160 mm



440 mm  
130 mm  
130 mm



50 mm  
160 mm  
60 mm



57 mm  
92 mm  
92 mm



60 mm  
165 mm  
250 mm



50 mm  
105 mm  
155 mm

<b>A</b>	Appendiabito 4 ganci <i>Bathrobe hanger with 4 hooks</i>	<a href="#">105101</a>
<b>B</b>	Porta biancheria <i>Bath towels shelf</i>	<a href="#">105102</a>
<b>C</b>	Appendiabito 2 ganci <i>Double hooks bathrobe hanger</i>	<a href="#">105103</a>
<b>D</b>	Appendiabito 2 ganci <i>Double hooks bathrobe hanger</i>	<a href="#">105203</a>
<b>E</b>	Porta asciugamani 2 barre <i>Double bar towel holder</i>	<a href="#">105104</a>
<b>F</b>	Porta asciugamani 1 barra <i>Single bar towel holder</i>	<a href="#">105105</a>

<b>G</b>	Mensola <i>Glass shelf</i>	<a href="#">105106</a>
<b>H</b>	Porta asciugamani ad anello <i>Towel ring</i>	<a href="#">105107</a>
<b>I</b>	Portascopino murale <i>Wall mounted toilet brush holder</i>	<a href="#">105108</a>
<b>J</b>	Porta rotolo <i>Toilet paper holder</i>	<a href="#">105109</a>
<b>K</b>	Filo stendibiancheria 2,5 M <i>Retractable clothes line 2,5 M</i>	<a href="#">105042</a>
<b>L</b>	Ripiano angolare <i>Corner shelf</i>	<a href="#">105113</a>



N



245 mm  
102 mm  
48 mm

O



200 mm  
370 mm  
260 mm  
Con luce a led / With led light

P



320 mm  
230 mm  
350 mm

Q



400 mm  
135 mm  
135 mm

R



100 mm  
110 mm  
70 mm

S



155 mm  
100 mm  
70 mm

T



50 mm  
110 mm  
120 mm

U



50 mm  
60 mm  
80 mm  
Finitura satinata  
Brushed finish

V



278 mm  
205 mm  
205 mm

W



0,3 L

160 mm  
80 mm  
55 mm

#### Mini distributore di sapone liquido

- Base in ABS cromato e cover in policarbonato trasparente
- Tanica a riempimento (0,3 L)
- Per tutti i tipi di sapone, salvo a microgranuli
- Serratura in plastica e viteria inclusa

#### Mini liquid soap dispenser

- Chromed ABS backing and transparent polycarbonate cover
- Refillable tank (0,3 L)
- For all kind of liquid soaps, except for microbead soaps
- Plastic keyed lock and fixing hardware included

M	Porta sapone a filo Soap holder	105111
N	Porta rotolo di riserva Spare toilet paper roll holder	105112
O	Specchio ingranditore 3x con luce a led (ø 215 mm) 3x magnifying mirror with Led light (ø 215 mm)	105119
P	Specchio ingranditore 3x (ø 200 mm) 3x magnifying mirror (ø 200 mm)	130110
Q	Portascopino in vetro Glass toilet brush holder	105115
R	Portabicchiere Toilet glass holder	105118

S	Portasapone liquido Liquid soap holder	105116
T	Portasapone Soap holder	105117
U	Supporti per specchio (finitura satinata) Mirror holders (brushed finish)	105114
V	Pattumiera a pedale inox AISI 304 5 L AISI 304 s.steel pedal bin 5 L	906705
W	Distributore sapone da 0,3 L - ABS cromato Soap dispenser tank x 0,3 L - chromed ABS	110551





## NARCISO PACK



### Specchio rettangolare

- Specchio in vetro di alta qualità
- Confezionamento speciale in cassa di legno
- Pellicola di sicurezza
- Può essere installato orizzontalmente
- Kit di fissaggio murale incluso

### Rectangular mirror

- High-quality frameless glass mirror
- Special packaging in a wooden crate
- Security film
- To be hanged horizontally or vertically
- Wall mounting kit included



800 mm  
30 mm  
600 mm

Specchio in vetro rettangolare  
Rectangular glass mirror

710125





## ACRIL



700 mm  
6 mm  
500 mm

### Specchio acrilico infrangibile

- Lastra acrilica da 3 mm con finitura a specchio
- Rinforzo in legno da 3 mm
- Leggero, infrangibile e anti-infortunistico
- Fissaggio con viti o biadesivo (non inclusi) - **(non utilizzare silicone)**
- Ideale in piscine, scuole, palestre, carceri, ospedali, aeroporti
- Supporti basculanti in inox AISI 304 satinato in opzione (cod. 105114)

### Shatterproof acrylic mirror

- Acrylic sheet (3 mm) with mirror finish
- Back wood panel (3 mm)
- Ultra-light, safe & shatterproof
- High optical property
- Hang with screws or double-sided tape (not included) **(do not use silicone)**
- Ideal for swimming pools, schools, gyms, prisons, hospital, airports
- Brushed AISI 304 s.steel swing back brackets on request (cod. 105114)



400 mm  
6 mm  
500 mm



500 mm  
6 mm  
700 mm



Supporti inox satinato  
Brushed s.steel rackets

Rettangolare 400x500 mm <i>Rectangular 400x500mm</i>	150010
Rettangolare 500x700 mm <i>Rectangular 500x700mm</i>	150011
Ovale 500x700 mm <i>Oval 500x700mm</i>	150012
Supporti Katy per basculamento <i>Katy's swing brackets</i>	105114

## SIMPLY



470 mm  
35 mm  
470 mm

### Specchio con cornice bianca

- Specchio in vetro
- Cornice bianca in ABS

### Round mirror with white frame

- Glass mirror
- White ABS frame



490 mm  
35 mm  
490 mm

Specchio quadrato (460x460 mm) <i>Squared mirror (460x460 mm)</i>	150000
Specchio rotondo (Ø 500 mm) <i>Round mirror (Ø 500 mm)</i>	150005



MILADY

NEW



#### Dispenser porta assorbenti

- Acciaio zincato verniciato con polvere poliestere
- Colore bianco RAL 9003
- Sportello frontale incernierato
- Adesivi già applicati
- 3 scompartimenti per diverse tipologie di assorbenti
- Ideale per servizi nelle scuole, ospedali, uffici, ristoranti, hotel ecc...
- Fissaggio murale, kit incluso
- Chiusura di sicurezza con chiave

#### Sanitary pads dispenser

- Galvanised steel coated with polyester powder
- White color RAL 9003
- Hinged front door
- Pre-applied stickers
- 3 compartments for different types of sanitary pads
- Ideal for services in schools, hospitals, offices, restaurants, hotels, etc.
- Wall mounting, kit included
- Security lock with key



DISPONIBILE IN AR SU MEDIAL APP  
AVAILABLE IN AR ON MEDIAL APP



432 mm  
138 mm  
375 mm



Chiave e serratura  
Key and Lock



Vani di ricarica  
Refill compartments



Punti D'estrazione  
Release Of pads

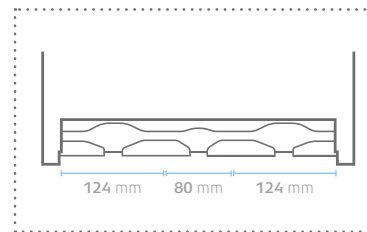

Dispenser porta assorbenti  
Sanitary pads dispenser

789100





## RELAX



40 mm  
440 mm  
375 mm

### Sedile copriwater

- Sedili WC in thermodur
- Cerniere in lega d'alluminio
- Chiusura silenziosa
- Viteria in acciaio zincato

### Toilet seat

- Duroplast toilet seat
- Aluminium hinges
- Soft closing system
- Galvanized steel fixing hardware

Sedile WC in thermodur  
Duroplast toilet seat

120006

## ATIS



40 mm  
460 mm  
370 mm

### Sedile copriwater

- Sedile in PP antibatterico
- Coperchio in PP antibatterico
- Cerniere a chiusura silenziosa
- Gommini paracolpi
- Viteria in plastica

### Toilet seat

- Antibacterial PP toilet seat
- Soft and quiet close lid
- Rubber bumpers
- Quick install & release hinges
- Plastic screws

Sedile WC in PP antibatterico  
Antibacterial PP toilet seat

120011

## RELAX



40 mm  
440 mm  
375 mm

### Sedile copriwater

- Sedili WC in MDF laccato
- Cerniere in plastica
- Viteria in plastica

### Toilet seat

- White MDF toilet seat
- Plastic hinges
- Plastic fixing hardware

Sedile copriwater in MDF laccato  
White MDF toilet seat

120001

## LINDER



40 mm  
460 mm  
360 mm

### Sedile copriwater

- Sedile in PP antibatterico
- Coperchio in PP antibatterico
- Cerniere in plastica
- Gommini paracolpi
- Viteria in plastica

### Toilet seat

- Antibacterial PP toilet seat
- Antibacterial PP lid
- Plastic hinges
- Rubber bumpers
- Plastic screws

Sedile copriwater in PP antibatterico  
Antibacterial PP toilet seat

120010



## URINAL NET

### Retina per orinatoio

- Retina anti schizzo in polietilene
- Mantiene gli orinatoio profumati fino a 30 giorni
- Rilascia la profumazione in modo costante nel tempo
- Evita l'intasamento degli scarichi
- Venduta in buste termosaldate da 2 pezzi

### Urinal screen

- Anti-splash urinal screen made from polyethylene
- Keeps urinals smelling fresh for up to 30 days
- Releases scent consistently over time
- Avoids pipe clogs
- Sold in 2 pieces sealed bags



TROPICAL  
TROPICAL

180 mm  
5 mm  
180 mm



ARANCIA & CANNELLA  
ORANGE & CINNAMON

180 mm  
5 mm  
180 mm



Urinal Net Tropical  
*Urinal Net Tropical*

83000399

Urinal Net Arancia Cannella  
*Urinal Net Orange Cinnamon*

83000499

## CARTA



255 mm  
35 mm  
195 mm

### Carta copriwater biodegradabile

- Carta biodegradabile da 14 gr o 18 gr
- Confezione da 200 fogli
- Cod. 109114 venduto in cartone da 25 confezioni
- Cod. 109118 venduto in cartone da 10 confezioni

### Biodegradable toilet seat cover

- Biodegradable paper (14 gr or 18 gr)
- 200 toilet seat covers per pack
- Cod. 109114 sold 25 packs per carton
- Cod. 109118 sold 10 packs per carton

Carta copriwater 14 gr  
*Toilet seat cover 14 gr*

109114

Carta copriwater 18 gr  
*Toilet seat cover 18 gr*

109118



DIFFUSORI DI PROFUMO

*AIR FRESHENERS*







## EXPLOSION

### Diffusore di profumo per nebulizzazione

- Scocca in ABS bianco (disponibile anche nero per la versione WI-FI)
- Sofisticata tecnologia di nebulizzazione (particelle < 5 micron)
- Display di programmazione digitale (LCD)
- Copertura in ambienti chiusi fino a 300 m<sup>3</sup> (100 m<sup>2</sup> circa)
- Serbatoio interno in plastica da 200 ml
- 4 scenari di programmazione - Scelta dei giorni di attivazione (17 opzioni disp)
- Settaggio degli intervalli di attivazione/pausa della nebulizzazione (5-300 sec.)
- Silenziosità: <50 dBa
- Funzionamento tramite alimentatore di corrente 12 V (incluso)
- Possibilità d'appoggio o installazione murale (kit fissaggio incluso)
- **Possibilità programmazione da smartphone/tablet (solo per versione WI-FI)**
- Ampia scelta tra le profumazioni della linea Explosion Parfume

### Fragrance diffuser for atomisation

- White ABS shell (WI-FI version also available in black color)
- Sophisticated fragrance atomisation technology
- Digital programming display (LCD)
- Effective in room sizes up to 300 m<sup>3</sup> (about 100 m<sup>2</sup>)
- Internal 200 ml plastic tank
- 4 programming scenarios - Choice of activation (17 options available)
- Choice of the activation/pause atomisation periods (5-300 sec.)
- Noise level: <50 dBa
- Operated by 12 V AC adapter (included)
- Freestanding or wall holder (fixing kit included)
- **Wi-Fi version allows remote programming via smartphone/tablet**
- Wide choice of "Explosion parfume" fragrances



230 mm  
86 mm  
170 mm

Versione WI-FI  
Wi-Fi version



Punto d'erogazione  
Dispensing point



Apertura  
Opening



Preso alimentatore  
Power supply socket

Diffusore di profumo - ABS bianco Fragrance diffuser - White ABS	117000
Diffusore di profumo WIFI - ABS bianco WIFI fragrance diffuser - White ABS	117001
Diffusore di profumo WIFI - ABS nero WIFI fragrance diffuser - Black ABS	117021





## EXPLOSION 80

Versione murale o d'appoggio  
Wall-mounted - on stand version



220 mm  
93 mm  
106 mm

### Diffusore di profumo per nebulizzazione

- Struttura in plastica (PP) bianca o nera
- Copertura: 100 m<sup>3</sup> ( 35 m<sup>2</sup> circa)
- Schermo LCD
- Funzionamento silenzioso (< 50 dBA)
- Usa 3 batterie di tipo "C" o cavo USB da 5V (non inclusi)
- Tanica da 100 ml
- Possibilità d'appoggio o installazione murale (kit fissaggio incluso)
- Programmazione Smart:
  - 6 eventi programmabili - impostazione 24 ore (ON/OFF);
  - controllo concentrazione di profumo
- Ampia scelta tra le profumazioni della linea Explosion Parfume

### Fragrance diffuser for atomisation

- Black or white plastic material (PP)
- Coverage area: 100 m<sup>3</sup> (about 35 m<sup>2</sup>)
- LCD screen
- Silent operation low noise reduction (< 50 dBA)
- Use 3 pcs of "C" battery or USB 5V cable (both not included)
- Bottle capacity 100 ml
- Freestanding or wall holder (fixing kit included)
- Smart program controller:
  - 6 events control; 24 Hour setting system (ON/OFF);
  - smell concentration control
- Wide choice of "Explosion perfume" fragrances



DISPONIBILE IN AR SU MEDIAL APP  
AVAILABLE IN AR ON MEDIAL APP



Diffusore di profumo - PP bianco  
Fragrance diffuser - White PP

117010

Diffusore di profumo - PP nero  
Fragrance diffuser - Black PP

117011

## EXPLOSION 200



290 mm  
113 mm  
113 mm

### Diffusore di profumo per nebulizzazione

- Struttura in alluminio anodizzato nero o argento
- Copertura: 200 m<sup>3</sup> ( 70 m<sup>2</sup> circa)
- Schermo LCD
- Funzionamento silenzioso
- Adattatore DC 12V (incluso)
- Tanica da 60 ml
- Installazione su piano d'appoggio
- Programmazione Smart:
  - 4 eventi programmabili - impostazione 24 ore;
  - controllo concentrazione di profumo
- Ampia scelta tra le profumazioni della linea Explosion Parfume

### Fragrance diffuser for atomisation

- Black or silver anodized aluminium housing
- Coverage area: 200 m<sup>3</sup> (about 70 m<sup>2</sup>)
- LCD screen
- Silent operation low noise reduction
- Power supply DC 12 V (included)
- Bottle capacity 60 ml
- Freestanding
- Smart program controller
  - 4 events control; 24 Hour setting system;
  - smell concentration control
- Wide choice of "Explosion perfume" fragrances



DISPONIBILE IN AR SU MEDIAL APP  
AVAILABLE IN AR ON MEDIAL APP



Diffusore di profumo - Nero  
Fragrance diffuser - Black

117131

Diffusore di profumo - Argento  
Fragrance diffuser - Silver

117132



## EXPLOSION 1500



530 mm  
195 mm  
195 mm

### Diffusore di profumo per nebulizzazione

- Struttura in alluminio anodizzato nero o argento
- Copertura: 1000 m<sup>3</sup>
- Controllo da telecomando
- Funzionamento silenzioso
- Adattatore DC 12V (incluso)
- Tanica da 500 ml
- Installazione su piano d'appoggio
- Programmazione Smart:
  - 4 eventi programmabili - impostazione 24 ore;
  - controllo concentrazione di profumo
- Ampia scelta tra le profumazioni della linea Explosion Parfume

### Fragrance diffuser for atomisation

- Black or silver anodized aluminium housing
- Coverage area: 1000 m<sup>3</sup>
- Remote control
- Silent operation low noise reduction
- Power supply DC 12 V (included)
- Bottle capacity 500 ml
- Freestanding
- Smart program controller
  - 4 events control; 24 Hour setting system;
  - smell concentration control
- Wide choice of "Explosion parfume" fragrances



Diffusore di profumo - Nero  
Fragrance diffuser - Black

117111

Diffusore di profumo - Argento  
Fragrance diffuser - Silver

117112

## EXPLOSION 3000



638 mm  
195 mm  
195 mm

### Diffusore di profumo per nebulizzazione

- Struttura in alluminio anodizzato nero o argento
- Copertura: 3000 m<sup>3</sup>
- Controllo Wi-Fi esclusivamente da App
- Funzionamento silenzioso
- Adattatore DC 12V (incluso)
- Bottiglia in plastica da 1 L
- Installazione su piano d'appoggio
- Programmazione Smart:
  - 4 eventi programmabili - impostazione 24 ore;
  - controllo concentrazione di profumo
- Ampia scelta tra le profumazioni della linea Explosion Parfume

### Fragrance diffuser for atomisation

- Black or silver anodized aluminium housing
- Coverage area: 3000 m<sup>3</sup>
- Smart App exclusively control Wi-Fi
- Silent operation low noise reduction
- Power supply DC 12 V (included)
- 1 L plastic Bottle
- Freestanding
- Smart program controller
  - 4 events control; 24 Hour setting system;
  - smell concentration control
- Wide choice of "Explosion parfume" fragrances



GUARDA IL VIDEO  
WATCH THE MOVIE



DISPONIBILE IN AR SU MEDIAL APP  
AVAILABLE IN AR ON MEDIAL APP



Diffusore di profumo - Nero  
Fragrance diffuser - Black

117121

Diffusore di profumo - Argento  
Fragrance diffuser - Silver

117122





## BASICA



220 mm  
82 mm  
89 mm

### Diffusore automatico di profumo

- Base in ABS grigio e cover in ABS bianco
- Compatibile con ricariche standard 250/270 ml
- Diverse possibilità di programmazione
- Regolazione attivazione giorno/notte
- Regolazione frequenza di nebulizzazione (ogni 7,5 / 15 / 30 min.)
- Copertura in ambienti chiusi fino a 200 m<sup>3</sup>
- Alimentazione: 2 pile tipo D 1,5V (non incluse)
- Serratura in plastica
- Viteria inclusa

### Automatic air freshener

- Grey ABS backing and white ABS cover
- Suitable for standard aerosol cans (250/270 ml)
- Several setting options available
- Adjustable day/night operation
- Adjustable activation frequency (7,5 / 15 / 30 min)
- Coverage: effective in room sizes up to 200 m<sup>3</sup>
- Battery operated: 2 x D alkaline batteries (not included)
- Plastic keyed lock
- Fixing hardware included



Diffusore automatico di profumo  
Automatic air freshener

104060

## BASICA



244 mm  
80 mm  
90 mm

### Diffusore digitale automatico di profumo

- Base e cover in ABS bianco
- Pannello di programmazione completo di display LCD
- Compatibile con ricariche standard 250/270 ml
- Regolazione del giorno e dell'orario d'attivazione
- Regolazione dell'intervallo d'erogazione (1-60 min.)
- Copertura in ambienti chiusi fino a 200 m<sup>3</sup>
- Alimentazione: 2 pile tipo "D" 1,5 V (non incluse)
- Serratura in plastica
- Viteria inclusa

### Digital air freshener

- White ABS backing and cover
- Programming panel with LCD screen
- Accommodates aerosol cans (250/270 ml)
- Day and clock settings available
- Adjustable spray intervals setting (1-60 min)
- Suitable in room sizes up to 200 m<sup>3</sup>
- Battery operated: 2xD alkaline batteries (not included)
- Plastic keyed lock
- Fixing hardware included



Diffusore automatico di profumo digitale  
Digital air freshener

104062



## SOFFIO



215 mm  
85 mm  
93 mm

### Diffusore automatico di profumo

- Struttura in PP (polipropilene) bianco
- Diffusione spray
- Compatibile con ricariche da 250/270 ml
- Indicatori LED
- Regolazione attivazione 24H/giorno/notte
- Regolazione frequenza di erogazione (ogni 7,5 / 15 / 30 min.)
- Possibilità di regolare tempi e intervalli di funzionamento
- Alimentazione: 2 pile C LR14 - 1,5 V alcaline (non incluse)
- Serratura in plastica

### Automatic air freshener

- White PP (polypropylene)
- Spray diffusion
- Compatible with 250/270 ml refills
- LED indicators
- Adjustable 24H/day/night operation
- Adjustable activation frequency (7,5 / 15 / 30 min)
- Possibility of adjusting operating times and intervals
- Power supply: 2 x C LR14 - 1.5 V alkaline batteries (not included)
- Plastic lock



Foro di erogazione  
Dispensing hole



Pannello di controllo interno  
Inner control panel

Diffusore automatico di profumo  
Automatic air freshener

110540

## SOFFIO



240 mm  
85 mm  
82 mm

### Diffusore automatico di profumo

- Struttura in ABS bianco e base grigia
- Diffusione spray
- Compatibile con ricariche da 250/270 ml
- Display di programmazione digitale (LCD)
- Alimentazione: 2 pile D LR20 - 1,5 V alcaline (non incluse)
- Possibilità di regolare tempi e intervalli di funzionamento
- Indicatore luminoso per controllo carica batteria
- Serratura in plastica

### Automatic air freshener

- White ABS cover and grey back
- Spray diffusion
- Compatible with 250/270 ml refills
- Digital programming display (LCD)
- Power supply: 2 x D LR20 - 1.5 V alkaline batteries (not included)
- Possibility of adjusting operating times and intervals
- Indicator light for battery charge control
- Plastic lock



Foro di erogazione  
Dispensing hole



Pannello di controllo e display LCD  
Inner control panel and LCD display

Diffusore automatico di profumo  
Automatic air freshener

110542



## EXPLOSION PARFUME

### Fragranza liquida per diffusore di profumo Explosion

- Profumatore liquido privo di propellenti
- Utilizzabile solo con nebulizzatori o diffusori di fragranze
- Massima efficacia e persistenza della profumazione
- Neutralizza i cattivi odori
- Flacone da 250 ml (conf. 4 pz) o bottiglia da 1 L (conf. singola)

### Liquid fragrance for fragrance diffuser

- High quality propellant-free scent
- To be used with fragrance nebulizers and diffusers only
- Guarantees maximum fragrance's effectiveness
- Neutralizes bad smells
- Bottle of 250 ml (box of 4 pcs) or 1 L bottle (single)

250 ml



165 mm

50 mm



1 L



245 mm

78 mm



Explosion Parfume "Ocean Water" - 250 ml Explosion Parfume "Ocean Water" - 250 ml	<a href="#">86000527</a>
Explosion Parfume "Green Tea" - 250 ml Explosion Parfume "Green Tea" - 250 ml	<a href="#">86000627</a>
Explosion Parfume "Relax" - 250 ml Explosion Parfume "Relax" - 250 ml	<a href="#">86001527</a>

Explosion Parfume "Ocean Water" - 1 L Explosion Parfume "Ocean Water" - 1 L	<a href="#">86000523</a>
Explosion Parfume "Green Tea" - 1 L Explosion Parfume "Green Tea" - 1 L	<a href="#">86000623</a>
Explosion Parfume "Relax" - 1 L Explosion Parfume "Relax" - 1 L	<a href="#">86001523</a>

## EXPLOSION IGIENE AMBIENTE

250 ml

1 L



165 mm

50 mm



245 mm

78 mm



BALSAMICO MENTOLATO  
BALSAMIC MENTHOLATED

### Profumatore liquido con igienizzante per nebulizzatori automatici

- Profumatore con igienizzante e privo di propellenti
- Prodotto a base d'alcoli e sali d'ammonio quaternari
- Massima efficacia e persistenza
- Profuma, igienizza l'aria e neutralizza i cattivi odori
- Per grandi ambienti
- Flacone da 250 ml (Conf. 4 pz) o bottiglia da 1 L (conf. singola)

### Liquid perfumer with hygienizer for automatic nebulizer

- Perfumer, with hygienizer and propellants free
- Alcohol-based perfumer formula with quaternary ammonium salts
- Maximum fragrance's effectiveness and persistence
- Perfumes, cleans the air and neutralizes bad smells.
- For large environments
- 250 ml bottle (4 pack) or 1 L bottle (single pack)



Ricariche Explosion miste da 250 ml  
Explosion Mixed 250 ml refills

[86001727](#)

Explosion Igiene Ambiente - 250 ml Explosion Igiene Ambiente - 250 ml	<a href="#">86001627</a>
Explosion Igiene Ambiente - 1 L Explosion Igiene Ambiente - 1 L	<a href="#">86001623</a>



CONSIGLIAMO L'UTILIZZO DELLE PROFUMAZIONI EXPLOSION  
CON I DISPENSER DELLA LINEA EXPLOSION\*  
WE RECOMMEND THE USE OF EXPLOSION FRAGRANCES  
WITH EXPLOSION LINE DISPENSERS\*

\*Compatibili anche con gran parte dei diffusori presenti sul mercato  
\*Fit in most dispenser on the market





# MALÌA

## Ricariche spray per diffusori di profumo

- Fragranze per ambienti, intense e persistenti
- Elevata concentrazione della fragranza per una maggiore persistenza
- Efficace copertura in aree fino a 200 m<sup>3</sup>
- Conformi alle normative vigenti in tema di prodotti aerosol
- Bomboletta di profumo da 250 ml (2.500 spruzzi - conf. 12 pz)

## Spray air freshener refills

- Complex and long lasting fragrances
- High fragrance concentration leading a long-lasting scent effect
- Effective in room sizes up to 200 m<sup>3</sup>
- Fully compliant with aerosol legislation
- Cans include 250 ml of fragrance (2.500 sprays - box of 12 pcs)



Fragranze "Classic" con concentrazione  $\geq 1,2\%$   
"Classic" Scent concentration  $\geq 1,2\%$

Profumazione "Green Tea" "Green Tea" scent	<a href="#">797010</a>
Profumazione "Fior di Loto" "Lotus flower" scent	<a href="#">797011</a>
Profumazione "Mojito" "Mojito" scent	<a href="#">797012</a>
Profumazione "Orchidea Nera" "Black Orchid" scent	<a href="#">797013</a>
Profumazione "Talco" "Talc" scent	<a href="#">797014</a>
Profumazione "Vaniglia" "Vanilla" scent	<a href="#">797015</a>

Fragranze "Premium" con concentrazione  $\geq 2\%$   
"Premium" Scent concentration  $\geq 2\%$

<b>NEW</b> - Profumazione "Fior di caffè" <b>NEW</b> - "Coffee Flower" scent	<a href="#">797020</a>
<b>NEW</b> - Profumazione "Verbena" <b>NEW</b> - "Vervain" scent	<a href="#">797021</a>
Profumazioni miste "Classic" Mixed "Classic" scents	<a href="#">797019</a>
Profumazione PREMIUM "Brezza Marina" "Sea Breeze" PREMIUM scent	<a href="#">797016</a>
Profumazione PREMIUM "Vetiver" "Vetiver" PREMIUM scent	<a href="#">797017</a>

# MALÌA IGIENE AMBIENTE



## Igienizzante profumato per ambienti

- Igienizzante spray a base d'alcoli e sali d'ammonio quaternari
- Esercita un'azione igienizzante su tutte le superfici
- Profuma, igienizza l'aria e neutralizza i cattivi odori
- Bomboletta di profumo da 250 ml (2.500 spruzzi - conf. 12 pz)
- Pronto all'uso

## Perfumed hygienizer for environments

- Alcohol-based aerosol formula with quaternary ammonium salts
- It hygienizes all surfaces
- Perfumes and cleans the air, neutralizing bad smells
- Cans include 250 ml of fragrance (2.500 sprays - box of 12 pcs)
- Ready to use



Igienizzante profumato per ambienti  
Perfumed hygienizer for environments [797008](#)

CONSIGLIAMO L'UTILIZZO DELLE PROFUMAZIONI MALÌA CON I DISPENSER BASICA e SOFFIO\*  
WE RECOMMEND THE USE OF MALÌA FRAGRANCES WITH BASICA AND SOFFIO DISPENSERS\*

\*Compatibili anche con gran parte dei diffusori presenti sul mercato  
\*Fit in most dispenser on the market



## POSTAZIONI IGIENIZZANTI

### *SANITIZING STATIONS*







## TOTEM PRESS



1415 mm  
365 mm  
300 mm

### Postazione igienizzante a pedale

- Struttura in acciaio verniciato poliestere
- Alloggiamento regolabile per un flacone di soluzione liquida
- Vano dove riporre una confezione di kleenex, guanti o mascherine
- Funzionamento totalmente meccanico
- Erogazione della dose igienizzate mediante lieve pressione del pedale
- Massima igiene per l'utente, nessun contatto con le mani
- Pre-assemblato, comprensivo di sticker adesivi

### Foot-operated sanitizing station

- Hands-free station made from polyester coated steel
- Features an adjustable bottle tray with upper holder
- Compartment to storage a tissue, glove, mask box
- Fully mechanical pedal operation
- Slightly push the pedal down to get a sanitizing dose on the hands
- Ideal solution to reduce the risk of cross-contamination
- Pre-assembled, with stickers included



Postazione igienizzante a pedale - Nero  
*Pedal-operated sanitizing station - Black*

789151

Postazione igienizzante a pedale - Bianco  
*Pedal-operated sanitizing station - White*

789153

## TOTEM EVOLUTION



Piattino salvagoccia  
*Built-in plate*



Sistema telescopico  
*Telescopic system*



1350 mm  
450 mm  
520 mm

### Postazione igienizzante mobile

- Piantana autoportante in acciaio verniciato nero
- Predisposta per ospitare un dispenser automatico
- Piattino salvagoccia antivandalo incorporato
- Pannello espositivo personalizzabile
- Sistema telescopico per la regolazione dell'altezza
- Piedistallo a stella per la massima stabilità del prodotto
- Supporto per flacone (cod. 779051) in opzione
- Doppio vano contenitore per DPI (cod. 779056) in opzione
- Supporto pattumiera basculante (cod. 779057) in opzione

### Freestanding sanitizing station

- Freestanding station made from black coated steel
- Holds an automatic hand gel dispenser
- Vandal-proof build-in shield to protect the floor
- Comes with a header (14x14 cm) to apply visible signage
- Equipped with a telescopic system to adjust its height
- Star-shaped base for enhanced stability
- it can be used with a liquid hand soap holder (cod 779051) as option
- Double PPE compartment holder (cod 779056) as option
- Swing waste bin holder (cod 779057) as option



Postazione igienizzante mobile  
*Freestanding sanitizing station*

779052



## TOTEM EVOLUTION

### Accessori per postazione igienizzante mobile

- Supporti in acciaio verniciato nero
- Pattumiera in polipropilene nero

### Freestanding sanitizing station accessories

- Black coated steel
- Black polypropylene plastic bin



30 mm  
95 mm  
115 mm

**Supporto per flacone**  
Hand gel bottle holder



80 mm  
250 mm  
465 mm

**Doppio vano contenitore DPI**  
Double PPE compartment holder



148 mm  
65 mm  
187 mm

**Supporto per pattumiera basculante**  
Swing waste bin holder



500 mm  
290 mm  
360 mm

**Pattumiera basculante**  
Swing waste bin

Supporto per flacone igienizzante  
Hand gel bottle holder

779051

Doppio vano contenitore per DPI  
Double PPE compartment holder

779056

Supporto per pattumiera basculante 35 L  
Swing waste bin 35 L holder

779057

Pattumiera basculante 35 L  
Swing waste bin 35 L

909536

## TOTEM EVOLUTION



248 mm  
205 mm  
155 mm



### Supporto da banco per igienizzante mani

- Espositore da banco in acciaio verniciato nero
- Foro per flacone igienizzante con Ø collo 27 mm max.
- Piatto salvagoccia integrato

### Countertop hand sanitizer holder

- Black coated metal holder
- Top opening holds a diameter bottle 27 mm
- Built-in plate to keep the surrounding area clean

Supporto da banco per igienizzante mani  
Countertop hand sanitizer holder

779053



220 mm  
80 mm  
115 mm



### Supporto murale per igienizzante mani

- Supporto murale in acciaio verniciato nero
- Foro per flacone igienizzante con Ø collo 27 mm max.
- Viteria inclusa

### Wall-mount hand sanitizer holder

- Black coated metal holder
- Top opening holds a diameter bottle 27 mm
- Fixing kit included

Supporto murale per igienizzante mani  
Wall-mount hand sanitizer holder

779055



## TOTEM HIGGY

### Postazione igienizzante mobile

- Piantana autoportante in acciaio verniciato nero
- Predisposta per ospitare un dispenser automatico
- Supporto per flacone (cod. 779051) in opzione
- Vano contenitore di DPI (cod. 160751) in opzione
- Pannello espositivo personalizzabile (14x14 cm)
- Piattino salvagoccia antivandalo incorporato
- Sistema telescopico per regolarne l'altezza

### Freestanding sanitizing station

- Black coated steel freestanding station
- Holds an automatic hand gel dispenser
- As option, it can be used with a hand sanitizer holder (cod 779051)
- Multifunctional compartment to storage PPE (cod. 160751)
- Vandal-proof build-in shield to protect the floor
- Comes with a header (14x14 cm) to apply visible signage
- Equipped with a telescopic system to adjust its height



30 mm  
95 mm  
115 mm

Supporto per flacone  
Hand gel bottle holder



132 mm  
75 mm  
240 mm

Vano contenitore DPI  
PPE compartment holder



1400 mm  
318 mm  
318 mm

Postazione igienizzante mobile Freestanding sanitizing station	160750
Vano contenitore per DPI PPE compartment holder	160751
Supporto per flacone Hand gel bottle holder	779051

## NEBULA

0,7  
L



230 mm  
60/100 mm  
230 mm

### Nebulizzatore di liquido igienizzante

- Base e cover in ABS super resistente
- Tanica integrata a riempimento da 700 ml
- Per soluzioni idroalcoliche liquide
- Nebulizzazione automatica con sensore a infrarossi
- Tempo d'erogazione regolabile (4,5,7 o 9 sec.)
- Impostazione della quantità di liquido erogata (0,4/0,5/0,8/1,1 ml)
- Finestra per il controllo del livello del liquido
- Alimentatore a pile (4 AA x 1,5 V) non incluse
- D'appoggio, fissaggio su piantana o fissaggio murale (viteria inclusa)

### Alcohol liquid hand rub atomizer

- Heavy-duty ABS backing and cover
- Refillable tank 700 ml
- For alcohol-based liquid cleaner
- Automatic infrared sensor operated
- Adjustable dispensing time (4,5,7 or 9 sec.)
- Adjustable spray delivery (0,4/0,5/0,8/1,1 ml)
- Front viewing window to monitor liquid level
- AC Adapter or battery powered (4 AA x 1.5 V) not included
- Freestanding, post fixation, wall-mount installation (fixing kit included)



Nebulizzatore di liquido igienizzante 0,7 L Alcohol liquid hand rub atomizer 0,7 L	113000
Alimentatore per dispenser automatici NEBULA AC adapter for NEBULA automatic dispenser	104950



## COPRIFACILE KIT



420 mm  
120 mm  
131 mm

### Distributore kit DPI preconfezionati

- Base e cover in acciaio inox AISI 304 brillante
- Ospita kit monouso preconfezionati (circa 12 pz)
- Dimensioni max. della ricarica (LxP) 11x9 cm
- Finestra frontale per il controllo del consumabile
- Apertura superiore del coperchio per una facile ricarica
- Viteria e consumabile non inclusi

### Pre-packed PPE kit dispenser

- Backplate and cover from AISI 304 polished s.steel
- Holds pre-packed disposable kits (12 pcs)
- Suitable with refills max. dim. (LxD) 11x9 cm
- Front window to monitor consumable level
- Upper lid opening to facilitate the refill operation
- Fixing kit and consumable not included



Distributore kit DPI preconfezionati  
Pre-packed PPE kit dispenser

773024

## COPRIFACILE KIT



348 mm  
123 mm  
132 mm

### Distributore DPI sfusi

- Base e cover in acciaio inox AISI 304 brillante
- Ospita kit monouso sfusi (cuffie, maschere, copriscarpe, ecc.)
- Guarnizione in gomma per facilitarne l'estrazione
- Finestra frontale per il controllo del consumabile
- Coperchio apribile per una più rapida e pratica ricarica
- Viteria e consumabile non forniti

### Bulk disposable PPE dispenser

- Backplate and cover from AISI 304 polished s.steel
- Suitable for single-use clothing (caps, masks, shoe-covers, etc.)
- Plastic seal to facilitate the release
- Front window to monitor consumable level
- Upper lid opening to facilitate the refill operation
- Fixing kit and consumable not included



Distributore DPI monouso sfusi  
Bulk disposable PPE dispenser

773025



## COPRIFACILE KIT



### Distributore di cappelli monouso

- Struttura in acciaio inox AISI 304 brillante
- Ospita calotte monouso preconfezionate
- Ampio vano d'erogazione frontale
- Facile da ricaricare tramite il vano laterale
- Fissaggio murale
- Viteria e consumabile non forniti

### Paper forage hat dispenser

- Polished AISI 304 stainless steel case
- Suitable for single-use paper forage hats
- Wide front opening for easy hat release
- Quick refilling thanks to the lateral opening
- Wall-mounted installation
- Fixing kit and consumable not included

180 mm  
100 mm  
295 mm



Distributore di cappelli monouso  
Paper forage hat dispenser

773023

## BRINOX



### Distributore triplo di guanti monouso

- Acciaio inox AISI 304 brillante
- Contiene fino a 3 scatole di guanti
- Dim. max scatola (LxPxH): 24x6,5x11 cm
- Consente di disporre ordinatamente guanti di diverse taglie
- Fissaggio murale (viteria non inclusa)

### Triple dispenser of disposable gloves

- AISI 304 stainless steel, with polished finish
- Holds up to 3 glove boxes
- Max. box. dim. (LxDxH): 24x6,5x11 cm
- Allow easy access to many sizes of gloves
- Wall mount fastening (fixing hardware not included)



350 mm  
73 mm  
245 mm

Distributore triplo di guanti monouso  
Triple dispenser of disposable gloves

773021





## COPRIFACILE PRO 50



Ricarica  
Refill



190 mm  
520 mm  
230 mm

### Distributore automatico di copriscarpe

- Struttura in ABS bianco, con finiture blu
- Funzionamento meccanico, senza pile né elettricità
- Capienza fino a 50 copriscarpe
- Ricambi in PE (13 micron)

### Automatic shoe cover dispenser

- Sturdy white ABS case with blue finishes
- It mechanically dispenses shoe covers as you step into it
- Mechanic operation, no need for batteries nor electricity
- Capacity up to 50 shoe covers
- Refills in PE (13 micron)

	2 conf. x 50 calzari 2 packs x 50 covers
	205 x 115 mm 13 µm

Distributore copriscarpe ABS ABS shoe cover dispenser	110020
Ricarica copriscarpe in PE (13 micron) PE shoe cover refills (13 micron)	110071

## COPRIFACILE



140 mm  
430 mm  
220 mm



120 mm  
400 mm  
205 mm

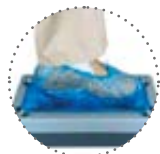

Ricarica PE - 110050  
PE refills - 110050

	5 conf. x 100 calzari 5 packs x 100 covers
	205 x 115 mm 8 µm

Ricarica TNT - 110053  
TNT refills - 110053

	4 conf. x 30 calzari 4 packs x 30 covers
	205 x 115 mm 24 g/m <sup>2</sup>

### Distributore automatico copriscarpe

- Alluminio o ABS
- Meccanico senza alimentazione elettrica
- Ricambi: standard PE, TNT

### Automatic shoe cover dispenser

- Aluminum or ABS casing
- It mechanically dispenses shoe covers as you step into it
- Support booties of different materials (PE or TNT shoe covers)
- Easy to load and clean

Distributore copriscarpe alluminio Aluminum shoe cover dispenser	110001
Distributore copriscarpe ABS ABS shoe cover dispenser	110006
Ricarica copriscarpe in PE (8 micron) PE shoe cover refills (8 micron)	110050
Ricarica copriscarpe in TNT Non-woven shoe cover refills	110053

## COPRIFACILE



### Copriscarpe monouso sfusi

- Copriscarpe usa e getta in polietilene (1,9 g)
- Idrorepellenti, igienici e protettivi
- Taglia unica con elastico per agevolare l'applicazione
- Ogni pacchetto contiene 100 calzari
- Ogni cartone contiene 40 pacchetti

### Bulk disposable shoe covers

- Disposable polyethylene shoe covers (1,9 g)
- Water-resistant, hygienic, and protective
- One-size-fits-all, with elastic for easy application
- Each pack includes 100 shoe covers
- Each carton includes 40 packs

	40 conf. x 100 calzari 40 packs x 100 covers
	375 x 145 mm 1,9 g

Copriscarpe monouso sfusi Bulk disposable shoe covers	130754
--	--------

# MATERIALI DI CONSUMO

## CONSUMABLES





## AIR HYGIENE

150  
ml



145 mm  
50 mm



Valvola one-shot  
One-shot trigger



Valvola one-shot  
Total release gun

### Igienizzante one-shot a rilascio totale

- Igienizzante spray a base d'alcoli e sali d'ammonio quaternari
- Contiene propellente leggero per una veloce saturazione degli ambienti
- Bombola auto-svuotante monouso da 150 ml
- Esercita un'azione igienizzante ad ampio spettro su tutte le superfici
- Purifica e rinfresca l'aria, neutralizzando i cattivi odori
- Trattamento rapido (15-20 min.) in ambienti chiusi da 60 m<sup>2</sup>/ 180 m<sup>3</sup>
- Applicazione professionale in vari tipi di settori e ambienti
- Indicato per il trattamento di uffici, ambulanze, studi medici, scuole

### One shot aerosol fogger

- Alcohol-based aerosol formulation with quaternary ammonium salts
- Disposable self-emptying can with total release trigger (150 ml)
- Ensures a deep cleaning action on all sort of surfaces
- Purifies and refreshes the air, by neutralizing bad smells
- Works in 15-20 minutes, it's effective in rooms up to 60 m<sup>2</sup>/180 m<sup>3</sup>
- Professional application in several types of environments
- Great for treating offices, ambulances, doctors' offices, schools, etc.



Air Hygiene 150 ml  
Air Hygiene 150 ml

797000

## PROHYGIENE DRY

400  
ml



200 mm  
65 mm



Valvola erogazione  
Spot spraying gun

### Igienizzante spray a secco

- Spray a base di alcoli e sali d'ammonio quaternari
- Contiene propellente pesante per una rapida caduta sulle superfici
- Ad azione igienizzante su tessuti e superfici non lavabili
- Formulazione a secco, non bagna e non unge
- Neutralizza gli odori lasciando un piacevole profumo di pulito
- Trattamento versatile, pronto all'uso, privo di gas inquinanti
- Funzionale anche per igienizzare gli impianti di AC e i loro filtri
- Applicazione consigliata sia in ambito domestico che in spazi pubblici

### Dry spray with deep cleaning action

- Multi-purpose cleaner containing alcohol and quaternary ammonium salts
- Can be used on a variety of surfaces and fabrics
- Dry formulation, it does not wet or grease
- Deep deodorization action, ideal to neutralize bad smells
- Effective, quick and ready-to-use
- Professional application in several types of environments
- Suitable in offices, waiting rooms, domestic environments, bus cabins, etc.



ProHygiene Dry 400 ml  
ProHygiene Dry 400 ml

797001



## ECO SOAP LC

5 L



250 mm  
190 mm  
160 mm

### Sapone liquido per le mani

- Deterge delicatamente le mani, lasciando morbida la cute
- Piacevolmente profumato e delicato; disponibile in colore rosa o bianco
- Utilizzare con pompetta manuale o dispenser di sapone
- Tanica da 5 L (confezione da 4 taniche)
- Conforme ai protocolli HACCP

### Liquid hand soap

- Gently cleans the hands, by leaving the skin soft
- Pleasant talc scent on skin; available in pink or white version
- To be used with manual pump or soap dispenser
- 5 L tank (sold 4-pack)
- In accordance with HACCP protocols



Sapone liquido le per mani - 5 L  
*Liquid hand soap - 5 L*

85000330

Sapone liquido le per mani "WHITE" - 5 L  
*Liquid hand soap "WHITE" - 5 L*

85000430

## ECOSOAP

1 L

5 L



250 mm  
85 mm

250 mm  
190 mm  
160 mm

### Sapone liquido con antibatterico per le mani

- Deterge delicatamente le mani, lasciando morbida la cute
- Preserva l'equilibrio idro-lipidico conferendo un piacevole profumo
- Formula cosmetica, con antibatterico; conforme ai protocolli HACCP
- Ecologico, non contiene tensioattivi anionici / SLES
- Flacone da 1 L (conf. 9 pezzi) o tanica da 5 L (confezione da 4 taniche)

### Liquid hand soap with antibacterial

- Gently cleans and sanitizes the hands, by leaving the skin soft
- Preserves the hydrolipidic skin balance and gives a pleasant flower scent
- Professional formula, with antibacterial; compliant with HACCP protocols
- Ecological, does not contain anionic surfactants / SLES
- 1 L bottle (9 units/box) or 5 L tank (sold 4-pack)



Sapone liquido con antibatterico per mani - 1 L  
*Liquid hand soap with antibacterial - 1 L*

85000123

Sapone liquido con antibatterico per mani - 5 L  
*Liquid hand soap with antibacterial - 5 L*

85000130

## ECOFOAM

1 L



250 mm  
85 mm

### Sapone a schiuma con antibatterico per le mani

- Soluzione lavamani a schiuma pronta all'uso con pH neutro
- Deterge e igienizza delicatamente le mani, lasciando morbida la cute
- Preserva l'equilibrio idro-lipidico conferendo un piacevole profumo
- Formula cosmetica, con antibatterico; conforme ai protocolli HACCP
- Ecologico, non contiene tensioattivi anionici / SLES
- Flacone da 1 L venduto in confezione da 9 pezzi

### Foam soap with with antibacterial

- Ready-to-use pH-neutral foam hand wash solution
- Preserves the hydrolipidic skin balance and gives a pleasant flower scent
- Professional formula, with antibacterial; compliant with HACCP protocols
- Ecological, does not contain anionic surfactants / SLES
- 1 L bottle (9 units per box) or 5 L tank (sold singly)



Sapone a schiuma con antibatterico per mani 1 L  
*Foam hand soap with antibacterial 1 L*

85000223





## SACCHETTI



280 mm  
50 mm  
120 mm

### Sacchetti igienici in carta

- Sacchetto igienico per signora in carta
- Dimensioni: 12x28 cm
- 200 sacchetti per confezione
- 10 confezioni per cartone

### Paper sanitary towel bag

- Paper bags for sanitary towels
- Size: 12x28 cm
- 200 bags per package
- 10 packets per carton



Sacchetti igienici in carta  
Paper sanitary towel bag

99096

## SACCHETTI



124 mm  
11 mm  
87 mm

### Sacchetti igienici in plastica

- Sacchetto igienico bianco per signora in HDPE
- 25 sacchetti per confezione
- 48 confezioni per cartone (= 1200 sacchetti)

### Plastic sanitary towel bag

- White HDPE plastic bag for sanitary towels
- 25 bags per package
- 48 packages per carton (= 1200 bags)

Sacchetti igienici in plastica  
Plastic sanitary towel bag

799002

## CARTA



255 mm  
35 mm  
195 mm

### Carta copriwater biodegradabile

- Carta biodegradabile da 14 gr o 18 gr
- Confezione da 200 fogli
- Stabilità e resistenza

### Toilet seat cover

- Biodegradable toilet seat cover paper (14 gr or 18 gr)
- 200 sheets per pack
- High-quality

Carta copriwater 14 gr  
Toilet seat cover 14 gr  
Carta copriwater 18 gr  
Toilet seat cover 18 gr

109114

109118



KIT DI PRIMO SOCCORSO

*FIRST AID KITS*





## METAL PHARMA UNO



450 mm  
150 mm  
360 mm

### Armadio farmacia 1 porta

- Struttura in acciaio verniciato con polvere epossidica
- Due ripiani interni fissi in metallo
- Serratura in metallo
- Pacco medicazione non incluso

### First aid wall cabinet (1 door)

- Powder epoxy coated steel body
- Two fixed shelves
- Metal keyed lock
- First aid supplies not included



Metal Pharma 1 porta  
Metal Pharma 1 door

107001

## METAL PHARMA DUE



540 mm  
200 mm  
520 mm

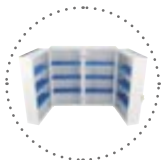

### Armadio farmacia 2 porte

- Struttura in acciaio verniciato con polvere epossidica
- 12 ripiani interni fissi in acciaio
- Serratura in metallo
- Molto capiente
- Pacco medicazione non incluso

### First aid wall cabinet 2 doors

- Powder epoxy coated steel body
- Twelve fixed coated steel shelves
- Metal keyed lock
- First aid supplies not included



Metal Pharma 2 porte  
Metal Pharma 2 doors

107002

## PLASTIC PHARMA



400 mm  
127 mm  
275 mm

### Armadio farmacia 1 porta

- Plastica RC colore bianco
- 3 vani, 2 ripiani interni e chiusura a scatto
- Pacco medicazione non incluso

### First aid wall cabinet

- RC plastic / white coloured
- 3 spaces, 2 shelves, snap lock
- First aid supplies not included



Plastic Pharma 1 porta  
Plastic Pharma 1 door

709011



340 mm  
120 mm  
225 mm



### Armadio farmacia compreso di allegato 2

- Armadietto in polipropilene, adatto per qualsiasi settore
- Pacco medicazione fino a due lavoratori incluso

### First aid wall cabinet + first aid kit #2

- Polypropylene cabinet, suitable for any area
- First aid kit #2 included



Plastic Pharma + Pacco medicazione  
Plastic Pharma + First aid kit #2

702517



## VALIGIA



270 mm  
135 mm  
395 mm

### Valigia di primo soccorso

- Valigia in polipropilene
- Maniglia per un facile trasporto
- Supporto murale incluso
- Pacco medicazione non incluso

### Plastic box for first aid kit

- Sealable polypropylene case
- Handle hanger for easy handling
- Wall bracket included
- First aid supplies not included



190 mm  
90 mm  
250 mm



Supporto murale  
Wall bracket

Varianti colore / Colors available



Valigia bianca piccola Small white box	709013
Valigia bianca grande Big white box	709012
Valigia arancione grande Big orange box	709014

## PLASTIC PHARMA



x 2

209 mm  
97 mm  
309 mm

### Valigia compresa di pacco medicazione (allegato 2)

- Valigia pensile in polipropilene
- Supporto a muro in materiale plastico molto resistente
- Ideale per essere posizionata su veicoli aziendali
- Pacco medicazione (allegato 2) incluso

### Small plastic box + first aid kit #2

- Ergonomic polypropylene case with gasket
- Sturdy wall bracket included
- Convenient size great for any kind of travel
- First aid kit #2 included

Valigia + P.M. fino a 2 lavoratori Case + First aid kit #2	702518
---	--------



x 3+

300 mm  
114 mm  
405 mm

### Valigia compresa di pacco medicazione (allegato 1)

- Valigia pensile in polipropilene, ergonomica e robusta
- Dotata di speciali chiusure di sicurezza
- Divisori interni in plastica per una migliore sistemazione dei prodotti
- Robusto supporto a muro in polipropilene
- Ideale per essere posizionata anche su veicoli aziendali
- Pacco medicazione (allegato 1) incluso

### Large plastic box + first aid kit #1

- Ergonomic polypropylene case with gasket
- Handle hanger for easy handling
- Sturdy wall bracket included
- Convenient size great for any kind of travel
- First aid kit #1 included

Valigia + P.M. 3 o più lavoratori Case + First aid kit #1	702519
--	--------



## PACCO MEDICAZIONE

### Pacco medicazione

- Pacchi medicazione a norma del D.M. 388 15/07/2003 e del D.L. 81 9/04/2008
- Pacco allegato 2 - fino a due lavoratori
- Pacco allegato 1 - per tre o più lavoratori
- Pacco reintegro allegato 1 senza sfigmomanometro D.M. 388 15/07/03 allegato 1 e D.L. 81 del 09/04/08

### First aid kits

- First aid kit #2 - First aid supplies for up to 2 people
- First aid kit #1 - First aid supplies for more than 3 people
- Refill for first aid kit #1 - Without blood pressure meter



Fino a 2 lavoratori Up to 2 people	702590
3 o più lavoratori 3 or more people	702589
Ricambio Refills	702591



Fino a 2 lavoratori Up to 2 people	PM090
3 o più lavoratori 3 or more people	PM089
Ricambio Refills	PM091

## Elenco articoli contenuti nei pacchi medicazione / List of items contained in the box

### Contenuto minimo Allegato 1

Guanti sterili monouso - Q.tà 5 paia. Flacone di soluzione cutanea di iodopovidone (10% di iodio) 500 ml - Q.tà 2. Flacone di soluzione fisiologica (sodio cloruro 0,9%) da 500 ml - Q.tà 3. Compresse di garza sterile 10x10 cm in buste singole - Q.tà 10. Compresse di garza sterile 18x40 in buste singole - Q.tà 2. Pinzette da medicazione sterili monouso - Q.tà 2. Confezione di cotone idrofilo - Q.tà 1. Confezione di cerotti di varie misure pronti all'uso - Q.tà 2. Rotoli di cerotto alto 2,5 cm - Q.tà 2. Visiera paraschizzi - Q.tà 1. Forbici - Q.tà 1. Lacci emostatici - Q.tà 3. Ghiaccio pronto uso - Q.tà 2. Teli sterili mono uso - Q.tà 2. Confezione di rete elastica di misura media - Q.tà 1. Termometro digitale - Q.tà 1. Apparecchio per la misurazione della pressione arteriosa - Q.tà 1. Istruzioni sul modo di usare i presidi e prestare i primi soccorsi.

### Contenuto minimo Allegato 2

Guanti sterili mono uso - Q.tà 2 paia. Flacone di soluzione cutanea di iodopovidone (10% di iodio) - 125 ml - Q.tà 1. Flacone di soluzione fisiologica (sodio cloruro 0,9%) da 250 ml - Q.tà 1. Compresse di garza sterile 10x10 cm in buste singole - Q.tà 3. Compresse di garza sterile 18x40 in buste singole - Q.tà 1. Pinzette da medicazione sterili mono uso - Q.tà 1. Confezione di cotone idrofilo - Q.tà 1. Confezione di cerotti di varie misure pronti all'uso - Q.tà 1. Rotoli di cerotto alto 2,5 cm - Q.tà 1. Forbici - Q.tà 1. Laccio emostatico - Q.tà 1. Ghiaccio pronto uso - Q.tà 1. Sacchetti mono uso per la raccolta di rifiuti sanitari - Q.tà 1. Rotolo benda orlata - Q.tà 1. Istruzioni sul modo di usare i presidi e prestare i primi soccorsi.

### Contenuto pacco reintegro Allegato 1 Senza Sfigmomanometro

Guanti sterili mono uso - Q.tà 5 paia. Flacone di soluzione cutanea di iodopovidone (10% di iodio) 500 ml - Q.tà 2. Flacone di soluzione fisiologica (sodio cloruro 0,9%) da 500 ml - Q.tà 3. Compresse di garza sterile 10x10 cm in buste singole - Q.tà 10. Compresse di garza sterile 18x40 cm in buste singole - Q.tà 2. Pinzette da medicazione sterili mono uso - Q.tà 2. Confezione di cotone idrofilo - Q.tà 1. Confezione di cerotti di varie misure pronti all'uso - Q.tà 2. Rotoli di cerotto alto 2,5 cm - Q.tà 2. Visiera paraschizzi - Q.tà 1. Forbici - Q.tà 1. Lacci emostatici - Q.tà 3. Ghiaccio pronto uso - Q.tà 2. Sacchetti mono uso per la raccolta di rifiuti sanitari - Q.tà 2. Teli sterili mono uso - Q.tà 2. Confezione di rete elastica di misura media - Q.tà 1. Termometro digitale - Q.tà 1. Istruzioni sul modo di usare i presidi e prestare i primi soccorsi.

### First aid kit #1

5 pairs of disposable sterile gloves - 1 bottle of povidone skin solution bottle (10% iodine) 500 ml - 3 bottles of physiological solution bottle (0,9% sodium) 500 ml - 3 pcs of sterile pads (10x10 cm) in single packs - 10 pcs of sterile pads (18x40 cm) in single packs - 2 pcs of disposable sterile forceps - 2 packs of absorbent cotton - 1 box of ready-to-use adhesive bandages (available in different sizes) - 2 pcs of plaster roll (2,5 cm width) - 2 pc of protection visor - 1 pair of scissors - 1 pc of tourniquet - 3 pcs of ready-to-use ice - 2 pcs of disposable and sterile sheets - 2 pcs of elastic net - 1 pc of digital thermometer - 1 pc of blood pressure meter - 1 pc of first aid facts guide.

### First aid kit #2

2 pairs of disposable sterile gloves - 1 bottle of povidone skin solution bottle (10% iodine) 125 ml - 1 bottle of physiological solution bottle (0,9% sodium) 500 ml - 1 pc of sterile pads (10x10 cm) in single packs - 3 pcs of sterile pads (18x40 cm) in single packs - 1 pc of disposable sterile forceps - 1 packs of absorbent cotton - 1 box of ready-to-use adhesive bandages (available in different sizes) - 1 pc of plaster roll (2,5 cm width) - 1 pair of scissors - 1 pc of tourniquet - 1 pc of ready-to-use ice - 1 pc of disposable sanitary bag - 1 pc of disposable and sterile sheets - 1 pc of first aid facts guide.

### List of items contained in the box

5 pairs of disposable sterile gloves - 1 bottle of povidone skin solution bottle (10% iodine) 500 ml - 2 bottles of physiological solution bottle (0,9% sodium) 500 ml - 3 pcs of sterile pads (10x10 cm) in single packs - 10 pcs of sterile pads (18x40 cm) in single packs - 2 pcs of disposable sterile forceps - 2 packs of absorbent cotton - 1 box of ready-to-use adhesive bandages (available in different sizes) - 2 pcs of plaster roll (2,5 cm width) - 2 pc of protection visor - 1 pair of scissors - 1 pc of tourniquet - 3 pcs of ready-to-use ice - 1 pc of disposable sanitary bag - 2 pcs of elastic net - 1 pc of digital thermometer - 1 pc of first aid facts guide.

ASCIUGAMANI ELETTRICI

*HAND DRYERS*







# Asciugamani Elettrici

# Hand Dryers

## Guida alla scelta

Gli asciugamani elettrici trovano ampia applicazione nelle toilette dei locali pubblici quale valida alternativa ai tradizionali sistemi d'asciugatura. Se le potenzialità di questi dispositivi sono ormai note, meno semplice risulta invece orientarsi verso l'acquisto del prodotto che meglio risponde alle esigenze del contesto in cui verrà installato. Gli asciugamani elettrici si differenziano infatti sotto il profilo tecnico, funzionale ed estetico, motivo per il quale non potrà mai esistere l'asciugamani "perfetto", quanto piuttosto quello con le caratteristiche migliori rispetto all'ambiente d'utilizzo.

Sei sono i **criteri** su cui basarsi quando si desidera acquistare un asciugamani elettrico:

- 1 **l'affluenza degli utilizzatori** nel locale bagno, stimabile in termini di frequenza degli utilizzi giornalieri, ma anche come concentrazione delle attivazioni del dispositivo nel medesimo nell'arco della giornata.
- 2 **budget di spesa**, include il prezzo d'acquisto della macchina ma anche i costi d'esercizio dovuti alla manutenzione e ai consumi elettrici.
- 3 **le performance** del dryer intesa come velocità d'asciugatura e silenziosità.
- 4 eventuali rischi di **vandalismo**.
- 5 **l'ottemperanza agli standard igienici**.
- 6 aspetti legati al **design**.

## Selection guide

Hand dryers have become more and more popular in public restrooms as a valid alternative to conventional drying systems. Although the implementation of these devices is shown to be a viable and effective solution in many environments, it may be quite hard to choose the product which best fits the facility's needs. The reason for this lies in the fact that there are many types of hand dryers available on the market and they differ from one another in terms of technical, functional and aesthetic features. Thus, you will never find the perfect hand dryer for a given context of use, but the one which best meets the requirements for the job.

There are **six factors** to be considered while choosing a hand dryer:

- 1 **the flow of people** using the public restroom, estimated in terms of daily frequency of use and concentration of device activation throughout the day.
- 2 **budget**, in which you have to include the device purchase price as well as the operating costs due to maintenance and power consumption.
- 3 **hand dryer's performance**, in terms of drying speed and quietness
- 4 possible **risks of vandalism**.
- 5 **compliance with hygiene standards**
- 6 aspects related to **design**.

	Aree ad elevato traffico High traffic areas	Aree a medio traffico Medium traffic areas	Aree a basso traffico Low traffic areas
Asciugamani Jet Jet dryers	 Twister	 Zefiro	 Mini Zefiro
Asciugamani Smart Smart dryers	 Kari X-Dry X-Dry Compact Bayamo	 Mocka Dry Max UV Zefiro Pro UV Zefiro Hot	
Asciugamani tradizionali Traditional hand dryers		 Hamet Arielimp	 Qibli Alisé

Per meglio rispondere alle esigenze di ambienti e fasce d'utenza molto diverse tra loro, Medial International ha completato la propria offerta d'accessori bagno con ben tre gamme di asciugamani elettrici.

I **jet dryers** sfruttano la sofisticata tecnologia dei motori di nuova generazione, che sprigionano getti d'aria ad altissima velocità. Caratteristica fondamentale di questa categoria è la velocità d'asciugatura abbinata al risparmio energetico.

Gli **smart jet dryers** combinano il principio d'asciugatura a propulsione dei jet dryers con il medesimo comfort d'utilizzo dei tradizionali asciugamani ad aria calda.

Gli **asciugamani tradizionali** incorporano una resistenza elettrica che riscalda il flusso d'aria in uscita in modo immediato e costante. Sono soluzioni ideali per chi predilige la tradizione all'innovazione.

To better meet the needs of different user segments and environments, Medial International has completed its bathroom accessories offer with two ranges of hand dryers.

**Jet hand dryers** take advantage of advanced motor technology, capable of circulating air at very high speed and so eliminating the water on the hands quickly. The main features of this range are high drying speed and considerable energy saving.

**Smart jet hand dryers** combine the high-powered jets of air to rapidly blow water off the hands with drying comfort of traditional dryers, using a heating element to warm air.

**Traditional hand dryers:** are equipped with a heating element, which immediately and constantly warms up the air while passing through it. These are ideal solutions for those who prefer tradition to innovation.



## Tabelle comparativa

## Comparative chart

	Potenza totale Rated power	Resistenza Rated power	Temperatura aria Rated power	Silenziosità Rated power	Filtri aria Rated power	Velocità asciugatura Rated power
Twister	1.750 W	x		80 dB	EPA E11 (su richiesta / on request)	12 - 15 sec.
Kari	1.450 W (AC) 1.300 W (B-less)	ON-OFF 550 W		78 dB	EPA E11 (di serie / standard)	5 - 10 sec.
X-Dry	1.800 W (B-less)	ON-OFF 600 W (B-less)		75 dB	EPA E11 (di serie / standard)	12 - 15 sec.
X-Dry Compact	1.450 W	ON-OFF 350 W		75 dB	EPA E11 (di serie / standard)	12 - 15 sec.
Bayamo	1.900 W	ON-OFF 1.000 W		72 dB	FILTRO ARIA / AIR FILTER (di serie / standard) EPA E11 (in opzione / optional)	10 - 12 sec.
Mocka	1.350 W	ON-OFF 800 W		72 dB	FILTRO ARIA / AIR FILTER (di serie / standard)	12 - 15 sec.
Dry Max UV	450 - 1.000 W	ON-OFF 225 - 500 W		68-75 dB	EPA E11 (di serie / standard)	15 sec.
Zefiro Pro UV	1.100 W	ON-OFF 550 W		75 dB	EPA E11 (di serie / standard)	12 - 15 sec.
Zefiro	1.100 W	x		80 dB	EPA E11 (in opzione / optional)	15 sec.
Zefiro Hot	1.100 W	550 W		75 dB	EPA E11 (in opzione / optional)	15 sec.
Mini Zefiro	900 W	500 W		70 dB	EPA E11 (in opzione / optional)	20 sec.
Hamet	2.400 W	2.200 W		70 dB	x	35 sec.
Arielimp	2.500 W	2.250 W		70 dB	x	35 sec.
Qibli	1.850 W	1.785 W		60 dB	x	50 sec.
Alisé	1.800 W	1.700 W		54 dB	x	50 sec.

### Manutenzione:

La **scocca dell'asciugamano elettrico** dev'essere periodicamente pulita utilizzando un detergente non aggressivo e comunque idoneo al tipo di materiale da trattare.

La **bacinella di recupero dell'acqua**, ove presente, dev'essere svuotata con regolarità settimanale onde evitarne l'eccessivo riempimento.

Per i dryer con motori a spazzola, è necessario sostituire i **carboncini** ogni 1.000 ore di funzionamento onde evitare danni al motore.

Il **filtro dell'aria**, ove presente, dev'essere pulito con acqua periodicamente. Il **filtro EPA E11** non è lavabile: se ne consiglia la sostituzione almeno una volta all'anno.

Per l'applicazione e le limitazioni di garanzia, consultare le condizioni post-vendita.

### Maintainance:

The **cover must be cleaned regularly** by using a mild detergent, water and a damp cloth. We recommend you choose the cleaning solution depending on the type of material to be treated.

The **drain tank**, where provided, must be emptied on a weekly basis to avoid water overflows and to prevent mold and unpleasant smells from spreading. As for dryers with **brush motors**, these must be replaced from time to time (on average every 1.000 hours of use) to avoid damage to motor.

The **air filter**, where provided, must be regularly cleaned with water. As for **EPA E11 filter**, it is not washable, so it must be replaced at least once a year.

As for warranty application and limitations, please consult after-sales conditions



## TWISTER



Prestazioni eccellenti e massima efficienza sono le due caratteristiche che fanno di Twister l'asciugamani ideale per le aree ad elevato traffico d'utenza. Il dryer sfrutta un flusso ad altissima velocità che asciuga le mani in pochi istanti. Essendo privo di resistenza, l'aria si intiepidisce al surriscaldarsi dei motori. Il design, semplice ma ergonomico, propone un'asciugatura delle mani tramite inserimento verticale.

Outstanding performance and high-efficiency make Twister the ideal choice for high traffic toilets. Designed with super speedy heater-free technology, this model uses high-powered jets of air to quickly blow water off the hands. Available in silver or white finishes, Twister features a "hands-in" vertical drying style in line with current trends.



**DESIGN ERGONOMICO** - Massimo comfort d'utilizzo per l'utente grazie alla doppia lama d'asciugatura e all'ampio vano d'inserimento delle mani, reso più accessibile dalle due aperture laterali.

**ERGONOMIC DESIGN** - Twister features a wide hand drying area, opened on both sides, and a double wave-shape nozzles. This makes the dryer more comfortable and easier to use.



**DOPPIO MOTORE, MASSIME PRESTAZIONI** - Grazie a due motori a spazzola, che operano simultaneamente con una potenza complessiva di 1750 W, Twister assicura un'asciugatura ottimale e rapida in 12-15 secondi.

**DOUBLE MOTOR, OUTSTANDING PERFORMANCE** - Twister is operated by two brush motors which work simultaneously to reach a rated power of 1750 W. The dryer boasts a quick drying time of 12-15 seconds.



**SISTEMA DROP-STOP** - La cover del dryer include un sistema di ritenuta laterale dell'acqua che ne previene il gocciolamento al suolo, garantendo massima igiene e pavimenti sempre asciutti.

**DROP-STOP SYSTEM** - The special cover shape with side bars prevents water from dripping on the floor and minimizes splashes. This helps keep restrooms always clean and tidy.



**SERBATOIODISCARICO** - Il dryer incorpora una vaschetta di recupero che cattura l'acqua derivante dal processo d'asciugatura. Il serbatoio è estraibile, facile da svuotare e pulire, per prevenire la formazione di muffe e cattivi odori.

**DRAIN TANK** - The unit incorporates a built-in drain tank that catches water droplets coming off users' hands. Being removable, the tank can be easily empty and clean, to avoid overflows, mold and bad smells.

### Caratteristiche elettriche / Electrical specifications

Numero motori / Number of motors	2
Tipo motore / Motor type	Motore AC a spazzole / Ac brush motor
Potenza totale / Total power	1.750 W
Potenza motore / Motor power	2 x 875 W
Potenza resistenza Heating element power	Nessuna resistenza No heater
Voltaggio / Voltage	220-240 V
Frequenza / Frequency	50-60 Hz
Isolamento elettrico Electrical isolation	Classe II Class II
Grado di protezione elettrica Electrical class protection	IP31

### Struttura / Construction

Scocca / Casing	ABS / ABS
Dimensioni (LxPxH) Dimensions (WxDxH)	300x230x650 mm
Peso / Weight	9,5 kg

### Funzionamento / Operation

Attivazione / Activation	Automatico (sensori a infrarossi) Automatic infrared detector
Velocità dell'aria / Air speed	410 Km/h (in uscita / output)
Volume d'aria / Air flow	2 x 150 m³/h
Rumorosità (da 1 M) Noise level (@ 1 M)	80 dB
Velocità asciugatura / Drying time	12-15 sec.

### Accreditamento / Accreditations

Marchi di qualità / Quality marks	CE, RoHS
-----------------------------------	----------

### Codici prodotto / Product code

Bianco / White	<b>704200</b>
Grigio metallizzato / Satin-grey	<b>704202</b>



KARİ



Grazie al suo concept innovativo, Karı rivoluziona ed arricchisce ulteriormente la gamma di asciugamani elettrici. Ideale nelle aree ad elevato traffico d'utenza, questo nuovo smart jet dryer offre un'esperienza d'asciugatura super rapida, facilitata dall'apertura frontale. Le mani vengono asciugate orizzontalmente da una lama d'aria circolare ultra performante. Il prodotto è disponibile nella versione "Easy", con motore a spazzole, e nella versione "Pro", con motore brushless.

Thanks to its revolutionary and innovative design, Karı enriches and extends our range of electric hand dryers further. Ideal in high traffic areas, this new smart jet dryer offers an ultra fast drying experience (5-10 seconds), facilitated by the horizontal frontal opening. The product is available in the "Easy" version, with AC motor, and in the "Pro" version, with brushless motor.

Caratteristiche elettriche / Electrical specifications	
Numero motori / Number of motors	1
Tipo motore / Motor type	EASY - Motore AC a spazzole / AC brush motor PRO - Motore brushless / Brushless motor
Potenza totale / Total power	1.050 W - 1.450 W (EASY) 1.000 W - 1.300 W (PRO)
Potenza motore / Motor power	550 W
Potenza resistenza / Heating element power	900 W (EASY) 450 W - 750 W (PRO)
Voltaggio / Voltage	220-240 V
Frequenza / Frequency	50-60 Hz
Isolamento elettrico / Electrical isolation	Classe I Class I
Grado di protezione elettrica / Electrical class protection	IPX4
Struttura / Construction	
Scocca / Casing	ABS ABS
Filtro EPA E11 / EPA E11 Filter	Di serie / Standard
Dimensioni (LxPxH) / Dimensions (WxDxH)	318x185x615 mm
Peso / Weight	9,6 Kg
Funzionamento / Operation	
Attivazione / Activation	Automatico (sensori a infrarossi) Automatic infrared detector
Velocità dell'aria / Air speed	EASY - 324 - 486 Km/h PRO - 270 - 396 Km/h
Volume d'aria / Air flow	89-124 m³/h
Rumorosità (da 1 M) / Noise level (@ 1 M)	78 dB
Velocità asciugatura / Drying time	5 - 10 sec.
Accreditamento / Accreditations	
Marchi di qualità / Quality marks	CE, RoHS
Codici prodotto / Product code	
<b>Versione "Easy" / "Easy" version</b>	
Bianco / White	<b>160020</b>
Grigio metallizzato / Satin-grey	<b>160022</b>
<b>Versione "Pro" / "Pro" version</b>	
Bianco / White	<b>160025</b>
Grigio metallizzato / Satin-grey	<b>160027</b>
<b>Accessori &amp; ricambi / Accessories &amp; spare parts</b>	
Filtro EPA E11 / EPA E11 filter	<b>160965</b>



**AC o BRUSHLESS** - La versione "Easy" è fornita con motore a corrente alternata, per un miglior rapporto qualità-prezzo. La versione "Pro" include un motore brushless, con prestazioni eccellenti ed una minor usura nel tempo.

**AC or BRUSHLESS** - The "Easy" version is supplied with an AC current motor, for a better quality-price ratio. The "Pro" version includes a brushless motor, which guarantees excellent performance and less wear over time.



**ASCIUGATURA A 360°** - Il dryer è dotato di un ampio vano d'asciugatura circolare. Il flusso d'aria viene erogato a 360°, consentendo una asciugatura ultra rapida in pochi secondi.

**360° CIRCULAR DRYING ZONE** - The dryer is equipped with a large circular drying compartment. The air flow is delivered at 360°, allowing an ultra fast drying in a few seconds.



**PANNELLO DI REGOLAZIONE INTEGRATO** - Specifici selettori consentono di attivare o disattivare la resistenza (ON/OFF); regolare la potenza del motore scegliendo tra tre velocità dell'aria (Low, Medium, High).

**INTEGRATED ADJUSTMENT PANEL** - Specific selectors allow you to activate or deactivate the heater (ON / OFF); adjust the motor power by choosing between three air speeds (Low, Medium, High).



**CERAMICA ASSORBENTE** - Il vano d'asciugatura è corredato da una piastra ceramica in grado di assorbire fino a 70 g di acqua e sopportare circa 280 giri completi d'asciugatura al giorno.

**ABSORBENT CERAMICS** - The drying compartment is equipped with a ceramic plate that can absorb up to 70 g of water and withstand about 280 complete drying cycles per day.



**FILTRO EPA (DI SERIE)** - L'unità è equipaggiata di serie con filtro EPA E11, che purifica l'aria in fase d'aspirazione eliminando fino al 97,66% delle microparticelle di polvere e batteri presenti nell'aria utilizzata per l'asciugatura.

**EPA FILTER (STANDARD)** - The appliance is equipped as standard with an EPA E11 filter, which guarantees protection against 97.66% of bacteria present in the air used during drying.



## X-DRY



X-Dry è uno smart dryer di nuova concezione, studiato per toilette a medio-alta affluenza. Disponibile con motore brushless, sfrutta il principio d'asciugatura a propulsione dei jet dryers, pur incorporando un elemento riscaldante funzionale ad intiepidire istantaneamente il flusso d'aria.

X-Dry is a next generation smart dryer designed for medium-high traffic toilets. Available with brushless motor, the product boasts excellent drying performance, using high-powered jets of air to rapidly blow water off the hands. X-dry also incorporates a heating element capable of warming the air stream instantaneously.



**MOTORE BRUSHLESS** - X-DRY PRO include un motore brushless, che garantisce prestazioni eccellenti ed una minor usura nel tempo.  
**BRUSHLESS MOTOR** - X-Dry Pro incorporates a brushless motor for higher performance, less maintenance and top energy saving.



**REGOLAZIONE ARIA CALDA/FREDDA** - La temperatura dell'aria è regolabile manualmente con pulsante ON/OFF, per ottimizzare i consumi durante la stagione estiva e migliorare il comfort d'asciugatura nel periodo invernale.

**ADJUSTABLE HEAT CONTROL** - To offer higher efficiency and greater comfort in use, the heater can be activated or deactivated according to preferences. The ON/OFF button is located at the bottom of the unit.



**PROTEZIONE TERMICA** - X-Dry è dotato di un sensore in grado di disattivare automaticamente la resistenza elettrica quando la temperatura del flusso d'aria raggiunge i 30° C.

**OVERHEATING PROTECTION** - X-Dry has an in-built sensor system capable of deactivating the heating element when the air heat output reaches 30°.



**SERBATOIO DI SCARICO** - Il dryer incorpora una vaschetta di recupero con funzione "troppopieno" che cattura l'acqua d'asciugatura. Il serbatoio è estraibile, facile da svuotare e da pulire per evitare la formazione di muffe e cattivi odori.

**DRAIN TANK** - The unit incorporates a drain tank with overflow pump that catches water droplets coming off users' hands. Being removable, the tank can be easily emptied and clean to both avoid overflows and bad smells.



**DOPPIO FILTRO EPA (DI SERIE)** - X-Dry include di serie un doppio filtro EPA E11, che purifica l'aria in fase d'aspirazione eliminando fino al 97,66% delle microparticelle presenti prima del processo d'asciugatura.

**DOUBLE EPA FILTER (AS STANDARD)** - X-Dry comes as standard with two EPA E11 filter, which purify the air by trapping up to 97,66% of dust micro-particles, pollen and bacteria suspended in the incoming air flow.

### Caratteristiche elettriche / Electrical specifications

Numero motori / Number of motors	1
Tipo motore / Motor type	PRO - Digitale brushless / Digital Brushless
Potenza totale / Total power	1.800 W
Potenza motore / Motor power	1.200 W (BRUSHLESS)
Potenza resistenza Heating element power	600 W (BRUSHLESS)
Voltaggio / Voltage	220-240 V
Frequenza / Frequency	50-60 Hz
Isolamento elettrico Electrical isolation	Classe I Class I
Grado di protezione elettrica Electrical class protection	IP31

### Struttura / Construction

Scocca Casing	ABS
Filtro EPA E11 / EPA E11 Filter	Di serie / Standard
Dimensioni (LxPxH) Dimensions (WxDxH)	298x170x565 mm
Peso / Weight	7,2 Kg

### Funzionamento / Operation

Attivazione / Activation	Automatico (Sensori a infrarossi) Automatic infrared detector
Velocità dell'aria / Air speed	410 Km/h (in uscita / output)
Volume d'aria / Air flow	187 m <sup>3</sup> /h
Rumorosità (da 1 M) Noise level (@ 1 M)	75 dB
Velocità asciugatura / Drying time	12 - 15 sec.

### Accreditamento / Accrediations

Marchi di qualità / Quality marks	CE, RoHS
-----------------------------------	----------

### Codici prodotto / Product code

**Versione "PRO" motore brushless / "PRO" version brushless motor**

Bianco / White	<b>704260</b>
Grigio metallizzato / Satin-grey	<b>704262</b>

### Accessori & ricambi / Accessories & spare parts

Filtro EPA E11 / EPA E11 filter	<b>704936</b>
---------------------------------	---------------







## X-DRY COMPACT



Molto più compatto rispetto ai modelli dell'omonima serie, X-Dry Compact è concepito per offrire un'asciugatura efficace ed ultraveloce in soli 12-15 secondi. Il dryer incorpora un motore a spazzole da 1.100 W ed un corpo riscaldante regolabile manualmente da 350 W. La presenza di una lampada UV antibatterica, posta in prossimità della vaschetta di scarico dell'acqua, assicura migliori standard igienici.

X-Dry Compact is a smart dryer designed for medium-high traffic areas. Extremely compact in size but ergonomic in design, it offers outstanding performance with a drying time of only 12-15 seconds. To conserve energy and optimize hygiene, it also incorporates an intelligent switchable heating element for hot/cold airflow as well as a UV lamp that sanitizes the drain tank.

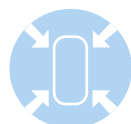

**DESIGN ULTRA-COMPATTO** - Le dimensioni estremamente ridotte conferiscono al dryer una maggiore flessibilità d'installazione, anche in ambienti poco spaziosi o gravati da vincoli architettonici.

**ULTRA-COMPACT DESIGN** - Thanks to its compact size, X-Dry Compact can be easily fitted in any washroom. It's a great choice for small toilets having very tight spaces or where multiple units are required.



**REGOLAZIONE ARIA CALDA/FREDDA** - La temperatura dell'aria è regolabile manualmente con pulsante ON/OFF, per ottimizzare i consumi durante la stagione estiva e migliorare il comfort d'asciugatura nel periodo invernale.

**ADJUSTABLE HEAT CONTROL** - To offer higher efficiency and greater comfort in use, the heater can be activated or deactivated according to preferences. The ON/OFF button is located at the bottom of the unit.



**STERILIZZAZIONE UV** - Grazie alla presenza di una lampada UV, installata in prossimità del serbatoio di scarico, X-Dry Compact sfrutta l'irradiazione a raggi ultravioletti per prevenire l'insorgenza di cariche batteriche.

**UV STERILIZATION** - The dryer is equipped with a special ultraviolet lamp for improved bacterial control. The device is placed close to the drain tank, allowing to collect purified water.



**SERBATOIO DI SCARICO** - Il dryer incorpora una vaschetta di recupero con funzione "troppo pieno" che cattura l'acqua d'asciugatura. Il serbatoio è estraibile, facile da svuotare e pulire, per prevenire la formazione di muffe e cattivi odori.

**DRAIN TANK** - The unit incorporates a built-in drain tank with overflow pump that catches water droplets coming off users' hands. Being removable, the tank can be easily empty and clean to both avoid overflows and bad smells.



**DOBPIO FILTRO EPA (DI SERIE)** - X-Dry Compact include di serie un doppio filtro EPA E11, che purifica l'aria in fase d'aspirazione eliminando fino al 97,66% delle microparticelle presenti prima del processo d'asciugatura.

**DOUBLE EPA FILTER (AS STANDARD)** - X-Dry Compact comes as standard with two EPA E11 filter, which purify the air by trapping up to 97,66% of dust micro-particles, pollen and bacteria suspended in the incoming air flow.

Caratteristiche elettriche / Electrical specifications	
Numero motori / Number of motors	1
Tipo motore / Motor type	Motore AC con spazzole Ac brush motor
Potenza totale / Total power	1.450 W
Potenza motore / Motor power	1.100 W
Potenza resistenza Heating element power	350 W
Voltaggio / Voltage	220-240 V
Frequenza / Frequency	50-60 Hz
Isolamento elettrico Electrical isolation	Classe II Class II
Grado di protezione elettrica Electrical class protection	IP31
Struttura / Construction	
Scocca / Casing	ABS / ABS
Filtro EPA E11 / EPA E11 Filter	Di serie / Standard
Dimensioni (LxPxH) Dimensions (WxDxH)	296x177x566mm
Peso / Weight	6,5 kg
Funzionamento / Operation	
Attivazione / Activation	Automatico (sensori a infrarossi) Automatic infrared detector
Velocità dell'aria / Air speed	410 Km/h (in uscita / output)
Volume d'aria / Air flow	187 m <sup>3</sup> /h
Rumorosità (da 1 M) Noise level (@ 1 M)	75 dB
Velocità asciugatura / Drying time	12-15 sec.
Accreditamento / Accreditations	
Marchi di qualità / Quality marks	CE, RoHS
Codici prodotto / Product code	
Bianco / White	<a href="#">704255</a>
Grigio metallizzato / Satin-grey	<a href="#">704257</a>
Nero / Black	<a href="#">704259</a>
Accessori & ricambi / Accessories & spare parts	
Filtro EPA E11 / EPA E11 filter	<a href="#">704936</a>



## BAYAMO



Bayamo offre tutte le prestazioni e l'efficienza di un jet dryer con il medesimo comfort d'asciugatura di un tradizionale prodotto ad aria calda. Un puro concentrato di tecnologia e funzionalità, senza sacrificare la sicurezza. L'unità incorpora un sensore in grado di rilevare la temperatura ambiente e regolare automaticamente il calore della resistenza, così da evitare inutili sprechi di energia.

Blowing water from hands in less than 10 seconds, Bayamo is one of the most efficient and powerful 'hands-in' dryers on market. Super-reliable and perfect to handle heavy crowds in high traffic washrooms, this device combines top-notch technology with cutting-edge functionality. It incorporates an air sensor which detects ambient temperature, then automatically adjusting the heater.



**IGIENE GARANTITA** - La scocca in ABS è realizzata con uno speciale additivo antibatterico e anti-UV. Nel dryer sono presenti due dispositivi LED a raggi UV che sterilizzano il flusso d'aria nel punto d'aspirazione ed in quello d'uscita.

**ENHANCED HYGIENE** - The shell incorporates anti-microbial and anti-UV technology, inhibiting the growth of bacteria. It is also equipped with two UV LED devices which sanitize the air stream both in the air intake and output area.



**PANNELLO DI REGOLAZIONE INTEGRATO** - Specifici selettori consentono di accendere o spegnere il dryer (ON/OFF); attivare o disattivare la resistenza; regolare la potenza del motore scegliendo tra due velocità dell'aria (HIGH/LOW).

**INTEGRATED ADJUSTMENT PANEL** - In-built switchers allows to choose the operation mode. You can activate/deactivate the unit (ON/OFF); switch the heating element ON/OFF for instant hot air flow; adjust airflow speed (HIGH/LOW).



**MONITORAGGIO CICLO D'ASCIUGATURA** - Un display LED posto sulla sommità dell'apparecchio consente di controllare il tempo d'asciugatura. Due spie luminose identificano lo stato d'accensione e l'eventuale entrata in protezione del dryer.

**DRYING CYCLE QUICK CHECK** - A LED screen is placed on top of the dryer, allowing the user to quickly check the drying cycle status, while two LED indicators show when the unit is working and when an error occurs.



**SERBATOIO DI SCARICO** - Bayamo incorpora una vaschetta di recupero con funzione "troppo pieno" che cattura l'acqua d'asciugatura. Il serbatoio è estraibile, facile da svuotare e pulire, per prevenire la formazione di muffe e cattivi odori.

**DRAIN TANK** - Bayamo incorporates a built-in drain tank with overflow pump that catches water droplets coming off users' hands. Being removable, the tank can be easily empty and clean to both avoid overflows and bad smells.



**FILTRI ARIA / EPA** - Il dryer è fornito di serie con un pre-filtro d'aspirazione lavabile in acqua. In opzione, è possibile avere un filtro EPA E11, che garantisce una maggior purificazione dell'aria contro polvere, pollini e batteri.

**AIR/EPA FILTERS** - The dryer comes as standard with a washable air pre-filter. It can also incorporate a replacable EPA filter, which traps up to 97,66% of dust micro-particles suspended in the incoming air stream.

### Caratteristiche elettriche / Electrical specifications

Numero motori / Number of motors	1
Tipo motore / Motor type	Motore AC con spazzole Ac brush motor
Potenza totale / Total power	1.900 W
Potenza motore / Motor power	900 W
Potenza resistenza Heating element power	1.000 W (ON-OFF)
Voltaggio / Voltage	220-240 V
Frequenza / Frequency	50-60 Hz
Isolamento elettrico Electrical isolation	Classe II Class II
Grado di protezione elettrica Electrical class protection	IP44

### Struttura / Construction

Scocca Casing	ABS antibatterico e anti-UV Antibacterial and anti-UV ABS
Filtro aria / Air filter	Di serie / Standard
Filtro EPA E11 / EPA E11 Filter	In opzione / As option
Dimensioni (LxPxH) Dimensions (WxDxH)	300x220x700 mm
Peso / Weight	9,5 Kg

### Funzionamento / Operation

Attivazione / Activation	Automatico (sensori a infrarossi) Automatic infrared detector
Velocità dell'aria Air speed	95 m/s (in uscita / output)
Volume d'aria / Air flow	190 m <sup>3</sup> /h
Rumorosità (da 1 M) Noise level (@ 1 M)	72 dB
Velocità asciugatura / Drying time	10 - 12 sec.

### Accreditamento / Accrediations

Marchi di qualità / Quality marks	CE, RoHS
-----------------------------------	----------

### Codici prodotto / Product code

Bianco / White	<b>160010</b>
Grigio metallizzato / Satin-grey	<b>160012</b>

### Accessori & ricambi / Accessories & spare parts

Filtro EPA E11 / EPA E11 filter	<b>160015</b>
Box per filtro EPA / Box for EPA filter	<b>160990</b>



## MOCKA



Mocka catturerà la vostra attenzione per il suo design stravagante. Questo smart dryer, ideato per contesti a medio-alto traffico d'utenza, offre prestazioni d'asciugatura eccellenti, tipiche di un jet dryer, allo stesso livello di comfort di un tradizionale prodotto ad aria calda. Inoltre, la presenza di un termostato garantisce massima sicurezza, prevenendo surriscaldamenti, sovraccarichi e cortocircuiti.

Suitable for medium traffic toilets, Mocka has a sophisticated and unconventional design since it incorporates a contoured water collection tray which catches droplets. Mocka performs as a jet dryer while offering the highest level of comfort as traditional devices do. It's also safety, as it includes a protection against overheating, overload and short-circuit.



**PROTEZIONE ANTIBATTERICA** - La scocca è realizzata con uno speciale additivo che rende l'ABS antibatterico. L'attivazione tramite sensore a fotocellula previene il contatto con l'unità, rendendo l'asciugatura mani più igienica.

**ANTIBACTERIAL PROTECTION** - The shell incorporates a special antimicrobial additive to inhibit bacteria growth. The touch-free automatic activation promotes hand hygiene, without the risk of cross-contamination by touching buttons.



**REGOLAZIONE ARIA CALDA/FREDDA** - A seconda delle preferenze dell'utente, è possibile inserire o disattivare la resistenza elettrica. Il selettore di temperatura (ON/OFF) è posto nell'incavo del vano d'asciugatura.

**ADJUSTABLE HEAT CONTROL** - Depending on the user's preferences or season, the heating element can be switched on or off by pushing the dedicated controller placed on top of the drying zone area.

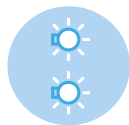

**SPIE DI CONTROLLO** - Il pannello frontale ospita due indicatori a LED, uno verde ed uno blu, che identificano lo stato di funzionamento dell'apparecchio e l'eventuale entrata in protezione della macchina.

**LED INDICATORS** - The front panel includes two LED indicators, emitting green and blue light, that shows when the unit is turned on and when an error occurs.



**SERBATOIO DI SCARICO** - L'acqua d'asciugatura viene canalizzata in una vaschetta di recupero alla base del dryer. Il serbatoio è removibile per facilitarne lo svuotamento e la pulizia, così da prevenire la formazione di muffe e cattivi odori.

**DRAIN TANK** - Water is collected in a reservoir with level window. Being removable, the tank can be easily empty and clean, to avoid overflows and to prevent mold or bad smells from spreading.



**FILTRO ANTIPOLVERE (DI SERIE)** - Il dryer è fornito di serie con un filtro antipolvere, lavabile in acqua, che garantisce una maggiore purificazione dell'aria contro polvere, pollini e batteri.

**AIR FILTER (STANDARD)** - The unit comes as standard with a washable air filter, ensuring protection against dust microparticles as well as other pollutants suspended in the incoming air stream.

Caratteristiche elettriche / Electrical specifications	
Numero motori / Number of motors	1
Tipo motore / Motor type	Motore AC con spazzole Ac brush motor
Potenza totale / Total power	1.350 W
Potenza motore / Motor power	550 W
Potenza resistenza Heating element power	800 W (ON-OFF)
Voltaggio / Voltage	220-240 V
Frequenza / Frequency	50-60 Hz
Isolamento elettrico Electrical isolation	Classe II Class II
Grado di protezione elettrica Electrical class protection	IP44
Struttura / Construction	
Scocca / Casing	ABS antibatterico e anti-UV Antibacterial and anti-UV ABS
Filtro aria / Air filter	Di serie / Standard
Dimensioni (LxPxH) Dimensions (WxDxH)	250x165x470 mm
Peso / Weight	4,7 kg
Funzionamento / Operation	
Attivazione / Activation	Automatico (sensori a infrarossi) Automatic infrared detector
Velocità dell'aria / Air speed	360 Km/h (in uscita / output)
Volume d'aria / Air flow	195 m <sup>3</sup> /h - 60 l/s
Rumorosità (da 1 M) Noise level (@ 1 M)	72 dB
Velocità asciugatura / Drying time	12-15 sec.
Accreditamento / Accreditations	
Marchi di qualità / Quality marks	CE, RoHS
Codici prodotto / Product code	
Bianco / White	<b>160100</b>
Grigio metallizzato / Satin-grey	<b>160102</b>
Accessori & ricambi / Accessories & spare parts	
Filtro aria / Air filter	<b>160985</b>



## DRY MAX UV



Dry Max UV è uno smart dryer per location a medio-alta traffico d'utenza. La possibilità di regolare la temperatura dell'aria consente un notevole risparmio energetico. Massimi standard d'igiene garantiti dalla presenza di una lampada UV antibatterica nel condotto d'areazione ed un filtro EPA E11 per purificare l'aria dalle microparticelle.

Dry Max UV is a smart dryer for medium-high traffic locations. The possibility to set the air temperature allows considerable energy savings. Maximum hygiene standards are guaranteed by the presence of an antibacterial UV lamp and a EPA filter that purifies the incoming air flow.



**ATTIVAZIONE AUTOMATICA** - Il ciclo d'asciugatura è ottimizzato da un sistema automatico con sensore a fotocellula. L'attivazione no-touch previene il contatto dell'utente con il dryer, garantendo massimi standard igienici.

**TOUCHLESS TECHNOLOGY** - The unit automatically turns on when hands pass under the infrared sensors installed in the drying area. The touch-free activation promotes hand hygiene, without the risk of cross-contamination.



**REGOLAZIONE ARIA CALDA/FREDDA** - La temperatura del flusso è regolabile tramite un pulsante ON/OFF, per ottimizzare i consumi durante la stagione estiva e migliorare il comfort d'asciugatura durante il periodo invernale.

**ADJUSTABLE HEAT CONTROL** - To offer higher efficiency and greater comfort in use, the heater can be activated or deactivated according to preferences. The ON/OFF button is located at the bottom of the unit.



**STERILIZZAZIONE UV** - Il prodotto ospita al proprio interno una lampada UV funzionale alla disinfezione del condotto di ventilazione, quindi dell'aria impiegata per l'asciugatura delle mani.

**UV STERILIZATION** - The unit is equipped with a special ultraviolet lamp for improved bacterial control. The device is placed inside the dryer to purify the air stream.



**VARIATORE DI REGOLAZIONE** - Il dryer è dotato di un variatore per la regolazione della velocità del motore. Questo componente influisce sul numero dei giri del motore, quindi sulla rumorosità dell'apparecchio.

**ADJUSTMENT VARIATOR** - The dryer is equipped with a variator to adjust motor speed. This component impacts on the engine RPM and therefore on the noise level of the unit.



**FILTRO EPA (INCLUSO)** - L'apparecchio è equipaggiato con filtro EPA E11 che garantisce protezione contro il 97,66% delle particelle e dei batteri presenti nell'aria utilizzata durante l'asciugatura.

**EPA FILTER (INCLUDED)** - The unit incorporates a replaceable EPA filter, which purifies the air by trapping up to 97,66% of dust microparticles and bacteria in the incoming air flow.

### Caratteristiche elettriche / Electrical specifications

Numero motori / Number of motors	1
Tipo motore / Motor type	Motore AC con spazzole Ac brush motor
Potenza totale / Total power	450 - 1000 W
Potenza motore / Motor power	225 - 500 W
Potenza resistenza Heating element power	225 - 500 W (ON-OFF)
Voltaggio / Voltage	220-240 V
Frequenza / Frequency	50-60 Hz
Isolamento elettrico Electrical isolation	Classe II Class II
Grado di protezione elettrica Electrical class protection	IP34

### Struttura / Construction

Scocca Casing	ABS - Nylon
Filtro EPA E11 / EPA E11 Filter	Incluso / Standard
Dimensioni (LxPxH) Dimensions (WxDxH)	180x97x280 mm
Peso / Weight	1,86 Kg

### Funzionamento / Operation

Attivazione / Activation	Automatico (sensori a infrarossi) Automatic infrared detector
Velocità dell'aria Air speed	191 - 260 Km/h (in uscita / output)
Volume d'aria / Air flow	120 m <sup>3</sup> /h
Rumorosità (da 2 M) Noise level (@ 2 M)	68-75 dB
Velocità asciugatura / Drying time	15 sec.

### Accreditamento / Accreditations

Marchi di qualità / Quality marks	CE, RoHS
-----------------------------------	----------

### Codici prodotto / Product code

Bianco / White	<a href="#">704520</a>
Cromato / Chromed	<a href="#">704521</a>
Satinato / Brushed	<a href="#">704522</a>
Nero / Black	<a href="#">704529</a>

### Accessori & ricambi / Accessories & spare parts

Filtro EPA E11 / EPA E11 filter	<a href="#">704995</a>
---------------------------------	------------------------



DISPONIBILE IN AR SU MEDIAL APP  
AVAILABLE IN AR ON MEDIAL APP





## ZEFIRO PRO UV



Zefiro Pro UV incorpora funzionalità più evolute rispetto ai modelli tradizionali dell'omonima gamma. Concepito per aree medio-alta frequentazione, include una lampada UV antibatterica. Grazie a quest'ultimo componente, l'installazione dell'unità è particolarmente indicata anche in contesti sensibili, come quello ospedaliero e alimentare.

By incorporating additional and more advanced features, Zefiro Pro UV expands our offer even further. Designed for medium-high-traffic areas, this smart dryer includes an antibacterial UV lamp. Thanks to this last feature, Zefiro Pro UV is suitable for installation in sensitive locations, such as hospitals and food areas.



**COMFORT AL TOP** - La zona d'asciugatura a cono d'aria è facilmente accessibile, permettendo a qualsiasi utente di mantenere una postura naturale e confortevole durante l'attesa.

**ENHANCED COMFORT** - The drying zone with air-cone outlet shape is wide and easily accessible, making hand insertion more comfortable for the majority of people while waiting.



**REGOLAZIONE ARIA CALDA/FREDDA** - Il dryer è dotato di una resistenza elettrica interna. La regolazione del flusso d'aria (calda o fredda) è personalizzabile in base alle esigenze stagionali o alla preferenza del cliente.

**INSTANT HOT AIR** - The unit is equipped with heater, which allows you to regulate the air flow (hot or cold) according to seasonal needs or customer's preferences.



**STERILIZZAZIONE UV** - Zefiro Pro UV ospita al proprio interno una lampada UV funzionale alla disinfezione del condotto di ventilazione, quindi dell'aria impiegata per l'asciugatura delle mani.

**UV STERILIZATION** - Zefiro Pro UV is equipped with a special ultraviolet lamp for improved bacterial control. The device is placed inside the dryer to purify the air stream.



**ANTIVANDALISMO** - Le cover in acciaio inox sono ideali in ambienti a rischio vandalismo poiché progettate per resistere ai tentativi di furto e alle manomissioni operate da eventuali malintenzionati.

**VANDAL PROOF** - The stainless steel covers are designed to withstand tampering or impacts of blunt objects thrown vigorously by vandals. These kind of covers are ideal to avoid vandal-attacks as well as in high traffic areas.



**FILTRO EPA (DI SERIE)** - L'apparecchio è equipaggiato di serie con filtro EPA E11 che garantisce protezione contro il 97,66% dei batteri presenti nell'aria utilizzata durante l'asciugatura.

**EPA FILTER (STANDARD)** - Zefiro Pro UV may incorporate a replaceable EPA E11 filter which purifies the air by trapping up to 97,66% of dust micro-particles, pollen and bacteria suspended in the incoming air flow.



Caratteristiche elettriche / Electrical specifications	
Numero motori / Number of motors	1
Tipo motore / Motor type	Motore AC con spazzole Ac brush motor
Potenza totale / Total power	1.100 W
Potenza motore / Motor power	550 W
Potenza resistenza Heating element power	550 W (ON-OFF)
Voltaggio / Voltage	220-240 V
Frequenza / Frequency	50-60 Hz
Isolamento elettrico Electrical isolation	Classe II Class II
Grado di protezione elettrica Electrical class protection	IP23
Struttura / Construction	
Scocca Casing	Polipropilene, metallo, inox AISI 304 Polypropylene, steel, AISI 304 s.steel
Filtro EPA E11 / EPA E11 Filter	Di serie / Standard
Dimensioni (LxPxH) Dimensions (WxDxH)	221x157x285 mm
Peso / Weight	2,55 Kg (polipropilene / polypropylene) 3,05 Kg (inox / s.steel)
Funzionamento / Operation	
Attivazione / Activation	Automatico (sensori a infrarossi) Automatic infrared detector
Velocità dell'aria Air speed	300 Km/h (in uscita / output)
Volume d'aria / Air flow	187 m <sup>3</sup> /h
Rumorosità (da 1 M) Noise level (@ 1 M)	75 dB
Velocità asciugatura / Drying time	12 - 15 sec.
Accreditamento / Accreditations	
Marchi di qualità / Quality marks	CE, RoHS
Codici prodotto / Product code	
Poliprop. bianco / White polyprop.	<b>704500</b>
Metallo bianco / White steel	<b>704510</b>
Inox 304 lucido / Polished s. steel 304	<b>704511</b>
Inox 304 satin. / Brushed s. steel 304	<b>704512</b>
Metallo nero / Black steel	<b>704519</b>
Accessori & ricambi / Accessories & spare parts	
Filtro EPA E11 / EPA E11 filter	<b>704995</b>





## ZEFIRO



Zefiro è la linea d'asciugamani più completa all'interno del segmento dei jet dryer. Ideale in toilettes a medio-alta affluenza, incorpora un motore a spazzola da 1.100 W a risparmio energetico, assicurando un'asciugatura ottimale in pochi secondi. Ampio è l'assortimento dei modelli disponibili, che differiscono per materiali e finiture delle cover, ma soprattutto per le due modalità di fuoriuscita dell'aria.

Zefiro is the broadest and most complete range of hand dryers in the "jet" category. Great for medium-high traffic toilets, it incorporates a 1.100 W cost-saving brush motor, offering an ultra-fast drying time in just 15 seconds. This range is available in a wide variety of materials, finishes and air outlet shapes.

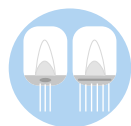

**EROGAZIONE A CONO O LAMA D'ARIA** - La versione a cono d'aria convoglia il flusso in modo uniforme. La versione a lama rende più ampia la zona d'asciugatura.

**CONE OR BLADE AIR OUTLET** - The dryer is available in two different outlet shape versions. The cone outlet shape conveys the air flow evenly, while the blade outlet shape makes the drying area wider.



**MASSIMO RISPARMIO ENERGETICO** - Essendo privo di resistenza elettrica, Zefiro sfrutta la velocità dell'aria per garantire una perfetta e rapida asciugatura delle mani in soli 15 secondi.

**TOP EFFICIENCY AND ENERGY SAVING** - For even greater efficiencies, Zefiro has no heating element. It uses jet streams of air to dry hands in 15 seconds. Auto turn-on thanks to infra-red sensors.



**DESIGN SOFISTICATO** - Grazie al suo design moderno ed elegante, Zefiro si adatta perfettamente a tutti gli stili architettonici. Le superfici arrotondate rendono il prodotto ancor più igienico e facile da pulire.

**SOPHISTICATED DESIGN** - Thanks to its modern and sleek shape, Zefiro perfectly fits into all architectural styles. The covers rounded lines makes Zefiro easier to clean.



**ANTIVANDALISMO** - Le cover in alluminio sono ideali in ambienti a rischio vandalismo poiché progettate per resistere ai tentativi di furto e alle manomissioni operate da eventuali malintenzionati.

**VANDAL PROOF** - The protective aluminium outer shells are designed to withstand tampering or impacts of blunt objects thrown vigorously by vandals.



**FILTRO EPA (IN OPZIONE)** - Zefiro può essere integrato con filtro EPA E11 che purifica l'aria in fase d'aspirazione eliminando fino al 97,66% delle microparticelle e dei batteri presenti prima del processo d'asciugatura.

**EPA FILTER (AS OPTION)** - Zefiro may incorporate a replaceable EPA E11 filter which purifies the air by trapping up to 97,66% of dust microparticles suspended in the incoming air flow.

Caratteristiche elettriche / Electrical specifications		
Numero motori / Number of motors	1	
Tipo motore / Motor type	Motore AC con spazzole Ac brush motor	
Potenza totale / Total power	1.100 W	
Potenza motore / Motor power	1.100 W	
Potenza resistenza Heating element power	Nessuna / No heater	
Voltaggio / Voltage	220-240 V	
Frequenza / Frequency	50-60 Hz	
Isolamento elettrico Electrical isolation	Classe II Class II	
Grado di protezione elettrica Electrical class protection	IP23	
Struttura / Construction		
Scocca / Casing	ABS o alluminio pressofuso ABS or die cast aluminium	
Filtro EPA E11 / EPA E11 Filter	In opzione / As option	
Dimensioni (LxPxH) Dimensions (WxDxH)	221x157x285 mm	
Peso / Weight	3 Kg (ABS) 5 Kg (alluminio / aluminium)	
Funzionamento / Operation		
Attivazione / Activation	Automatico (sensori a infrarossi) Automatic infrared detector	
Velocità dell'aria / Air speed	325 Km/h (in uscita / output)	
Volume d'aria / Air flow	187 m <sup>3</sup> /h	
Rumorosità (da 1 M) Noise level (@ 1 M)	80 dB	
Velocità asciugatura / Drying time	15 sec.	
Accreditamento / Accreditations		
Marchi di qualità / Quality marks	CE, RoHS	
Codici prodotto / Product code		
Zefiro	Cono d'aria Cone outlet shape	Lama d'aria Blade outlet shape
ABS bianco / White ABS	<a href="#">704350</a>	<a href="#">704300</a>
Alluminio bianco / White aluminium	<a href="#">704360</a>	<a href="#">704310</a>
Allum. cromato / Chromed aluminium	<a href="#">704361</a>	<a href="#">704311</a>
Allum. satinato / Brushed aluminium	<a href="#">704362</a>	<a href="#">704312</a>
ABS blu / Blue ABS		<a href="#">704300STBL</a>
ABS Nero / Black ABS		<a href="#">704309</a>
Accessori & ricambi / Accessories & spare parts		
Filtro EPA E11 / EPA E11 filter	<a href="#">704995</a>	



## ZEFIRO HOT



A differenza dei modelli Zefiro, questa serie include una resistenza elettrica da 550 W che consente di intiepidire il flusso d'asciugatura sin dai primi istanti d'utilizzo. Questo dryer è dotato di un motore a spazzole da 550 W. Erogando un potente flusso d'aria ad una velocità d'uscita di 250 km/h, Zefiro Hot offre un'asciugatura perfetta in soli 15 secondi, pur ottimizzando i consumi energetici.

Unlike the other dryers from the same range, Zefiro Hot includes a 550 W heater which allows to warm the drying flow from the first instants of use. Entirely designed and manufactured in Italy, this dryer is operated by a reliable 550 W brush motor. Delivering a powerful airflow at an output speed of 250 km/h, Zefiro Hot offers perfect drying in just 15 seconds, while optimizing energy consumption.

Caratteristiche elettriche / Electrical specifications	
Numero motori / Number of motors	1
Tipo motore / Motor type	Motore AC con spazzole Ac brush motor
Potenza totale / Total power	1.100 W
Potenza motore / Motor power	550 W
Potenza resistenza Heating element power	550 W
Voltaggio / Voltage	220-240 V
Frequenza / Frequency	50-60 Hz
Isolamento elettrico Electrical isolation	Classe II Class II
Grado di protezione elettrica Electrical class protection	IP23
Struttura / Construction	
Scocca Casing	ABS o alluminio pressofuso ABS or die cast aluminum
Filtro EPA E11 / EPA E11 Filter	In opzione / As option
Dimensioni (LxPxH) Dimensions (WxDxH)	221x157x285 mm
Peso / Weight	3 Kg (ABS) 5 Kg (alluminio / aluminium)
Funzionamento / Operation	
Attivazione / Activation	Automatico (sensori a infrarossi) Automatic infrared detector
Velocità dell'aria Air speed	250 Km/h (in uscita / output)
Volume d'aria / Air flow	126 m <sup>3</sup> /h
Rumorosità (da 1 M) Noise level (@ 1 M)	75 dB
Velocità asciugatura / Drying time	15 sec.
Accreditamento / Accreditations	
Marchi di qualità / Quality marks	CE, RoHS
Codici prodotto / Product code	
ABS bianco / White ABS	<b>704325</b>
Alluminio bianco / White aluminium	<b>704335</b>
Allum. cromato / Chromed aluminium	<b>704336</b>
Allum. satinato / Brushed aluminium	<b>704337</b>
Accessori & ricambi / Accessories & spare parts	
Filtro EPA E11 / EPA E11 filter	<b>704995</b>



**COMFORT AL TOP** - La zona d'asciugatura a lama d'aria è facilmente accessibile, permettendo a qualsiasi utente di mantenere una postura naturale e confortevole durante l'attesa.

**ENHANCED COMFORT** - The drying zone with air-blade outlet shape is wide and easily accessible, making hand insertion more comfortable for the majority of people while waiting.



**ARIA CALDA ISTANTANEA** - Zefiro Hot è dotato di resistenza elettrica, che consente di erogare istantaneamente un piacevole flusso d'aria calda e migliorare il comfort d'utilizzo durante la stagione invernale.

**INSTANT HOT AIR** - Zefiro Hot is equipped with heater, an element that allows for the instantaneous preparation of hot air contributing to increased comfort during the winter.



**ANTIVANDALISMO** - Le cover in alluminio sono ideali in ambienti a rischio vandalismo poiché progettate per resistere ai tentativi di furto e alle manomissioni operate da eventuali malintenzionati.

**VANDAL PROOF** - The aluminum covers are designed to withstand tampering or impacts of blunt objects thrown vigorously by vandals. These kind of covers are ideal in high traffic areas.



**DESIGN SOFISTICATO** - Grazie al suo design moderno ed elegante, Zefiro Hot si adatta perfettamente a tutti gli stili architettonici. Le superfici smussate rendono il prodotto ancor più igienico e facile da pulire.

**SOPHISTICATED DESIGN** - Thanks to its modern and elegant shape, Zefiro Hot perfectly fits into all washrooms. The covers rounded lines makes Zefiro Hot easier to clean.



**FILTRO EPA (IN OPZIONE)** - L'apparecchio può essere dotato di filtro EPA E11 che garantisce protezione contro il 97,66% dei batteri presenti nell'aria utilizzata durante l'asciugatura.

**EPA FILTER (AS OPTION)** - Zefiro Hot may incorporate a replaceable EPA E11 filter which purifies the air by trapping up to 97,66% of dust microparticles suspended in the incoming air flow.



## MINI ZEFIRO



Mini Zefiro rappresenta il sistema d'asciugatura ideale per i bagni di piccole dimensioni. Alimentato da un potente motore con resistenza, questo smart dryer risulta ancor più performante ed economico rispetto ai modelli più grandi della stessa categoria. Pur essendo concepito per bagni a medio-bassa affluenza, Mini Zefiro garantisce tempi d'asciugatura estremamente ridotti, in soli 20 secondi.

Mini Zefiro is the ideal solution for any small restroom requiring an efficient drying system. Operated by a heater-free 900 W motor, this dryer is even more powerful and cost-effective when compared to larger models in the same segment. A great choice for medium-low washroom environments, Mini Zefiro perfectly dries the hands in just 20 seconds.



**CONSUMI CONTENUTI** - Con un motore a corrente alternata da soli 400 W ed integrato da una resistenza elettrica da 500 W, Mini Zefiro garantisce prestazioni d'asciugatura eccellenti con un consumo energetico ridottissimo.

**ENERGY-SAVING** - Designed with super speedy technology in mind, Mini Zefiro is operated by a powerful 400 AC motor, incorporating a 500 W heating element. This massively lowers the energy consumption.



**ARIA CALDA ISTANTANEA** - L'asciugatura è resa più efficace e confortevole dalla presenza di una resistenza elettrica che riscalda il flusso d'aria sin dai primi istanti d'attivazione.

**INSTANT WARM AIR** - To offer a greater comfort in use, the dryer incorporates a heater that instantly warms the air during hand drying operations.

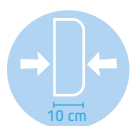

**DESIGN ULTRA-COMPATTO** - Con una profondità di soli 10 cm, Mini Zefiro è piccolo e compatto. Ciò nonostante, il foro d'erogazione a cono è ampio, consentendo una perfetta asciugatura delle mani.

**ULTRA-COMPACT DESIGN** - It comes with an ultra-compact shape, only 10 cm depth. Nevertheless, the wide cone nozzle design spreads airflow across a large area, ensuring both hands are dried at the same time.



**ATTIVAZIONE AUTOMATICA** - Il dryer è dotato di un sensore di rilevamento ad infrarossi che percepisce la presenza delle mani al di sotto del vano d'asciugatura, azionando un flusso d'aria conico che viaggia a ben 200 km/h.

**AUTOMATIC ACTIVATION** - The dryer is equipped with an effective infrared sensor which detects the hands placed below the dryer, thereby activating a 200 km/h air stream.



**FILTRO EPA (IN OPZIONE)** - Può essere integrato con filtro EPA E11 che purifica l'aria in fase d'aspirazione eliminando fino al 97,66% delle microparticelle presenti prima del processo d'asciugatura.

**EPA FILTER (AS OPTION)** - Mini Zefiro may incorporate a replaceable EPA E11 filter which purifies the air by trapping up to 97,66% of dust microparticles suspended in the incoming air flow.

### Caratteristiche elettriche / Electrical specifications

Numero motori / Number of motors	1
Tipo motore / Motor type	Motore AC con spazzole Ac brush motor
Potenza totale / Total power	900 W
Potenza motore / Motor power	400 W
Potenza resistenza Heating element power	500 W
Voltaggio / Voltage	220-240 V
Frequenza / Frequency	50-60 Hz
Isolamento elettrico Electrical isolation	Classe II Class II
Grado di protezione elettrica Electrical class protection	IP23

### Struttura / Construction

Scocca / Casing	ABS
Filtro EPA E11 / EPA E11 Filter	In opzione / As option
Dimensioni (LxPxH) Dimensions (WxDxH)	156x99,5x238 mm
Peso / Weight	1,2 Kg

### Funzionamento / Operation

Attivazione / Activation	Automatico (sensori a infrarossi) Automatic infrared detector
Velocità dell'aria / Air speed	200 Km/h (in uscita / output)
Volume d'aria / Air flow	110 m <sup>3</sup> /h
Rumorosità (da 1 M) Noise level (@ 1 M)	70 dB
Velocità asciugatura / Drying time	20 sec.

### Accreditamento / Accreditations

Marchi di qualità / Quality marks	CE, RoHS
-----------------------------------	----------

### Codici prodotto / Product code

Bianco / White	<a href="#">704390</a>
Blu / Blue	<a href="#">704395</a>
Nero / Black	<a href="#">704399</a>
Cromato / Chromed	<a href="#">704391</a>
Satinato / Brushed	<a href="#">704392</a>

### Accessori & ricambi / Accessories & spare parts

Filtro EPA E11 / EPA E11 filter	<a href="#">704973</a>
---------------------------------	------------------------





## HAMET



Tra gli asciugamani tradizionali, Hamet è senza dubbio il modello più conosciuto e richiesto. Un vero e proprio punto di riferimento in termini di prestazioni, affidabilità e sicurezza. Dotato di un potente motore a spazzola con resistenza elettrica da 2.400 W, questo prodotto garantisce un'efficace e rapida asciugatura delle mani. Una soluzione ideale per centri commerciali, ricreativi ed aree di servizio.

Hamet is the most popular and requested conventional hand dryer, so much so that it represents a standard in terms of performance, reliability and security within the traditional dryer category. Operated by a powerful 2.400 W motor with a heating element, Hamet offers a quick and comfortable drying experience. A great choice in leisure facilities and gas stations.



**PRATICO E FUNZIONALE** - Propone uno stile d'asciugatura convenzionale, grazie all'ampio bocchettone girevole a 360° facilmente accessibile da qualunque utente, ivi inclusi anziani o persone con ridotte capacità motorie.

**EASY TO USE** - It offers a conventional "hands-under" drying style. The dryer comes with a 360° rotating nozzle, enabling users with varying levels of mobility to dry themselves comfortably and effectively.



**ARIA CALDA ISTANTANEA** - La resistenza elettrica incorporata nel dryer iniepidisce istantaneamente il flusso d'aria impiegato durante il ciclo d'asciugatura, rendendone più confortevole l'utilizzo.

**INSTANT HOT AIR** - The dryer incorporates a heater, an element that allows for the instantaneous preparation of hot air contributing to increased comfort during the winter.



**DUE TIPI DI ATTIVAZIONE** - È disponibile nella versione manuale, con accensione a pulsante, o nella versione a sensore infrarossi, che attiva il dryer automaticamente quando rileva la presenza delle mani sotto il vano d'asciugatura.

**TWO TYPES OF ACTIVATION** - The automatic version takes advantage of infrared sensors to detect the hands once placed under the blower. Hamet is also available with a traditional push button activation.



30" - 3'

**TIMER REGOLABILE** - Nella versione a pulsante, Hamet include anche un timer per regolare manualmente il tempo d'asciugatura con un intervallo che può estendersi da 30 secondi a 3 minuti.

**ADJUSTABLE TIMER** - The push-activation version also incorporates an adjustable timer which allows to set the drying time from 30 seconds to 3 minutes.



**ANTIVANDALISMO** - Le cover in acciaio sono ideali in ambienti a rischio vandalismo poiché progettate per resistere ai tentativi di furto e alle manomissioni operate da eventuali malintenzionati.

**VANDAL PROOF** - The protective steel outer shells are designed to withstand tampering or impacts of blunt objects thrown vigorously by vandals

### Caratteristiche elettriche / Electrical specifications

Numero motori / Number of motors	1
Tipo motore / Motor type	Motore AC con spazzole Ac brush motor
Potenza totale / Total power	2.400 W
Potenza motore / Motor power	200 W
Potenza resistenza Heating element power	2.200 W
Voltaggio / Voltage	220-240 V
Frequenza / Frequency	50-60 Hz
Isolamento elettrico Electrical isolation	Classe I Class I
Grado di protezione elettrica Electrical class protection	IPX1

### Struttura / Construction

Scocca Casing	Acciaio o inox AISI 304 antivandalo Vandal proof steel or s.steel AISI 304
Filtro aria / Air filter	Non disponibile / Not available
Dimensioni (LxPxH) Dimensions (WxDxH)	278x213x243 mm
Peso / Weight	7 Kg

### Funzionamento / Operation

Attivazione / Activation	Pulsante o automatico (sensore ad infrarossi) Push button or automatic (infra-red detector)
Velocità dell'aria (regolabile) Air speed (adjustable)	101 Km/h (in uscita / output)
Volume d'aria / Air flow	330 m <sup>3</sup> /h
Rumorosità (da 1 M) Noise level (@ 1 M)	70 dB
Velocità asciugatura / Drying time	35 sec.

### Accreditamento / Accreditations

Marchi di qualità / Quality marks	CE, RoHS
-----------------------------------	----------

### Codici prodotto / Product code

<b>Hamet (accensione a pulsante) / Hamet (push button activation)</b>	
Acciaio bianco / White steel	<a href="#">704175</a>
Inox 304 brillante / Polished 304 s.steel	<a href="#">704176</a>
Inox 304 satinato / Brushed 304 s.steel	<a href="#">704177</a>
<b>Hamet (accensione a sensore) / Hamet (sensor activation)</b>	
Acciaio bianco / White steel	<a href="#">704150</a>
Inox 304 brillante / Polished 304 s.steel	<a href="#">704151</a>
Inox 304 satinato / Brushed 304 s.steel	<a href="#">704152</a>



## ARIELIMP



Arielimp è un tradizionale asciugamano elettrico ad aria calda, dotato di una robusta scocca antivandalo in acciaio. Soluzione ottimale in contesti a medio traffico d'utenza ed ovunque sia richiesta resistenza agli atti vandalici, questo dryer si aziona a sensore, erogando un copioso getto d'aria calda che fluisce tramite un ampio bocchettone girevole a 360°.

Arielimp is a traditional hand dryer equipped with a sturdy vandal proof steel cover. Designed for medium-high traffic environments, this device is operated by a powerful brush motor which produces an abundant warm air flow passing through a wide nozzle. It comes with an infrared sensor for handsfree use and a built-in safety feature to automatically shut the dryer off after 180 seconds.



**COMFORT D'ASCIUGATURA** - Arielimp propone uno stile d'asciugatura convenzionale. Il bocchettone d'erogazione è ampio ed accessibile da qualunque utente, ivi inclusi anziani o persone con ridotte capacità motorie.

**COMFORT IN USE** - Arielimp offers a conventional "hands-under" drying style. The drying zone is wide and easily accessible by anyone, enabling users with varying levels of mobility to dry themselves effectively.



**ARIA CALDA Istantanea** - La resistenza elettrica incorporata nel dryer consente di intiepidire istantaneamente il flusso d'asciugatura, rendendone più confortevole l'utilizzo.

**INSTANT HOT AIR** - The dryer incorporates a heater, an element that allows for the instantaneous preparation of hot air contributing to increased comfort during the winter.



**ATTIVAZIONE AUTOMATICA** - Il funzionamento è ottimizzato da un sistema ad accensione/spengimento automatico, comandato da un sensore a fotocellula per assicurare elevati standard igienici.

**TOUCHLESS TECHNOLOGY** - Arielimp automatically turns on when hands are placed underneath the air outlet. The touch-free automatic activation promotes hand hygiene, without the risk of cross-contamination.



**ANTIVANDALISMO** - Le cover in inox sono opzioni ideali in tutti quei contesti a rischio vandalismo poiché sono progettate per resistere ai tentativi di furto e alle manomissioni operate da eventuali malintenzionati.

**VANDAL PROOF** - The stainless steel covers are designed to withstand tampering or impacts of blunt objects thrown vigorously by vandals. These kinds of covers are ideal in high traffic areas.



**BOCCHETTONE 360°** - Arielimp dispone di un bocchettone girevole a 360°, che consente di asciugare le mani, il viso ma anche i vestiti in modo pratico e sicuro. Una soluzione ideale in centri ricreativi e aree di servizio.

**360° ROTATING NOZZLE** - The dryer comes with a 360° rotating nozzle, enabling hands, faces, hair or clothes to be dried safely and easily. This feature makes Arielimp great for leisure facilities and gas stations.

### Caratteristiche elettriche / Electrical specifications

Numero motori / Number of motors	1
Tipo motore / Motor type	Motore AC con spazzole Ac brush motor
Potenza totale / Total power	2.500 W
Potenza motore / Motor power	250 W
Potenza resistenza Heating element power	2.250 W
Voltaggio / Voltage	220-240 V
Frequenza / Frequency	50-60 Hz
Isolamento elettrico Electrical isolation	Classe I Class I
Grado di protezione elettrica Electrical class protection	IPX1

### Struttura / Construction

Scocca / Casing	Inox AISI 304 / AISI 304 s.steel
Filtro aria / Air filter	Non disponibile / Not available
Dimensioni (LxPxH) Dimensions (WxDxH)	260x200x235 mm
Peso / Weight	4,6 Kg

### Funzionamento / Operation

Attivazione / Activation	Automatico (sensori a infrarossi) Automatic infrared detector
Velocità dell'aria / Air speed	101 Km/h (in uscita / output)
Volume d'aria / Air flow	270 m <sup>3</sup> /h
Rumorosità (da 1 M) Noise level (@ 1 M)	70 dB
Velocità asciugatura / Drying time	35 sec.

### Accreditamento / Accreditations

Marchi di qualità / Quality marks	CE, RoHS
-----------------------------------	----------

### Codici prodotto / Product code

Acciaio bianco / White steel	<b>ARIELIMPF</b>
Inox 304 brillante / Polished 304 s.steel	<b>ARIELIMPLF</b>
Inox 304 satinato / Brushed 304 s.steel	<b>ARIELIMPSE</b>







## QIBLI



Qibli è un tradizionale asciugamano ad aria calda, dall'estetica semplice ma raffinata. Particolarmente indicato in contesti a medio-bassa affluenza, questo dryer offre un'asciugatura efficace in circa 50 secondi. Disponibile in tre diverse finiture e due tipi d'attivazione, è il giusto compromesso per chi desidera installare un prodotto affidabile e silenzioso ad un ottimo rapporto qualità-prezzo.

Qibli is a traditional hand dryer with a sleek and contemporary design. Great in medium-low traffic toilets, it works diligently drying hands in about 50 seconds. Qibli is available in three different finishes, while there are two types of activation. This is the ideal solution for those who look for a reliable and quiet hand dryer, at a fair and value-for-money ratio.



**AFFIDABILE** - La tecnologia ad induzione, oltre ad estendere il periodo d'esercizio del dryer, consente di minimizzare gli interventi di manutenzione periodica, dato che il motore non dispone di elementi consumabili da sostituire nel tempo.

**RELIABLE** - Qibli is operated by a brushless motor. This technology not only extends the dryer life cycle, but it also helps minimize maintenance, as it does not incorporate consumable parts to replace over time.



**ARIA CALDA ISTANTANEA** - All'interno del dryer è installata una resistenza elettrica che riscalda istantaneamente il flusso d'asciugatura non appena la macchina viene messa in funzione.

**INSTANT HOT AIR** - The dryer incorporates a heating element that is designed to instantly warm the air stream coming from the blower as soon as the device is activated.



**DUE TIPI DI ATTIVAZIONE** - Qibli è proposto con attivazione automatica a sensore infrarossi o con attivazione manuale tramite pulsante. In quest'ultimo caso, il dryer include un timer che regola il tempo d'asciugatura tra 30 secondi e 3 minuti.

**TWO TYPES OF ACTIVATION** - The automatic version takes advantage of infrared sensors to detect the hands once placed under the blower fan. It is also available with push button activation and adjustable timer to set the drying time from 30 sec. to 3 min.



**MINIMO INGOMBRO** - Le dimensioni compatte ne rendono l'installazione particolarmente flessibile, soprattutto in bagni di piccole dimensioni. Grazie al suo design minimal, il dryer può essere anche posto sopra lavabo.

**COMPACT SIZE** - Thanks to its compact size, Qibli boasts many flexible installation options. It's great choice for small toilets having tight spaces or where multiple units are required.



**SILENZIOSO** - Con un volume d'aria di 45 l/s emesso ad una velocità massima di 80 km/h, questo dryer offre un'asciugatura efficace ma soprattutto silenziosa, dati i soli 60 dB emessi.

**QUIET** - By delivering an air volume of 45 l/s dispensed at a maximum speed of 80 km/h, this dryer ensures an effective but also silent drying, as it emits just 60 dB of noise whilst operating.

### Caratteristiche elettriche / Electrical specifications

Numero motori / Number of motors	1
Tipo motore / Motor type	Motore AC a induzione Ac brushless motor
Potenza totale / Total power	1.850 W
Potenza motore / Motor power	65 W
Potenza resistenza Heating element power	1.785 W
Voltaggio / Voltage	220-240 V
Frequenza / Frequency	50-60 Hz
Isolamento elettrico Electrical isolation	Classe II Class II
Grado di protezione elettrica Electrical class protection	IPX2

### Struttura / Construction

Scocca Casing	ABS
Filtro aria / Air filter	Non disponibile / Not available
Dimensioni (LxPxH) Dimensions (WxDxH)	262x165x305 mm
Peso / Weight	3 Kg

### Funzionamento / Operation

Attivazione / Activation	Pulsante o automatico (sensore ad infrarossi) Push button or automatic (infra-red detector)
Velocità dell'aria Air speed	80 Km/h (in uscita / output)
Volume d'aria / Air flow	160 m <sup>3</sup> /h
Rumorosità (da 1 M) Noise level (@ 1 M)	60 dB
Velocità asciugatura / Drying time	50 sec.

### Accreditamento / Accreditations

Marchi di qualità / Quality marks	CE, RoHS
-----------------------------------	----------

### Codici prodotto / Product code

<b>Qibli (accensione a pulsante) / Qibli (push button activation)</b>	
Bianco / White	<b>704125</b>
<b>Qibli (accensione a sensore) / Qibli (sensor activation)</b>	
Bianco / White	<b>704100</b>
Cromato / Chromed	<b>704101</b>
Satinato / Brushed	<b>704102</b>



## ALISÉ



Economico, compatto e silenzioso. Alisé è un tradizionale asciugamani ad aria calda alimentato da un motore ad induzione. Il dryer si aziona automaticamente, erogando un flusso d'aria tramite l'ampio bocchettone inferiore. Questo prodotto è la soluzione ideale per tutti coloro che desiderano un buon asciugamani elettrico pur avendo a disposizione un budget contenuto.

Cost-saving, compact and quiet. Alisé is a traditional hand dryer operated by a reliable brushless motor. Automatically activated by infrared sensor, the unit emits an hot air flow which passes through a very wide outlet located at the bottom of the dryer. Alisé offers a perfect balance between performance and aesthetic, for a very reasonable price.



**TECNOLOGIA AD INDUZIONE** - Incorpora un motore ad induzione che garantisce un notevole risparmio energetico. La tecnologia brushless, priva di elementi consumabili, comporta anche una minore manutenzione periodica.

**BRUSHLESS TECHNOLOGY** - Alisé is operated by a brushless motor. This technology offers incredible efficiency and increased power delivery, resulting in less wear and increased longevity of the dryer.



**ARIA CALDA ISTANTANEA** - All'interno del dryer è presente un elemento riscaldante, termicamente protetto, che consente di intiepidire il flusso d'asciugatura sin dai primi istanti d'utilizzo.

**INSTANT HOT AIR** - To offer a greater comfort in use, the dryer incorporates a heater that instantly warms the air during hand drying operations.



**ATTIVAZIONE AUTOMATICA** - Il tempo d'asciugatura è ottimizzato da un sistema automatico, con sensore a fotocellula. L'attivazione no-touch previene il contatto dell'utente con il dryer, garantendo massimi standard igienici.

**TOUCHLESS TECHNOLOGY** - Alisé automatically turns on when hands pass under the infrared sensors installed in the drying area. The touch-free activation promotes hand hygiene, without the risk of cross-contamination.



**TERMOSTATO DI SICUREZZA** - Qualora il sensore fosse oggetto di atti vandalici, la ventola venisse compromessa o la macchina si surriscaldasse, un termostato di sicurezza blocca automaticamente il funzionamento del dryer.

**OVERHEATING PROTECTION** - When infrared sensor is blocked for a long time, blower fan has a breakdown, or the dryer temperature exceeds safety limits, the overheating protection stops the dryer automatically.



**SUPER SILENZIOSO** - Con soli 54 dB emessi, è tra i più silenziosi asciugamani ad aria calda attualmente disponibili sul mercato. Una scelta ideale in tutti quei contesti in cui l'impatto acustico gioca un ruolo fondamentale.

**ULTRA QUIET** - Emitting just 54 dB of sound while operating, Alisé is one of the quietest hand dryers currently available on market. A great choice for noise-sensitive environments such as small restaurants.

Caratteristiche elettriche / Electrical specifications	
Numero motori / Number of motors	1
Tipo motore / Motor type	Motore AC a induzione Ac brushless motor
Potenza totale / Total power	1.800 W
Potenza motore / Motor power	100 W
Potenza resistenza Heating element power	1.700 W
Voltaggio / Voltage	220-240 V
Frequenza / Frequency	50-60 Hz
Isolamento elettrico Electrical isolation	Classe II Class II
Grado di protezione elettrica Electrical class protection	IPX1
Struttura / Construction	
Scocca / Casing	ABS
Filtro aria / Air filter	Non disponibile / Not available
Dimensioni (LxPxH) Dimensions (WxDxH)	235x215x215 mm
Peso / Weight	2,3 Kg
Funzionamento / Operation	
Attivazione / Activation	Automatico (sensori a infrarossi) Automatic infrared detector
Velocità dell'aria / Air speed	16 m/s (in uscita / output)
Volume d'aria / Air flow	160 m <sup>3</sup> /h
Rumorosità (da 1 M) Noise level (@ 1 M)	54 dB
Velocità asciugatura / Drying time	50 sec.
Accreditamento / Accreditations	
Marchi di qualità / Quality marks	CE, RoHS
Codici prodotto / Product code	
Bianco / White	<b>111500</b>
Grigio metallizzato / Silver gray	<b>111502</b>

ASCIUGACAPELLI

*HAIR DRYERS*





## ZEFIRO PRO HAIR



285 mm  
157 mm  
221 mm

### Asciugacapelli da parete

- Scocca in polipropilene o acciaio inox antivandalo
- Motore a spazzola con potenza totale 1.100 W
- Potenza motore: 550 W; Potenza resistenza: 550 W
- Voltaggio: 220-240 V - Frequenza: 50-60 Hz
- Doppio termostato di sicurezza incluso
- Accensione a pulsante posto sul lato della cover
- Spegnimento automatico dopo 40 sec.
- Tubo estensibile antistrappo (L: 60 - 120 cm)
- Isolamento/grado protezione elettrica: Classe II-IP23
- Ideale in location ad alto traffico d'utenza

### Wall-mounted hair dryer

- Dryer casing made from polypropylene or s.steel
- Brush motor - total power: 1.100 W
- Motor power: 550 W; Heater power: 550 W
- Voltage: 220 - 240 V; Frequency: 50 - 60 Hz
- Double overheating protection included
- Push button activation placed on the cover
- Auto turn-off in 40 seconds
- Flexible hose (L: 60 - 120 cm)
- Electrical isolation/class protection: Class II-IP23
- Ideal in high traffic areas



Pulsante accensione  
Activation button

Asciugacapelli da parete poliprop. bianco con tubo Wall-mounted hair dryer white polypropylene + hose	704550
Asciugacapelli da parete inox bianco con tubo Wall-mounted hair dryer white s.steel + hose	704560
Asciugacapelli da parete inox 304 brillante con tubo Wall-mounted hair dryer polished 304 s.steel + hose	704561
Asciugacapelli da parete inox 304 satinato con tubo Wall-mounted hair dryer brushed 304 s.steel + hose	704562





## HAMET



243 mm  
213 mm  
278 mm

### Asciugacapelli da parete

- Scocca antivandalo in acciaio porcellanato bianco
- Motore a spazzola con potenza totale 1.200 W
- Potenza motore: 200 W; Potenza resistenza: 1.000 W
- Voltaggio: 220-240 V - Frequenza: 50-60 Hz
- Doppio termostato di sicurezza incluso
- Accensione a pulsante
- Asciugatura temporizzata (30 sec.-3 min.)
- Tubo estensibile antistrappo (Ø: 46 mm; L: 1 mt)
- Isolamento / grado protezione elettrica: Classe I-IP20
- Ideale in location ad alto traffico d'utenza

### Wall-mounted hair dryer

- Dryer casing made from white vandal-proof steel
- Brush motor - total power: 1.200 W
- Motor power: 200 W; Heater power: 1.000 W
- Voltage: 220 - 240 V; Frequency: 50 - 60 Hz
- Double overheating protection included
- Push button activation
- Adjustable drying time (30 sec.-3 min.)
- Flexible hose (Ø: 46 mm; L: 1 mt)
- Electrical isolation / class protection: Class I-IP20
- Ideal in sport centres, spas and manufacturing facilities



Hamet bianco con tubo  
White Hamet with hose

704075

## HAMET SALI & SCENDI



243 mm  
213 mm  
278 mm

1000 mm  
150 mm  
300 mm

### Asciugacapelli da parete

- Scocca antivandalo in acciaio porcellanato bianco
- Motore a spazzola con potenza totale 2.400 W
- Potenza motore: 200 W; Potenza resistenza: 2.200 W
- Voltaggio: 220-240 V - Frequenza: 50-60 Hz
- Doppio termostato di sicurezza incluso
- Accensione a pulsante
- Asciugatura temporizzata (30 sec.-3 min.)
- Isolamento / grado protezione elettrica: Classe I-IP20
- Saliscendi in acciaio inox 304 brillante in opzione
- Ideale in centri sportivi, spa, spogliatoi d'impianti industriali

### Wall-mounted hair dryer

- Dryer casing made from white vandal-proof steel
- Brush motor - total power: 2.400 W
- Motor power: 200 W; Heater power: 2.200 W
- Voltage: 220 - 240 V; Frequency: 50 - 60 Hz
- Double overheating protection included
- Push button activation
- Adjustable drying time (30 sec.-3 min.)
- Electrical isolation / class protection: Class I-IP20
- Optional height adjuster from AISI 304 polished s.steel
- Ideal in sport centres, spas and manufacturing facilities



Hamet bianco  
White Hamet  
Saliscendi per Hamet  
Height adjuster for Hamet

704080

704085





## YUL PRO FIT



287 mm  
95 mm  
275 mm



287 mm  
95 mm  
275 mm



Supporto murale  
Wall bracket

### Asciugacapelli

- Involucro in ABS bianco o nero
- Motore a corrente alternata da 1.000 W max.
- Potenza motore: 100 W; Potenza resistenza: 900 W
- Voltaggio: 220-240 V - Frequenza: 50-60 Hz
- Accensione / spegnimento con pulsante a rilascio
- 2 combinazioni velocità / calore dell'aria
- Concentratore aria incluso
- Supporto murale nero incluso (versione "plus")
- Isolamento / grado protezione elettrica: Classe II
- Ideale in centri sportivi, palestre, etc

### Hair dryer

- Dryer casing made from white or black ABS
- Max. 1.000 W AC motor
- Motor power: 100 W; Heater power: 900 W
- Voltage: 220 - 240 V; Frequency: 50 - 60 Hz
- Activation / release by push button
- 2 air speed / temperature settings
- Air concentrator nozzle included
- Black wall mount base included ("plus" version)
- Electrical isolation / class protection: Class II
- Ideal in sport centers, gyms, etc.



Yul Pro Fit asciugacapelli bianco White Yul Pro Fit hair dryer	704025
Yul Pro Fit asciugacapelli nero Black Yul Pro Fit hair dryer	704026
Yul Pro Fit asciugacapelli bianco + supporto nero White Yul Pro Fit hair dryer + black wall base	704027
Yul Pro Fit asciugacapelli nero + supporto nero Black Yul Pro Fit hair dryer + black wall base	704028



## QIBLI HAIR



305 mm  
165 mm  
262 mm

### Asciugacapelli da parete

- Scocca in ABS bianco
- Motore a induzione da 1.200 W
- Voltaggio: 220-240 V - Frequenza: 50-60 Hz
- Termostato di sicurezza incluso
- Attivazione a pulsante
- Asciugatura temporizzata (30 sec.-3 min.)
- Isolamento / grado protezione elettrica: Classe II-IPX2
- Ideale in location a medio traffico d'utenza

### Wall-mounted hair dryer

- Dryer casing made from white ABS
- Brushless motor - total power: 1.200 W
- Voltage: 220 - 240 V; Frequency: 50 - 60 Hz
- Overheating protection included
- Push button activation
- Adjustable drying time (30 sec.-3 min.)
- Electrical isolation / class protection: Class II-IPX2
- Ideal in medium traffic areas



Asciugacapelli da parete ABS bianco Wall-mounted hair dryer white ABS	704070
--	--------



## YUL TUBO

517 mm  
93 mm  
140 mm



Preso rasoio  
Shaver Socket

### Asciugacapelli da parete

- Scocca in ABS bianco
- Motore a corrente alternata da 700 W max.
- Voltaggio: 220-240 V - Frequenza: 50-60 Hz
- Termostato di sicurezza incluso
- Accensione automatica al rilascio del tubo
- Spegnimento automatico dopo 5 minuti
- 2 combinazioni velocità/calore dell'aria
- Presa rasoio (220 / 110 V) inclusa nel supporto murale
- Isolamento / grado protezione elettrica: Classe II
- Ideale per uso alberghiero

### Wall-mounted hair dryer

- Dryer casing made from white ABS
- Max. 700 W AC motor
- Voltage: 220 - 240 V; Frequency: 50 - 60 Hz
- Overheating protection included
- Auto turn on when hose is released
- Auto turn off after 5 minutes
- 2 air speed / temperature settings
- Shaver socket (220 / 110V) included in the wall base
- Electrical isolation / class protection: Class II
- Ideal for hotel use



Asciugacapelli da parete ABS bianco con tubo  
Wall-mounted hair dryer white ABS with hose

704050

## YUL ATELIER

590 mm  
117 mm  
184 mm



### Asciugacapelli da parete

- Scocca in ABS bianco
- Motore a corrente alternata da 900 W max.
- Voltaggio: 220-240 V - Frequenza: 50-60 Hz
- Termostato di sicurezza incluso
- Accensione automatica al rilascio del tubo
- Spegnimento automatico dopo 10 minuti
- 3 combinazioni velocità/calore dell'aria
- Presa rasoio incorporata nel supporto murale
- Isolamento / grado protezione elettrica: Classe II
- Ideale per uso alberghiero

### Wall-mounted hair dryer

- Dryer casing made from white ABS
- Max. 900 W AC motor
- Voltage: 220 - 240 V; Frequency: 50 - 60 Hz
- Overheating protection included
- Auto turn on when hose is released
- Auto turn off after 10minutes
- 3 air speed / temperature settings
- Shaver socket included in the wall base
- Electrical isolation / class protection: Class II
- Ideal for hotel use



Asciugacapelli da parete ABS bianco con tubo  
Wall-mounted hair dryer white ABS with hose

704055



## YUL PRO

### Asciugacapelli con supporto murale

- Involucro in acciaio inox e ABS
- Motore a corrente alternata da 1.300 W max.
- Voltaggio: 220-240 V - Frequenza: 50-60 Hz
- Termostato sulla resistenza incluso
- Accensione / spegnimento con pulsante a rilascio
- 2 combinazioni velocità / calore dell'aria
- Supporto murale e/o presa rasoio in opzione
- Interruttore ON/OFF incluso nel supporto murale
- Isolamento / grado protezione elettrica: Classe II
- Ideale per uso alberghiero

### Wall-mounted hair dryer

- Dryer casing made from ABS and s.steel
- Max. 1.300 W professional AC motor
- Voltage: 220 - 240 V; Frequency: 50 - 60 Hz
- Overheating protection included
- Activation / release by push button
- 2 air speed / temperature settings
- Wall base and/or shaver socket as options
- ON/OFF switch included in the wall base
- Electrical isolation / class protection: Class II
- Ideal hotel use



Vers. base muro  
Wall base



260 mm  
110 mm  
218 mm

Vers. presa rasoio e base muro  
Wall base & shaver socket



295 mm  
145 mm  
218 mm

Versione classica  
Standard version



218 mm  
90 mm  
260 mm



Yul Pro con base a muro Yul Pro with wall base	704010
Yul Pro con base a muro e presa rasoio Yul Pro wall base and shaver socket	704011
Yul Pro versione classica (cavo 3 M) Yul Pro standard version (3 M linear cable)	704012



## YUL PRO ABS

### Asciugacapelli

- Involucro in ABS bianco o nero
- Motore a corrente alternata da 1.800 W max.
- Voltaggio: 220-240 V - Frequenza: 50-60 Hz
- Accensione / spegnimento con pulsante a rilascio
- 2 combinazioni velocità / 3 combinazioni calore aria
- Concentratore aria incluso
- Supporto murale in ottone cromato in opzione
- Isolamento / grado protezione elettrica: Classe II
- Ideale per uso alberghiero

### Hair dryer

- Dryer casing made from white or black ABS
- Max. 1.800 W professional AC motor
- Voltage: 220 - 240 V; Frequency: 50 - 60 Hz
- Activation / release by push button
- 2 air speed / 3 air temperature settings
- Air concentrator included
- Chromed brass wall holder as option
- Electrical isolation / class protection: Class II
- Ideal for hotel use

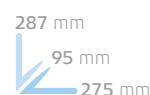
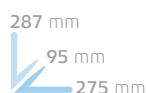

Supporto murale  
Wall bracket

Yul Pro bianco White Yul Pro	704020
Yul Pro nero Black Yul Pro	704021
Supporto murale Wall base	704029



## PHONETTE



215 mm  
105 mm  
230 mm

### Asciugacapelli con supporto murale

- Involucro e supporto in ABS bianco con finitura cromata
- Motore a magneti permanenti da 1.500 W max.
- Voltaggio: 220-240 V - Frequenza: 50-60 Hz
- Termostato di sicurezza sulla resistenza
- Accensione / spegnimento con pulsante a rilascio
- 3 combinazioni velocità/calore dell'aria
- Presa rasoio (220/110 V) inclusa nel supporto murale
- Interruttore ON/OFF incluso nel supporto murale
- Grado protezione elettrica: Classe II-IP21

### Wall-mounted hair dryer

- Dryer and wall-base casing made from white ABS
- Max. 1.500 W permanent magnet motor
- Voltage: 220 - 240 V; Frequency: 50 - 60 Hz
- Overheating protection included
- Activation / release by push button
- 3 air speed / temperature settings
- Shaver socket (220/110 V) included in the wall base
- ON/OFF safety switch button in the wall base
- Protection level: Class II-IP21



Phonette presa rasoio  
Phonette shaver socket

704003

## YUL COMFORT



220 mm  
140 mm  
250 mm

### Asciugacapelli con supporto murale

- Involucro e supporto in ABS bianco con finitura cromata
- Motore a magneti permanenti da 1.800 W max.
- Voltaggio: 220-240 V - Frequenza: 50-60 Hz
- Termostato di sicurezza sulla resistenza
- Accensione / spegnimento con pulsante a rilascio
- 3 combinazioni velocità / calore dell'aria
- Interruttore ON/OFF incluso nel supporto murale
- Grado protezione elettrica: Classe II
- Ideale per uso alberghiero

### Wall-mounted hair dryer

- Dryer and wall-base casing made from white ABS
- Max. 1.800 W permanent magnet motor
- Voltage: 220 - 240 V; Frequency: 50 - 60 Hz
- Overheating protection included
- Activation / release by push button
- 3 air speed/temperature settings
- ON/OFF safety switch button on the wall base
- Protection level: Class II
- Ideal for hotel use



Yul Comfort  
Yul Comfort

704004





## YUL SPACE



190 mm  
140 mm  
270 mm



LxPxH / LxDxH  
145x140x190 mm

### Asciugacapelli con manico pieghevole e supporto murale

- Involucro e supporto in ABS bianco con finitura cromata
- Motore a magneti permanenti da 1.650 W max.
- Voltaggio: 220-240 V - Frequenza: 50-60 Hz
- Termostato di sicurezza sulla resistenza incluso
- Accensione / spegnimento con pulsante a rilascio
- 3 combinazioni velocità/calore dell'aria
- Manico pieghevole per ridurre l'ingombro
- Interruttore ON/OFF incluso nel supporto murale
- Isolamento/grado protezione elettrica: Classe II
- Ideale per uso alberghiero

### Wall-mounted hair dryer with foldable handle

- Dryer and wall-base casing made from white ABS
- 1.650 W permanent magnet motor
- Voltage: 220 - 240 V; Frequency: 50 - 60 Hz
- Overheating protection included
- Activation/release by push button
- 3 air speed/temperature settings
- Foldable handle to save space
- ON/OFF switch included in the wall base
- Electrical isolation/class protection: Class II
- Ideal hotel use



Yul Space  
Yul Space

704005

## YUL BASIC

Supporto frontale  
Front holder



150 mm  
147 mm  
91 mm

Supporto con presa rasoio  
Wall-base with shaver socket



221 mm  
112 mm  
200 mm

### Asciugacapelli con supporto murale

- Involucro e supporto murale in ABS bianco
- Motore a magneti permanenti da 1.200 W max.
- Voltaggio: 220-240 V - Frequenza: 50-60 Hz
- Termostato di sicurezza sulla resistenza
- Accensione / spegnimento con pulsante a rilascio
- 2 combinazioni velocità / calore dell'aria
- Interruttore ON/OFF incluso nel supporto murale
- Grado protezione elettrica: Classe II

### Wall mounted hair dryer

- Dryer and wall-base casing made from white ABS
- 1.200 W permanent magnet motor
- Voltage: 220 - 240 V; Frequency: 50 - 60 Hz
- Overheating protection included
- Activation / release by push button
- 2 air speed/air temperature settings
- ON/OFF safety switch button in the wall base
- Electrical isolation / class protection: Class II



Supporto laterale  
Side holder



193 mm  
102 mm  
200 mm

Yul Basic frontale

Front basic Yul

704000

Yul Basic laterale con presa  
Yul Basic with shaver socket

704001

Yul Basic laterale  
Side Yul Basic

704002



## ATTREZZATURE PER SPAZI INTERNI EQUIPMENT FOR INDOOR AREAS

P.  
**176**



**GETTACARTE RACCOLTA  
DIFFERENZIATA  
RECYCLING WASTE BINS**

P.  
**199**



**CESTINI  
PAPER BINS**

P.  
**188**



**CONTENITORI RIFIUTI  
SPECIALI  
SPECIAL WASTES CONTAINERS**

P.  
**203**



**POSACENERE GETTACARTE  
ASHBINS**

P.  
**189**

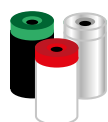

**GETTACARTE  
AUTO-ESTINGUENTI  
SELF EXTINGUISHING  
WASTE BINS**

P.  
**207**



**PORTAOMBRELLI  
UMBRELLA STANDS**

P.  
**192**



**ETICHETTE RACCOLTA  
DIFFERENZIATA  
WASTE SORTING STICKERS**

P.  
**208**



**DISTRIBUTORE BUSTE  
COPRI-OMBRELLO  
UMBRELLA WRAPPER**

P.  
**194**



**GETTACARTE PUSH  
PUSH WASTE BINS**

P.  
**209**



**PANCHE SALE D'ATTESA  
RECEPTION SEATINGS**

P.  
**196**



**GETTACARTE BASCULANTI  
SWING WASTE BINS**

P.  
**210**

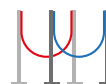

**SISTEMI DIVISORI  
CROWD CONTROL POSTS**

P.  
**197**

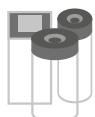

**GETTACARTE TRASPARENTI  
TRANSPARENT WASTE BINS**

P.  
**214**



**PITTOGRAMMI  
PICTOGRAMS**

P.  
**198**



**GETTACARTE MURALI  
WALL MOUNTED WASTE BINS**

P.  
**216**



**APPENDIABILI  
COAT STAND**





## VERONA

### Gettacarte per la raccolta differenziata

- Struttura in lamiera zincata
- Verniciatura con polvere poliestere (RAL 7021)
- 3 o 4 aperture frontali di conferimento, con fasce adesive colorate
- Ospita 3 supporti ferma-sacco in filo d'acciaio (3x40 L) - **VERONA**
- Ospita 4 supporti ferma-sacco in filo d'acciaio (4x40 L) - **VERONA PLUS**
- Anta frontale con chiusura a chiave triangolare
- Zoccolo in Tubolare 50x50 con predisposizione per fissaggio a terra
- In opzione, etichette pre-fustellate in vinile per la differenziata (p. 193)

### Recycling station

- Galvanized steel case
- Polyester powder coating (RAL 7021)
- 3 or 4 front openings, complete with colored stickers
- Holds three steel wire sack holders (3 x 40 L) - **VERONA**
- Holds four steel wire sack holders (4 x 40 L) - **VERONA PLUS**
- Front door with triangular key lock
- Tubular 50x50 plinth with provision for ground fixing
- As option, PVC pre-cut adhesive labels for waste sorting (p.193)



DISPONIBILE IN AR SU MEDIAL APP  
AVAILABLE IN AR ON MEDIAL APP



120  
L

3 Flussi / 3 Streams



1094 mm  
326 mm  
1018 mm

Misure apertura di conferimento  
Front opening size

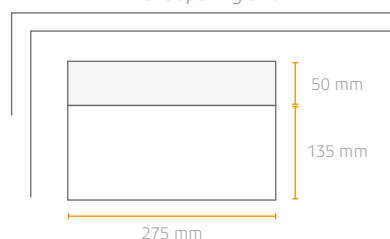

Adesivi per la  
raccolta differenziata  
acquistabili  
separatamente  
*Waste sorting  
stickers sold  
separately*



Reggisacco interno  
Inner sack holders

## VERONA PLUS

160  
L

4 Flussi / 4 Streams



1094 mm  
376 mm  
1018 mm

Misure apertura di conferimento  
Front opening size

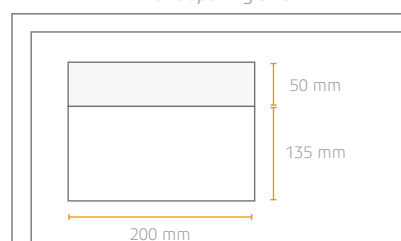

Adesivi per la  
raccolta differenziata  
acquistabili  
separatamente  
*Waste sorting  
stickers sold  
separately*



Posacenere VERONA  
VERONA Ashtray  
REF. 789390  
(p.227)



VERONA - Gettacarte per differenziata 120 L (3x40 L)  
VERONA - Recycling station 120 L (3x40 L)

789300

VERONA PLUS - Gettacarte per differenziata nero 160 L (4x40)  
VERONA PLUS - Black recycling station 160 L (4x40)

789301

VERONA - Posacenere murale in opzione  
VERONA - Mural ashtray (optional)

789390





## MALTA

### Gettacarte per la raccolta differenziata

- Struttura in acciaio inox satinato
- Tre sportelli push in inox con segnaletica del tipo di rifiuto
- Segnaletica dello sportello personalizzabile a laser su richiesta
- Cornice in metallo verniciato grigio
- Include tre reggisacchi interni in filo di acciaio zincato
- Anta frontale con chiusura a chiave triangolare
- Zoccolo in Tubolare 50x50 con predisposizione per fissaggio a terra
- In opzione, etichette pre-fustellate in vinile per la differenziata (p. 193)

### Recycling station

- Brushed stainless steel case
- Three s.steel push flaps marked with recycling symbols
- Flaps can be customized with special icons on request
- Metal coated frames
- Includes three inner sack holders from galvanized steel
- Front door opening with metal lock and triangular key
- Tubular 50x50 plinth with provision for ground fixing
- As option, PVC pre-cut adhesive labels for waste sorting (p.193)

3x40  
L



Adesivi per la raccolta differenziata  
acquistabili separatamente  
Waste sorting stickers  
sold separately

960 mm  
390 mm  
790 mm

Segnaletica sportelli push personalizzabile su richiesta  
Flaps can be customized with special icons on request



Reggisacchi interni  
Inner sack holders



Sportelli personalizzabili  
Customizable push flaps



Gettacarte per la raccolta differenziata 3x40 L  
Recycling station 3x40 L

789075





## KOALA

### Gettacarte per la raccolta differenziata

- Struttura in acciaio inox satinato o metallo verniciato
- Da utilizzare con un contenitore interno (non compreso)
- Anta frontale con chiusura a chiave triangolare
- Cornici colorate per la raccolta differenziata
- Pittogramma con segnaletica del tipo di rifiuto
- Piedi regolabili (altezza max. 5 cm)
- In opzione, etichette pre-fustellate in vinile per la differenziata (p. 193)
- In opzione, kit quattro ruote Ø 40 mm (2 ruote con freno)

### Recycling station

- Brushed stainless steel or coated steel
- To be used with inner waste container (not included)
- Front door opening with metal lock and triangular key
- Coloured frames to encourage waste separation
- Sign with recycling symbols
- Adjustable feet (5 cm max. height)
- As option, PVC pre-cut adhesive labels for waste sorting (p.193)
- As option, four wheels Ø 40 mm as option (2 with breaks)



Ospita un contenitore da 120 L (ref. 766610) | Holds a 120 L waste container (ref. 766610)

120  
L



1180 mm  
585 mm  
580 mm

Varianti colore | Colors available

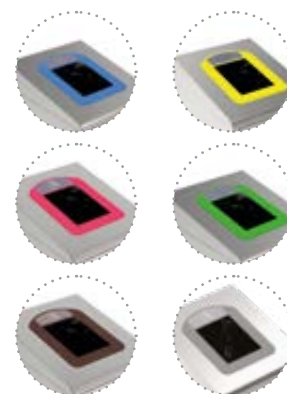

Ospita un secchio da 60 L (ref. 114200) | Holds a 60 L waste bucket (ref. 114200)

60  
L



760 mm  
485 mm  
400 mm



Composizioni modulari / Modular design



Struttura in metallo verniciato nero 120 L <i>Black coated steel case 120 L</i>	<b>789051</b>
Contenitore in plastica 120 L <i>Plastic waste container 120 L</i>	<b>766610</b>
Struttura in inox satinato 60 L <i>Brushed s.steel case 60 L</i>	<b>789020</b>
Struttura in metallo verniciato nero 60 L <i>Black coated steel case 60 L</i>	<b>789021</b>
Secchio in plastica 60 L <i>Plastic liner 60 L</i>	<b>114200</b>
Cornice grigia <i>Grey frame</i>	<b>789032</b>
Cornice blu <i>Blue frame</i>	<b>789035</b>
Cornice gialla <i>Yellow frame</i>	<b>789036</b>
Cornice rossa <i>Red frame</i>	<b>789037</b>
Cornice verde <i>Green frame</i>	<b>789038</b>
Cornice marrone <i>Brown frame</i>	<b>789039</b>
Insero simbolo plastica <i>Plastic recycling sign</i>	<b>789041</b>
Insero simbolo carta <i>Paper recycling sign</i>	<b>789042</b>
Insero simbolo vetro <i>Glass recycling sign</i>	<b>789043</b>
Insero simbolo generico <i>Mixed wastes sign</i>	<b>789044</b>
Insero simbolo metallo <i>Metal recycling sign</i>	<b>789045</b>
Insero simbolo metallo-plastica <i>Metal-plastic recycling sign</i>	<b>789046</b>
Insero simbolo organico <i>Food waste recycling sign</i>	<b>789047</b>
Kit quattro ruote Ø 40 mm (2 con freno) <i>Four wheels kit Ø 40 mm (2 w/breaks)</i>	<b>789099</b>



## RUBIK EVO

### Gettacarte per la raccolta differenziata

- Corpo e coperchio in metallo verniciato
- Coperchi colorati per incentivare la raccolta differenziata
- Etichette "skyline" colorate già applicate
- Sistema reggisacco integrato
- Apertura mediante sportello superiore
- Ideale per creare isole ecologiche
- 4 piedini regolabili in altezza
- In opzione, kit quattro ruote Ø 40 mm (2 ruote con freno)
- In opzione, etichette pre-fustellate in vinile per la differenziata (p. 193)

### Recycling waste bin

- Housing and lid from powder-coated steel
- Coloured lids to encourage waste separation
- Pre-applied colored "skyline" stickers
- Inner sack holder
- Opening by upper door
- Ideal to create recycling stands
- 4 height-adjustable feet
- As option, four wheels Ø 40 mm as option (2 wheels with break)
- As option, PVC pre-cut adhesive labels for waste sorting (p.193)

80  
L



795 mm  
425 mm  
405 mm



Con adesivi / With stickers



Composizioni modulari / Modular design

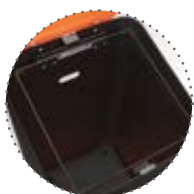

Reggisacco interno  
Inner sack holder



Apertura 160x200 mm  
Opening 160x200 mm



Kit 4 ruote (2 con freno)  
4 wheels kit (2 w/breaks)

Gettacarte per la raccolta differenziata testa grigia 80 L Recycling waste bin grey lid 80 L	789292
Gettacarte per la raccolta differenziata testa bianca 80 L Recycling waste bin white lid 80 L	789293
Gettacarte per la raccolta differenziata testa blu 80 L Recycling waste bin blue lid 80 L	789295
Gettacarte per la raccolta differenziata testa gialla 80 L Recycling waste bin yellow lid 80 L	789296
Gettacarte per la raccolta differenziata testa rossa 80 L Recycling waste bin red lid 80 L	789297
Gettacarte per la raccolta differenziata testa verde 80 L Recycling waste bin green lid 80 L	789298
Kit quattro ruote Ø 40 mm (2 con freno) Four wheels kit Ø 40 mm (2 w/breaks)	789099





## RUBIK EVO

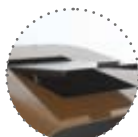

APERTURA 172x180 mm  
OPENING 172 x 180 mm

80  
L



795 mm  
425 mm  
405 mm



### Gettacarte con sportello per la raccolta differenziata

- Corpo e coperchio in metallo verniciato
- Sportello richiudibile
- Etichette "skyline" colorate già applicate
- Sistema reggisacco integrato
- Apertura mediante sportello superiore
- Ideale per rifiuti organici
- 4 piedini regolabili in altezza
- In opzione, kit quattro ruote Ø 40 mm (2 ruote con freno)
- In opzione, etichette pre-fustellate in vinile per la differenziata

### Recycling waste bin with foldable door

- Housing and lid from powder-coated steel
- Foldable door
- Pre-applied colored "skyline" stickers
- Inner sack holder
- Opening by upper door
- Ideal for organic waste
- 4 height-adjustable feet
- As option, four wheels Ø 40 mm as option (2 wheels with break)
- As option, PVC pre-cut adhesive labels for waste sorting



Con adesivo / With sticker



Reggisacco interno  
Inner sack holder



Kit 4 ruote (2 con freno)  
4 wheels kit (2 w/breaks)

Gettacarte per la raccolta differenziata testa marrone 80 L  
Recycling waste bin brown lid 80 L

789299





## ROXY

### Gettacarte per la raccolta differenziata

- Struttura in metallo verniciato
- **Versione "Classic" con apertura sportello superiore**
  - Sistema reggisacco integrato
- **Versione "Door" con apertura porta frontale**
  - Reggisacco interno in filo d'acciaio zincato
  - Serratura con chiave triangolare
- Ideale per creare isole ecologiche
- 4 piedini regolabili in altezza
- In opzione, kit quattro ruote Ø 40 mm (2 ruote con freno)
- In opzione, etichette pre-fustellate in vinile per la differenziata (p. 193)

### Recycling waste bin

- Housing and lid from powder-coated steel
- **"Classic" version: opening by upper door**
  - Inner sack holder
- **"Door" version: opening by frontal door**
  - Galvanised steel wire inner heel holder
  - Lock with triangular key
- Ideal to create recycling stands
- 4 height-adjustable feet
- Four wheels Ø 40 mm as option (2 wheels with break)
- As option, PVC stickers for waste sorting (p.193)



DISPONIBILE IN AR SU MEDIAL APP  
AVAILABLE IN AR ON MEDIAL APP



80  
L



### Versione "Classic" / "Classic" version



785 mm  
450 mm  
400 mm

### Varianti colore / Colors available



NEW



Apertura 172x180 Mm  
Opening 172 X 180 Mm



Reggisacco interno  
Inner sack holder



Apertura 160x200 mm  
Opening 160x200 mm



Kit 4 ruote (2 con freno)  
4 wheels kit (2 w/breaks)

Gettacarte "ROXY CLASSIC" grigio-nero 80 L "ROXY CLASSIC" recycling waste bin grey-black 80 L	789221
Gettacarte "ROXY CLASSIC" bianco-nero 80 L "ROXY CLASSIC" recycling waste bin white-black 80 L	789231
Gettacarte "ROXY CLASSIC" blu-nero 80 L "ROXY CLASSIC" recycling waste bin blue-black 80 L	789251
Gettacarte "ROXY CLASSIC" giallo-nero 80 L "ROXY CLASSIC" recycling waste bin yellow-black 80 L	789261
Gettacarte "ROXY CLASSIC" rosso-nero 80 L "ROXY CLASSIC" recycling waste bin red-black 80 L	789271
Gettacarte "ROXY CLASSIC" verde-nero 80 L "ROXY CLASSIC" recycling waste bin green-black 80 L	789281
Gettacarte "ROXY CLASSIC" marrone-nero 80 L "ROXY CLASSIC" recycling waste bin brown-black 80 L	789241
Kit quattro ruote Ø 40 mm (2 con freno) Four wheels kit Ø 40 mm (2 w/breaks)	789099





Composizioni modulari • In opzione etichette adesive per la differenziata  
Modular design • As option, PVC pre-cut adhesive labels for waste sorting



Apertura frontale con reggisacco interno  
Frontal opening with inner sack holder



Varianti colore / Colors available



Versione "Door" / "Door" version

80 L

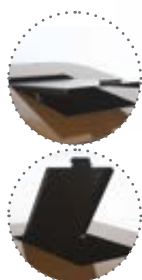

Apertura 172x180 Mm  
Opening 172 X 180 Mm



785 mm  
450 mm  
400 mm



Secchio in opzione  
Bucket in option

789209



Kit 4 ruote (2 con freno)  
4 wheels kit (2 w/breaks)



Serratura  
Lock

Gettacarte "ROXY DOOR" grigio-nero 80 L "ROXY DOOR" recycling waste bin grey-black 80 L	789222
Gettacarte "ROXY DOOR" bianco-nero 80 L "ROXY DOOR" recycling waste bin white-black 80 L	789232
Gettacarte "ROXY DOOR" blu-nero 80 L "ROXY DOOR" recycling waste bin blue-black 80 L	789252
Gettacarte "ROXY DOOR" giallo-nero 80 L "ROXY DOOR" recycling waste bin yellow-black 80 L	789262
Gettacarte "ROXY DOOR" rosso-nero 80 L "ROXY DOOR" recycling waste bin red-black 80 L	789272
Gettacarte "ROXY DOOR" verde-nero 80 L "ROXY DOOR" recycling waste bin green-black 80 L	789282
Gettacarte "ROXY DOOR" marrone-nero 80 L "ROXY DOOR" recycling waste bin brown-black 80 L	789242
Kit quattro ruote Ø 40 mm (2 con freno) Four wheels kit Ø 40 mm (2 w/breaks)	789099



## BOB COLOR

### Gettacarte

- Corpo e coperchio in metallo verniciato
- Profili colorati per incentivare la raccolta differenziata
- Sistema reggisacco integrato
- Installazione su piano d'appoggio
- In opzione, gancio per creare isole ecologiche (cod. 790408)
- In opzione, etichette pre-fustellate in vinile per la differenziata (p. 193)

### Waste bin

- Housing and lid from powder-coated steel
- Coloured lids to encourage waste separation
- Inner sack holder
- Freestanding installation
- As option, clip to create recycling stands (cod. 790408)
- As option, PVC pre-cut adhesive labels for waste sorting (p.193)

60  
L



750 mm  
230 mm  
350 mm

42  
L



700 mm  
200 mm  
300 mm



DISPONIBILE IN AR SU MEDIAL APP  
AVAILABLE IN AR ON MEDIAL APP



42  
L

Cornice / Frame  
304x200mm  
Apertura / Opening  
210x105mm



60  
L

Cornice / Frame  
355x235mm  
Apertura / Opening  
210x105mm



Adesivi per la raccolta differenziata acquistabili separatamente  
Waste sorting stickers sold separately



Composizioni modulari /  
Modular design



Varianti colore / Colors available



Staffa di connessione  
Linking clips for buckets

790408

	42 L		60 L	
	Corpo 42 L Bucket 42 L	Coperchio 42 L Lid 42 L	Corpo 60 L Bucket 60 L	Coperchio 60 L Lid 60 L
Nero Black	790401		790402	
Grigio Grey		790412		790432
Blu Blue		790415		790435
Giallo Yellow		790416		790436
Rosso Red		790417		790437
Verde Green		790418		790438



42 L

NEW

NEW

60 L



700 mm  
200 mm  
300 mm

750 mm  
230 mm  
350 mm

42 L

Cornice / Frame  
304x200mm

Sportello / Door  
222x147mm

Apertura / Opening  
210x105mm



60 L

Cornice / Frame  
355x235mm

Sportello / Door  
222x147mm

Apertura / Opening  
210x105mm



42 L

60 L

Versione marrone con sportello  
Brown version with door

790414

790434





## MULTIFLUX

### Pattumiere a pedale per la raccolta differenziata

- Struttura in acciaio inox satinato anti-traccia
- Coperchio in polipropilene e acciaio inox
- Sistema di chiusura del coperchio rallentato e silenzioso
- Maniglie laterali per un facile spostamento
- Secchi interni in polipropilene
- Base in ABS

### Recycling pedal bin

- Fingerprint-proof brushed stainless steel body
- Silent close lid in polypropylene and stainless steel
- Tuck-away bag hiding system
- Built-in lateral handles for easy handling
- Polypropylene inner buckets with handle
- Non-scratch ABS base



2x12  
L



430 mm  
382 mm  
405 mm



3x12  
L



430 mm  
382 mm  
593 mm



2x30  
L



636 mm  
459 mm  
495 mm



Due secchi interni  
Two inside buckets



Tre secchi interni  
Three inside buckets

Pattumiera a pedale per la differenziata 2x12 L  
Recycling pedal bin 2x12 L

106503

Pattumiera a pedale per la differenziata 3x12 L  
Recycling pedal bin 3x12 L

106500

Pattumiera a pedale per la differenziata 2x30 L  
Recycling pedal bin 2x30 L

106505

## MULTIFLUX



### Pattumiera a pedale per la raccolta differenziata

- Struttura in acciaio inox satinato anti-traccia
- Coperchi in polipropilene
- Sistema di chiusura del coperchio rallentato e silenzioso
- Apertura flussi separata; flussi azionabili singolarmente
- Maniglie laterali per un facile spostamento
- Secchi interni in polipropilene con maniglia
- Base antiribaltamento in ABS

### Recycling pedal bin

- Fingerprint-proof brushed stainless steel body
- Silent close lid in polypropylene and stainless steel
- Tuck-away bag hiding system
- Opening separate streams; individually operable flows
- Built-in lateral handles for easy handling
- Polypropylene inner buckets with handle
- Anti-tipping ABS base



Apertura flussi  
separata  
Opening separate  
streams

3x15  
L



430 mm  
370 mm  
585 mm



Tre secchi interni  
Three inside buckets



Maniglie di trasporto  
Lateral handles

Pattumiera a pedale per la differenziata 3x15 L  
Recycling pedal bin 3x15 L

112500





## STATION

### Gettacarte per la raccolta differenziata

- Struttura in metallo verniciato e ghiera in inox satinato
- **STATION DUO:**  
due secchi interni in acciaio galvanizzato  
capacità secchio: 50 L / capacità totale: 100 L
- **STATION TRIO:**  
tre secchi interni in acciaio galvanizzato  
capacità secchio: 35 L / capacità totale: 105 L
- In opzione KIT 5 etichette adesive colorate (REF. 701093)
- Base in gomma

### Recycling waste bin

- Coated steel body and brushed s.steel lid
- **STATION DUO:**  
two inner buckets in galvanized steel  
bucket capacity: 50 L / total capacity: 100 L
- **STATION TRIO:**  
three inner buckets in galvanized steel  
bucket capacity: 35 L / total capacity: 105 L
- Optional KIT 5 coloured adhesive labels (REF. 701093)
- Plastic bottom ring



## STATION DUO

2x50  
L



750 mm  
450 mm

## STATION TRIO

3x35  
L



750 mm  
450 mm



Gettacarte nero con secchi metallo galvaniz. 2x50 L Black recycling bin + galva steel buckets 2x50 L	<b>790840</b>
Gettacarte nero con secchi metallo galvaniz. 3x35 L Black recycling bin + galva steel buckets 3x35 L	<b>790830</b>
Kit etichette adesive colorate (x5) Colorful adhesive label kit (x5)	<b>701093</b>





## CASPER

### Contenitore per rifiuti differenziati

- Coperchio e base in metallo verniciato
- Tubo in policarbonato trasparente
- Disco assorbente sul fondo
- Rapido controllo del contenuto
- Etichette autoadesive in opzione

### Recycling waste bin

- Lid and base from coated steel
- Transparent tube from polycarbonate
- Absorbent round disc at the base
- Easy to check the content
- Stickers sold separately



Apertura | Opening



1000 mm  
270 mm



### Etichette / Stickers



150 mm  
350 mm



Contenitore verde 10 L Green bin 10 L	774500
Contenitore grigio 10 L Grey bin 10 L	774502
Etichetta pile esauste Exhausted batteries sticker	774510
Etichetta lampadine Lamps sticker	774511
Etichetta tappi Caps sticker	774512
Etichetta strumenti di scrittura Writing instruments sticker	774513
Etichetta cartucce stampanti inkjet Inkjet cartridges sticker	774514

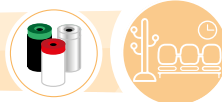

## GRISÙ VIP

### Gettacarte auto-estinguenti

- Contenitore in metallo verniciato con polvere epossidica
- Coperchio in acciaio inox satinato con bordo ribassato (H 100 mm)
- Testa soffocante per bloccare la propagazione del fuoco
- Base in gomma anti-graffio
- Vers. 50 e 90 L certificate da CNPP

### Auto-extinguishing waste bins

- Housing made from powder-coated steel
- Lid made of brushed s.steel, with 100 mm lateral edge
- Special fire-extinguishing lid prevents fire from spreading
- Non-scratch rubber base ring
- CNPP certified (50 and 90 L versions)



Principio di autoestinzione  
Flame-extinguishing process



Auto-estinguente  
Self extinguishing

Gettacarte metallo nero testa inox 30 L Black steel waste bin with s.steel lid 30 L	<b>770053</b>
Gettacarte metallo nero testa inox 50 L Black steel waste bin with s.steel lid 50 L	<b>770051</b>
Gettacarte metallo nero testa inox 90 L Black steel waste bin with s.steel lid 90 L	<b>770052</b>

## GRISÙ VIP COLOR

### Gettacarte auto-estinguenti

- Contenitore in metallo verniciato con polvere epossidica
- Coperchio con bordo ribassato (H 100 mm)
- Testa soffocante per bloccare la propagazione del fuoco
- Base in gomma anti-graffio
- Certificato dal CNPP

### Auto-extinguishing waste bins

- Housing made from powder-coated steel
- Lid with lateral edge H 100 mm
- Special fire-extinguishing lid prevents fire from spreading
- Non-scratch rubber base ring
- CNPP certified



### Varianti colore / Colors available



Principio di autoestinzione  
Flame-extinguishing process



Auto-estinguente  
Self extinguishing

	Nero Black	Bianco White	Grigio Grey	Blu Blue	Giallo Yellow	Rosso Red	Verde Green
Corpo 50 L Bucket 50 L	<b>770501</b>	<b>770503</b>					
Coperchio 50 L Lid 50 L	<b>770064</b>	<b>770067</b>	<b>770562</b>	<b>770565</b>	<b>770566</b>	<b>770567</b>	<b>770568</b>
Corpo 90 L Bucket 90 L	<b>770901</b>	<b>770903</b>					
Coperchio 90 L Lid 90 L	<b>770065</b>	<b>770068</b>	<b>770962</b>	<b>770965</b>	<b>770966</b>	<b>770967</b>	<b>770968</b>

## GRISÙ

### Gettacarte auto-estinguenti

- Acciaio inox satinato o metallo verniciato con polvere epossidica
- Testa soffocante per bloccare la propagazione del fuoco
- Base in gomma antigraffio
- Certificato dal CNPP

### Auto-extinguishing waste bins

- Brushed stainless steel or powder-coated steel
- Special fire-extinguishing lid prevents fire from spreading
- Non-scratch rubber base ring
- CNPP certified



Varianti colore / Colors available



Principio di autoestinzione  
Flame-extinguishing process



Auto-estinguente  
Self extinguishing

	15 L	30 L	50 L	90 L	120 L
Gettacarte auto-estinguente inox satinato Auto-extinguishing brushed s.steel waste bin	770000	770030	770010	770020	<del>770040</del>
Gettacarte auto-estinguente nero Auto-extinguishing black steel waste bin	770001	770031	770011	770021	770041
Gettacarte auto-estinguente grigio Auto-extinguishing grey steel waste bin	770002	770032	770012	770022	770042
Gettacarte auto-esting. doppia verniciatura simil-inox Auto-extinguishing silver double coating waste bin			772052		

## GRISÙ COLOR

### Gettacarte auto-estinguenti con coperchio colorato

- Contenitore in metallo verniciato nero con polvere epossidica
- Testa soffocante per bloccare la propagazione del fuoco
- Base in gomma anti-graffio
- Certificato dal CNPP

### Auto-extinguishing waste bins with colored lid

- Housing made from powder-coated steel
- Special fire-extinguishing lid prevents fire from spreading
- Non-skid rubber base
- CNPP certified



Varianti colore / Colors available



Principio di autoestinzione  
Flame-extinguishing process



Auto-estinguente  
Self extinguishing

	Nero-Grigio Black-Grey	Nero-Blu Black-Blue	Nero-Giallo Black-Yellow	Nero-Rosso Black-Red	Nero-Verde Black-Green
50 L	770014	770015	770016	770017	770018
90 L	770024	770025	770026	770027	770028

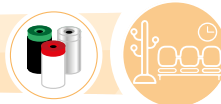

## TRISÙ

### Isola ecologica auto-estinguente

- Isola ecologica composta da tre gettacarte auto-estinguenti
- Struttura in metallo verniciato con polveri epossidiche
- Coperchio auto-soffocante per bloccare la propagazione del fuoco
- Capacità: 3x50 L o 3x70 L

### Recycling auto-extinguishing station

- The station comes with 3 auto-extinguishing bins
- Powder epoxy coated steel body and lid
- Self-extinguishing lid (designed to prevent fire from spreading)
- Sizes: 3x50 L or 3x70 L

3x50  
L



590 mm  
400 mm  
1010 mm



Principio di autoestinzione  
Flame-extinguishing process



Auto-estinguente  
Self extinguishing



DISPONIBILE IN AR SU MEDIAL APP  
AVAILABLE IN AR ON MEDIAL APP



3x70  
L



840 mm  
400 mm  
1010 mm

Isola ecologica auto-estinguente 3x50 L  
Self extinguishing recycling station 3x50 L

770351

Isola ecologica auto-estinguente 3x70 L  
Self extinguishing recycling station 3x70 L

770371

## GRISÙ MURALE

### Gettacarte auto-estinguenti murali

- Contenitore in metallo verniciato con polvere epossidica
- Coperchio in metallo verniciato con bordo ribassato (H 100 mm)
- Testa soffocante per bloccare la propagazione del fuoco
- Staffa in metallo verniciato per aggancio murale
- Certificato dal CNPP
- Viteria non inclusa

### Wall mounted auto-extinguishing waste bins

- Housing made from powder-coated steel
- Lid made from powder-coated steel, with H 100 mm lateral edge
- Special fire-extinguishing lid prevents fire from spreading
- Wall mounting bracket from coated steel
- CNPP certified
- Screws not included

50  
L

Ø 140 mm



605 mm  
345 mm  
348 mm



Principio di autoestinzione  
Flame-extinguishing process



Auto-estinguente  
Self extinguishing

Varianti colore / Colors available



Gettacarte auto-estinguente murale nero 50 L  
Auto-extinguishing waste bin black steel 50 L

770211

Gettacarte auto-estinguente murale grigio 50 L  
Auto-extinguishing waste bin grey steel 50 L

770212

Gettacarte auto-estinguente murale bianco 50 L  
Auto-extinguishing waste bin white steel 50 L

770213





## STIK

### Etichette autoadesive

- Etichette adesive pre-fustellate in PVC con finitura lucida
- Applicabili su tutti i tipi di superfici, sia in plastica che metallo
- Utili per organizzare in modo efficace la raccolta differenziata
- Idonee per uso interno ed esterno
- Altri colori e soggetti personalizzabili su richiesta

### Recycling stickers

- Pre-cut adhesive labels made from gloss PVC
- Can be applied on all types of surfaces, both plastic and metal
- Useful to encourage waste sorting
- Suitable for indoor and outdoor use
- Extra texts, icons and colours can be customised on request

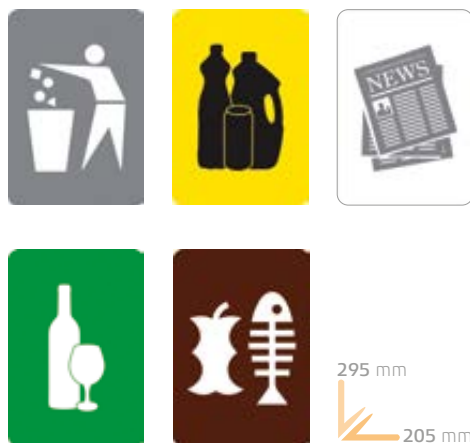

295 mm  
205 mm

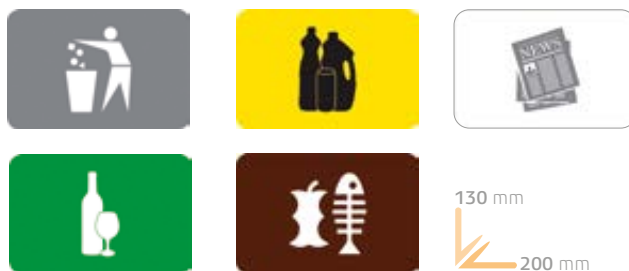

130 mm  
200 mm



	Generico General Waste	Plastica Plastic	Carta Paper	Vetro Glass	Umido Food waste
Etichetta autoadesiva orizzontale 200x130 mm Recycling stickers horizontal 200x230 mm	701070	701071	701072	701073	701074
Etichetta autoadesiva verticale 205x295 mm Recycling stickers vertical 205x295 mm	701050	701051	701052	701053	701054

## STIK

### Etichette autoadesive

- Etichette adesive pre-fustellate in vinile bianco o nero opaco
- Applicabili su tutti i tipi di superfici, sia plastica che metallo
- Utili per organizzare in modo efficace la raccolta differenziata
- Idonee per uso interno ed esterno
- Altri testi, soggetti e colori personalizzabili su richiesta

### Recycling stickers

- Pre-cut adhesive labels made from matt white or black vinyl
- Can be applied on all types of surfaces, both plastic and metal
- Useful to encourage waste sorting
- Suitable for indoor and outdoor use
- Extra texts, icons and colours can be customised on request



SCANSIONA IL QR CODE E GUARDA  
IL VIDEO TUTORIAL

SCAN THIS QR CODE TO SEE THE VI-  
DEO TUTORIAL







# STIK

ITA Vinile Nero o Bianco / White or black vinyl

**GENERICO**  
**PLASTICA**  
**CARTA**  
**VETRO**  
**ORGANICO**  
**RICICLABILE** NEW  
**NON RICICLABILE** NEW

ENG Vinile Nero o Bianco / White or black vinyl

**GENERAL WASTE**  
**PLASTIC**  
**PAPER**  
**GLASS**  
**FOOD WASTE**  
**RECYCLABLE** NEW  
**NON-RECYCLABLE** NEW

Icone / Icons



FRA Vinile Nero o Bianco / White or black vinyl

**AUTRES DECHETS**  
**PLASTIQUE**  
**PAPIER**  
**VERRE**  
**COMPOSTABLE**  
**RECYCLABLE** NEW  
**NON RECYCLABLE** NEW

DEU Vinile Nero o Bianco / White or black vinyl

**RESTMULL**  
**PLASTIK**  
**PAPIER**  
**GLAS**  
**BIOMÜLL**  
**RECYCELBAR** NEW  
**NICHT RECYCELBAR** NEW

Altezza lettera: 45 mm.  
La lunghezza cambia a seconda della parola.

Letter height: 45 mm.  
The length changes according to the word.

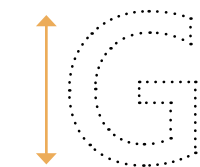

45 mm

Misure riquadro icone  
Icons frame sizes

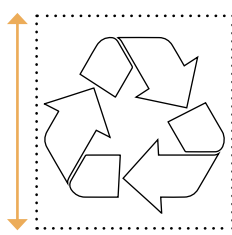

130 mm

120 mm

	ICON	ITA	ENG	FRA	DE
Generico (Nera) General waste (Black)	711210	711300	711310	711320	711330
Plastica (Nera) Plastic (Black)	711211	711301	711311	711321	711331
Carta (Nera) Paper (Black)	711212	711302	711312	711322	711332
Vetro (Nera) Glass (Black)	711213	711303	711313	711323	711333
Organico (Nera) Food waste (Black)	711214	711304	711314	711324	711334
Riciclabile (Nera) Recyclable (Black) <small>NEW</small>	711216	711306	711316	711326	711336
Non riciclabile (Nera) Non-recyclable (Black) <small>NEW</small>	711217	711307	711317	711327	711337

	ICON	ITA	ENG	FRA	DE
Generico (Bianca) General waste (White)	711200	711100	711110	711120	711130
Plastica (Bianca) Plastic (White)	711201	711101	711111	711121	711131
Carta (Bianca) Paper (White)	711202	711102	711112	711122	711132
Vetro (Bianca) Glass (White)	711203	711103	711113	711123	711133
Organico (Bianca) Food waste (White)	711204	711104	711114	711124	711134
Riciclabile (Bianca) Recyclable (White) <small>NEW</small>	711206	711106	711116	711126	711136
Non riciclabile (Bianca) Non-recyclable (White) <small>NEW</small>	711207	711107	711117	711127	711137



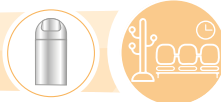

## APOLLO

52  
L

110  
L

Secchio interno  
Inner bucket



880 mm  
415 mm

690 mm  
310 mm

### Gettacarte push a pedale

- Acciaio inox brillante
- Sportello inox con apertura a pedale
- Maniglie laterali per un facile spostamento
- Secchio interno galvanizzato con maniglia
- Base in plastica ABS

### Pedal push waste bin

- Polished stainless steel
- Pedal-operated Stainless steel lid
- Easy-grip side handles for easy handling
- Removable galvanized steel inner liner with handle
- Non-skid ABS base

Gettacarte a pedale inox brillante 52 L  
Polished stainless steel pedal bin 52 L

106021

## APOLLINO NEW

40  
L

50  
L

Secchio interno  
Inner bucket



790 mm  
360 mm

505 mm  
323 mm

### Gettacarte push a pedale

- Acciaio inox 201 satinato "anti-traccia"
- Sportello con apertura a pedale senza contatto manuale
- Testa retraibile per accedere al secchio
- Secchio interno in acciaio zincato
- Base in plastica

### Pedal push waste bin

- 201 Brushed s.steel "finger print"
- Pedal-operated door with no hand contact
- Retractable head for access to the bucket
- Galvanised steel inner bin
- Plastic base



Apertura e secchio interno  
Opening and internal bucket

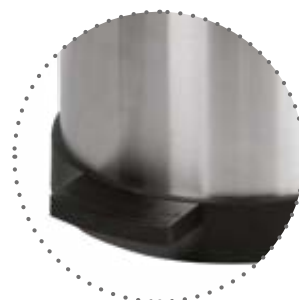

Pedale in plastica  
Plastic pedal

Gettacarte acciaio inox 201 satinato "anti-traccia" 40 L  
"Finger print" brushed 201 s. steel pedal bin 40 L

112001

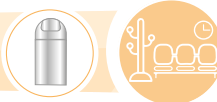

## APOLLO



Varianti colore / Colors available



### Gettacarte push

- Acciaio inox, con finitura brillante o satinata
- Metallo verniciato con polvere epossidica
- Sportello inox con apertura push
- Maniglie laterali per un facile spostamento
- Secchio interno galvanizzato con maniglia
- Base in plastica ABS

### Push waste bin

- Polished or brushed stainless steel body
- Powder epoxy coated steel body
- Push flap opening from stainless steel
- Easy-grip side handles for easy handling
- Removable galvanized steel inner bucket with handle
- Non-skid ABS base

Gettacarte push inox brillante 52 L Polished stainless steel push bin 52 L	106031
Gettacarte push inox satinato 52 L Brushed stainless steel push bin 52 L	106032
Gettacarte push nero 52 L Black coated steel push bin 52 L	106033

## APOLLINO



Varianti colore / Colors available



### Gettacarte push

- Acciaio inox satinato o metallo verniciato
- Sportello inox con apertura push
- Testa asportabile per accedere al secchio
- Secchio interno galvanizzato con maniglia
- Base in gomma

### Push waste bin

- Brushed s.steel or powder epoxy coated steel
- Stainless steel door with push opening
- Removable lid with push flap opening
- Removable galvanized steel inner bucket with handle
- Non-skid ABS base

Gettacarte push inox satinato 40 L Brushed s.steel push waste bin 40 L	106051
Gettacarte nero con testa push inox 40 L Black waste bin with s.steel push lid 40 L	106053

## STORICO



### Gettacarte push

- Acciaio inox brillante o metallo verniciato
- Apertura con sportello a spinta a ritorno automatico
- Sportello push in inox
- Possibilità di fissaggio murale

### Push waste bins

- Polished s.steel or coated steel
- Push opening trap
- Stainless steel opening
- Suitable for wall mounting



Gettacarte con corpo nero 50 L Waste bin with black bucket 50 L	790057
Gettacarte con corpo nero e posacenere 50 L Waste bin with black bucket and ashtray 50 L	790457
Gettacarte con corpo inox 50 L Waste bin with s.steel bucket 50 L	790557



## STORICO

50  
L



940 mm  
240 mm  
325 mm

### Gettacarte basculante

- Acciaio inox brillante o metallo verniciato
- Apertura con sportello basculante
- Sportello basculante in inox
- D'appoggio

### Swing waste bins

- Polished s.steel or coated steel
- Swinging opening
- Stainless steel swinging opening
- Floorstanding



Gettacarte con corpo nero 50 L Waste bin with black bucket 50 L	790063
Gettacarte con corpo inox 50 L Waste bin with s.steel bucket 50 L	790563

## SWINGO

50  
L



Cilindrico  
Cylindrical



720 mm  
410 mm

60  
L



Ovale  
Oval



720 mm  
390 mm  
495 mm

### Gettacarte con coperchio basculante

- Struttura in acciaio inox, con finitura brillante
- Coperchio basculante in ABS
- Secchio interno in polipropilene con maniglia

### Swing waste bin

- Stainless steel body, with polished finish
- ABS lid with stabilizing counter balance
- Polypropylene inner bucket with handle

Gettacarte cilindrico cop. basculante inox 50 L Cylindrical swing waste bin s.steel 50 L	109777
Gettacarte ovale cop. basculante inox 60 L Oval swing waste bin s.steel 60 L	109796

## BASCULINO

52  
L



720 mm  
380 mm



Apertura / Opening

### Gettacarte con coperchio basculante

- Acciaio inox brillante
- Coperchio in inox basculante per un facile utilizzo
- Secchio interno galvanizzato con maniglia
- Base in gomma

### Swing waste bin

- Polished stainless steel
- Swing lid in polished stainless steel
- Galvanized inner bucket with handle
- Non-skid rubber base



Gettacarte coperchio basculante inox brillante 52 L Swing waste bin polished stainless steel 52 L	606091
--	--------



## GRISÙ KRIL

80  
L

140 mm

110  
L

200 mm



675 mm

450 mm

685 mm

510 mm

### Gettacarte trasparente auto-estinguente

- Coperchio e base in metallo verniciato con polvere epossidica
- Corpo in polimetilmetacrilato trasparente
- Testa soffocante per bloccare la propagazione del fuoco
- **Sistema anti-terrorismo, rapido controllo del contenuto**
- Base in gomma

### Transparent auto-extinguishing waste bin

- Lid and base from coated steel
- Transparent tube from PMMA
- Special fire-extinguishing lid prevents fire from spreading
- **Functional design makes it easy to view the contents**
- Non-skid rubber base

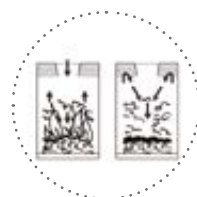

Principio di autoestinzione  
Flame-extinguishing process



Auto-estinguente  
Self extinguishing

Gettacarte trasparente antifuoco 80 L  
Transparent fireproof waste bin 80 L

774021

Gettacarte trasparente antifuoco 110 L  
Transparent fireproof waste bin 110 L

774041

## STORICO KRIL

50  
L



930 mm

240 mm  
330 mm

### Gettacarte trasparente

- Struttura in metallo verniciato con polvere epossidica
- Frontale e laterali in policarbonato trasparente
- **Sistema anti-terrorismo, rapido controllo del contenuto**
- Sportello in inox a spinta con ritorno automatico
- D'appoggio o murale (viteria non inclusa)

### Transparent waste bins

- Powder epoxy coated steel frame
- Front and lateral sides from transparent polycarbonate
- **Functional design makes it easy to view the contents**
- Push opening in polished s.steel
- Freestanding or wall mounted (screws not included)



Gettacarte trasparente 50 L  
Transparent waste bin 50 L

774057





## MILUNA

### Gettacarte murale

- Versione in acciaio inox con finitura satinata
- Versione in metallo verniciato con polvere epossidica
- Elastico fermasacco
- Fissaggio a muro in 2 punti
- Viteria non inclusa

### Wall mounted waste bin

- Stainless steel with brushed finish
- Powder epoxy coated steel
- Bag held in place by elastic band
- Wall mounted fastening
- Fixing hardware not included



DISPONIBILE IN AR SU MEDIAL APP  
AVAILABLE IN AR ON MEDIAL APP



20  
L



388 mm  
195 mm  
395 mm



40  
L



647 mm  
195 mm  
395 mm



	Nero Black	Bianco White	Inox satinato Brushed s.steel
Gettacarte murale 20 L Wall mounted waste bin 20 L	<a href="#">773031</a>	<a href="#">773033</a>	<a href="#">773036</a>
Gettacarte murale 40 L Wall mounted waste bin 40 L	<a href="#">773041</a>	<a href="#">773043</a>	<a href="#">773046</a>



## FLIP



Coperchio basculante  
Swinging lid

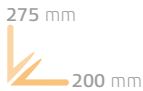

### Cestino basculante

- Acciaio inox AISI 304 brillante
- Coperchio basculante
- Ghiera fermasacco
- Ideale per camera d'albergo

### Swing paper bin

- AISI 304 polished s.steel
- Swinging lid
- Upper ring to hide the bag
- Ideal for hotel rooms

Cestino basculante inox AISI 304 brillante 7 L  
Polished AISI 304 s.steel paper bin 7 L

906607

## BOBBINO

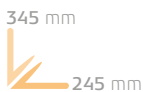

### Cestino

- Struttura in acciaio inox brillante
- Ghiera fermasacco
- Secchio interno in plastica con maniglia
- Base in plastica

### Paper bin

- Body from polished stainless steel
- Upper ring to hide the bag
- Plastic inner bucket with handle
- Rubberized base

Cestino inox brillante 8 L  
Polished s.steel paper bin 8 L

906701

## GETSI INOX

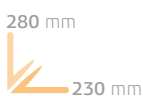

### Cestino

- Acciaio inox
- Estetica ricercata
- Pratico ed elegante

### Paper bin

- Stainless steel body
- Several finishes available
- Sleek and elegant design
- Easy to clean

Varianti colore / Colors available



Cestino inox satinato 11 L  
Paper bin brushed s.steel 11 L

103034

Cestino inox brillante 11 L  
Paper bin polished s.steel 11 L

103035

Cestino inox brillante perforato 11 L  
Paper bin perforated polished s.steel 11 L

103036



## SLAIS

### Cestino per la raccolta differenziata

- Struttura in metallo verniciato nero
- Ghiera rimovibile per nascondere e facilitare il ricambio del sacco
- Indicato per camere d'albergo, cabine delle navi e uffici
- **Versione 2 FLUSSI:**  
due secchi colorati ed estraibili in polipropilene (6 L + 6 L)
- **Versione 3 FLUSSI:**  
tre secchi colorati ed estraibili in polipropilene (6 L + 2 x 3 L)  
in opzione, coperchio divisorio con sportelli impressi (PAPER, FOOD, PLASTIC)

### Recycling paper bin

- Black coated steel
- Removable top to hide the waste bag and to facilitate bag change
- Suitable in hotel rooms, ship cabins as well as office workstation
- **2 STREAMS version:**  
two removable colored polypropylene inner buckets (6 L + 6 L)
- **3 STREAMS version:**  
three removable colored polypropylene inner buckets (6 L + 2 x 3 L)  
as option, lid with flaps marked PAPER, FOOD, PLASTIC



DISPONIBILE IN AR SU MEDIAL APP  
AVAILABLE IN AR ON MEDIAL APP



### 2 Flussi / 2 Streams

12  
L



Secchi interni (6 L + 6 L)  
Inner buckets (6 L + 6 L)

315 mm  
244 mm

Cestino raccolta differenziata 12 L (6 + 6 L)  
Recycling paper bin 12 L (6+ 6 L)

770146

### 3 Flussi / 3 Streams

12  
L



Secchi interni (6 L + 2 x 3 L)  
Inner buckets (6 L + 2 x 3 L)



Coperchio divisorio  
(venduto separatamente)

Lid with flaps  
(sold separately)

315 mm  
244 mm

Cestino raccolta differenziata 12 L (6 + 2x3 L)  
Recycling paper bin 12 L (6+ 2x3 L)

770141

Coperchio divisorio con sportelli impressi  
Separator lid with marked flaps

770191



## POIS

14  
L



300 mm  
240 mm

### Cestino perforato

- Metallo verniciato con polvere epossidica
- Design traforato

### Perforated paper bin

- Powder epoxy coated steel
- Compact and sleek design

Cestino nero 14 L  
Paper bin black steel 14 L

770111

## DOT

13  
L



280 mm  
265 mm  
220 mm

### Cestino perforato

- Metallo verniciato con polvere epossidica
- Design traforato

### Perforated paper bin

- Powder epoxy coated steel
- Compact and sleek design

Cestino perforato (Imballo singolo)  
Perforated paper bin (sold singly)

150131

Cestino perforato (20 pz per cartone)  
Perforated paper bin (20 pcs per pack)

150531

## PALACE

13  
L

Cilindrico  
Cylindrical



310 mm  
230 mm

13  
L

Ovale  
Oval



310 mm  
180 mm  
250 mm

### Cestino

- Metallo rivestito in finta pelle nera
- Anello fermasacco in acciaio inox
- Base in ABS
- Disponibile nella versione ovale e cilindrica

### Paper bin

- Metal body covered by black faux leather
- Removable stainless steel rim to hide plastic bag
- Non-scratch rubber base
- Available in oval or cylindrical geometry

Cestino simil-pelle cilindrico 13 L  
Cylindrical paper bin faux leather 13 L

103050

Cestino simil-pelle ovale 13 L  
Oval paper bin faux leather 13 L

103051

## GETSI CLASSIC

12  
L



305 mm  
225 mm

Varianti colore  
Colors available



### Cestino

- Metallo verniciato con polvere epossidica
- Base in plastica
- Facile da svuotare e pulire
- Ideale sotto la scrivania

### Paper bin

- Powder epoxy coated steel body
- Non-scratch rubber base
- Easy to empty and clean
- Stylish under a desk

Cestino bianco 12 L  
Paper bin white 12 L

103030

Cestino nero 12 L  
Paper bin black 12 L

103031

Cestino marrone 12 L  
Paper bin brown 12 L

103032



## GRISÙ PLASTIC

14  
L



310 mm  
210 mm  
295 mm

### Cestino in plastica ignifuga

- Polipropilene ignifugo (Classe V0 rispetto alla norma UL 94)
- Disponibile in vari colori e forme
- Ideale per camere d'albergo e uffici
- Certificato CNPP

### Fire-retardant plastic paper bin

- Fire-retardant polypropylene (Class V0 relative to the UL 94 norm)
- Available in several colors and designs
- Ideal for hotel rooms and offices
- CNPP certified



Varianti colore / Colors available



Cestino ignifugo cilindrico beige 8 L Fire-retardant paper bin cylindrical beige 8 L	114010
Cestino ignifugo cilindrico nero 8 L Fire-retardant paper bin cylindrical black 8 L	114011
Cestino ignifugo rettangolare nero 14 L Fire-retardant paper bin rectangular black 14 L	114021
Cestino ignifugo rettangolare grigio 14 L Fire-retardant paper bin rectangular grey 14 L	114022

8  
L



295 mm  
210 mm



Ignifugo  
Fire retardant

## BASKET

12  
L



300 mm  
280 mm



### Cestino

- Polipropilene nero, 100% riciclato
- Pratico e di facile pulizia

### Paper bin

- 100% Recycled polypropylene
- Easy to use and clean

## BASKET

12  
L



285 mm  
290 mm

Varianti colore  
Colors available



### Cestino

- Cestino in polipropilene
- Pratico e di facile pulizia

### Paper bin

- Polypropylene plastic body
- Easy to use and clean

## BASKET

9  
L

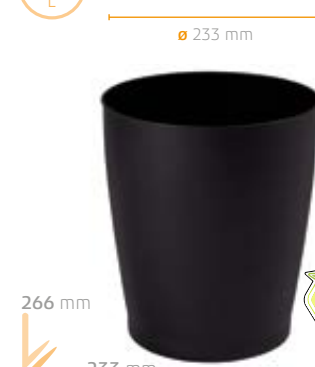

266 mm  
233 mm



### Cestino

- Polipropilene nero, 100% riciclato
- Pratico e di facile pulizia

### Paper bin

- 100% Recycled polypropylene
- Easy to use and clean

ATTENZIONE: alcuni prodotti in plastica riciclata possono subire leggere variazioni di tonalità cromatica  
WARNING: some recycled plastic products may have slight variations in colour shade

Cestino nero (imballo singolo) Black paper bin (sold singly)	907121
Cestino nero (20 pz/cartone) Black paper bin (20 pcs/pack)	907321

Cestino bianco traforato 12 L Paper bin perforated white 12 L	906400
Cestino nero traforato 12 L Paper bin perforated black 12 L	906401
Cestino grigio traforato 12 L Paper bin perforated grey 12 L	906402

ATTENZIONE: alcuni prodotti in plastica riciclata possono subire leggere variazioni di tonalità cromatica  
WARNING: some recycled plastic products may have slight variations in colour shade

Cestino nero (imballo singolo) Black paper bin (sold singly)	907091
Cestino nero (24 pz/cartone) Black paper bin (24 pcs/pack)	907291





## BIG

### Posacenere-gettacarte

- Inox brillante con secchio interno in metallo galvanizzato con maniglia
- Posacenere e griglia in metallo nero
- Base in plastica
- Sabbia in opzione (cod. 799640)
- Possibile utilizzo in aree esterne coperte

### Ashbin

- Polished stainless steel body with galvanized steel inner bucket
- Steel ashtray with black coated steel grid
- Plastic bottom ring prevents damage to the floor
- Sand bag on request (ref. 799640)
- Suitable for use in covered outdoor areas

50  
L

60  
L

400

755 mm  
435 mm



Opzione sabbia  
Sand in option

Posacenere-gettacarte inox brillante 50 L  
Ashbin polished s.steel 50 L

790610

## GRISÙ

### Posacenere-gettacarte auto-estinguente

- Metallo verniciato con polveri epossidiche
- Posacenere con griglia (sacco sabbia da 1 kg incluso)
- Gettacarte con coperchio autoestinguente
- Base in gomma
- Possibile utilizzo in aree esterne coperte

### Auto-extinguishing ashbin

- Powder epoxy coated steel
- Ashtray with grid (1kg sand included)
- Auto-extinguisher lid
- Plastic bottom ring prevents damage to the floor
- Suitable for use in covered outdoor areas



30  
L

100

815 mm  
260 mm



50  
L

250

810 mm  
340 mm



90  
L

300

970 mm  
405 mm



Posacenere-gettacarte nero  
Ashbin black coated steel

30 L	50 L	90 L
775031	775051	775091
775032	775052	775092



## DOS

19  
L

30  
L

100



730 mm

265 mm

### Posacenerere-gettacarte

- Inox brillante e metallo verniciato
- Testa antifuoco con bacinella posacenerere
- Secchio in acciaio galvanizzato in opzione
- Base in polipropilene

### Ashbin

- Stainless steel or epoxy coated steel body
- Self-extinguishing lid with ashtray on top
- Galvanized steel inner bucket on request
- Plastic bottom ring prevents damage to the floor



Varianti colore / Colors available



Posacenerere-gettacarte inox brillante 19 L  
Ashbin polished s.steel 19 L

775020

Posacenerere-gettacarte nero 19 L  
Ashbin black coated steel 19 L

775021

Secchio in opzione  
Bucket in option

775029

## QUADRO 27

27  
L

30  
L

100



710 mm

200 mm  
300 mm

### Posacenerere-gettacarte

- Metallo verniciato con polvere epossidica
- Posacenerere rimovibile in acciaio inox
- Bacinella interna del posacenerere in acciaio galvanizzato
- Secchio interno in opzione

### Ashbin

- Powder epoxy coated steel
- Removable top made from stainless steel
- Ash container made from galvanized steel
- Inner bucket on request



Posacenerere-gettacarte nero 27 L  
Ashbin black coated steel 27 L

790018

Secchio interno in opzione  
Inner bucket as option

790001



## MINI

11  
L



600 mm  
200 mm

### Posacenero-gettacarte

- Acciaio inox brillante
- Metallo verniciato con polvere epossidica
- Posacenero con griglia in inox
- Privo di secchio interno

### Ashbin

- Polished stainless steel
- Powder epoxy coated steel
- Ashtray with steel grid
- Comes without inner bucket



Varianti colore / Colors available



Posacenero-gettacarte inox brillante 11 L  
Ashbin polished s. steel 11 L

790613

Posacenero-gettacarte nero 11 L  
Ashbin black coated steel 11 L

790113

## CÉNERE

22  
L



650 mm  
260 mm  
250 mm

### Posacenero-gettacarte

- Acciaio inox brillante o metallo verniciato con polvere epossidica
- Secchio interno galvanizzato da 22 L
- Testa antifuoco
- Guarnizione a protezione dei bordi dell'apertura del gettacarte
- Base in plastica antigraffio

### Ashbin

- Polished stainless steel or powder epoxy coated steel
- Galvanized steel inner bucket 22 L
- Auto-extinguishing lid
- Wide opening with rubber edges
- Plastic bottom ring prevents damage to the floor



Varianti colore / Colors available



Posacenero-gettacarte inox brillante 22 L  
Ashbin polished s. steel 22 L

106011

Posacenero-gettacarte nero 22 L  
Ashbin black coated steel 22 L

106012

Posacenero  
Ashbin



## CÉNERE PLAST

25  
L

30  
L

100



700 mm  
250 mm

### Posaceneri-gettacarte

- Polipropilene
- Piatto ignifugo

### Ashbin

- Polypropylene body
- Fireproof plate



Posaceneri-gettacarte polipropilene nero 25 L  
Black polypropylene ashbin 25 L

710009

## SAND



20 mm  
210 mm  
200 mm

### Sacco di sabbia

- Sabbia fine per posaceneri (1 Kg)
- Assicura uno rapido spegnimento della sigaretta senza cattivi odori
- Se ne consiglia la sostituzione una volta alla settimana

### Bag of sand

- High-quality sand for ashtrays (1 Kg)
- Ensures quick fire extinguishing and stops smell from spreading
- We recommend to change the sand once a week



Sacco di sabbia bianca 1 Kg  
Bag of white sand 1 Kg

799640

## NIDO

0,5  
L

260

130 mm  
93 mm  
110 mm



2  
L

1000

170 mm  
155 mm  
170 mm



Varianti colore / Colors available



### Posaceneri murale

- Acciaio inox satinato o metallo verniciato con polvere epossidica
- Testa antifuoco
- Svuotamento facilitato tramite ribaltamento del posaceneri
- Fissaggio murale (viteria inclusa)

### Wall mounted ashtray

- Brushed stainless steel or powder epoxy coated steel body
- Auto-extinguishing lid
- Easy to empty by tipping the ashtray up
- Wall mounted (screws included)



Posaceneri murale inox satinato 0,5 L Wall mounted ashtray brushed s.steel 0,5 L	106001
Posaceneri murale silver punteggiato 0,5 L Wall mounted ashtray dotted silver steel 0,5 L	106002
Posaceneri murale inox satinato 2 L Wall mounted ashtray brushed s.steel 2 L	106003
Posaceneri murale silver punteggiato 2 L Wall mounted ashtray dotted silver steel 2 L	106004



## PLUVIAL

27  
L



600 mm  
255 mm

### Portaombrelli

- Inox brillante o metallo verniciato con polvere epossidica
- Vaschetta in plastica per la raccolta dell'acqua
- Base in polipropilene
- Può essere usato come gettacarte

### Umbrella stand

- Polished stainless steel or coated steel body
- Plastic base to protect floor surface
- Removable inner plastic tray for water collection
- Dual purpose (umbrella stand or paper bin)



Varianti colore / Colors available

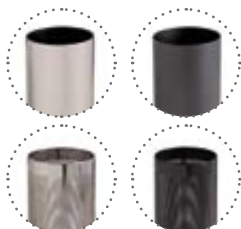

	Inox S. steel	Nero Black
Portaombrelli 27 L Umbrella stand 27 L	775100	775101
Portaombrelli perforato 27 L Perforated umbrella stand 27 L	775110	775111

## PLUVIO BASIC

22  
L



500 mm  
240 mm

Varianti colore  
Colors available



### Portaombrelli

- Acciaio inox brillante o metallo verniciato con polvere epossidica
- Può essere usato come gettacarte
- Vaschetta in plastica per la raccolta dell'acqua

### Umbrella stand

- Polished stainless steel or powder epoxy coated steel body
- Dual purpose (umbrella stand or paper bin)
- Removable inner plastic tray for water collection



Portaombrelli inox brillante 22 L  
Umbrella stand polished s. steel 22 L

775120

Portaombrelli nero 22 L  
Umbrella stand black coated steel 22 L

775121

## PLUVIO PLASTIC

25  
L



520 mm  
250 mm

### Portaombrelli

- Struttura in polipropilene
- Economico e robusto
- Può essere usato come gettacarte

### Umbrella stand

- Polypropylene body
- Heavy-duty and robust
- Dual purpose (umbrella stand or paper bin)



Portaombrelli polipropilene nero 25 L  
Umbrella stand black polypropylene 25 L

710008





## MULTI



525 mm  
260 mm  
520 mm

### Portaombrelli

- Struttura in metallo verniciato con polvere epossidica
- Bacinella di recupero dell'acqua asportabile
- Griglia inferiore ferma puntale

### Umbrella stand

- Powder-coated steel structure
- Plastic inner water tray
- Ideal for waiting rooms, shop entrance, offices, etc.



520 mm  
260 mm  
1002 mm

Portaombrelli nero 8 posti  
*Umbrella stand black steel 8 holes*

714019

Portaombrelli nero 16 posti  
*Umbrella stand black steel 16 places*

714029

## DISTRIBUTORE AUTOMATICO DI BUSTE COPRI-OMBRELLI | UMBRELLA WRAPPER



## FURBY



Buste salvagoccia  
*Wrapping bags*



740 mm  
310 mm  
205 mm

### Distributore automatico di buste copri-ombrello

- Struttura in metallo verniciato grigio
- Funzionamento meccanico senza alimentazione elettrica
- Maniglie laterali per un facile spostamento
- Ideale per evitare il gocciolamento degli ombrelli
- Design compatto ed elegante
- Capacità: fino a 500 buste copri-ombrello

### Automatic umbrella wrapper

- Coated steel body in gray finish
- Battery-free mechanical operation, no electricity or other connection required
- Built-in carry handles
- Ideal solution to prevent floor from getting wet and slippery
- Compact and elegant design
- Capacity: 500 wrapping bags max

Distributore copri-ombrello  
*Wet umbrella wrapper*

110570

Buste copri-ombrello  
*Wrapping bags*

110571



## PANCA

### Panca 2 posti + tavolo

- Struttura portante in acciaio elettrosaldato
- Seduta e tavolo (PANCA DUE) in acciaio microforato
- A norma UNI EN 1728/00
- Ideale per sale d'attesa, aeroporti, stazioni...

### Two-seat bench + table

- Light grey powder epoxy coated steel structure
- Seats and table (PANCA DUE) in light grey powder epoxy coated perforated steel
- Bench can be fixed to the floor
- Ideal for waiting rooms: airports, train stations, museums, hospitals



POSSIBILITÀ DI PERSONALIZZARE LA CONFIGURAZIONE  
POSSIBILITY TO CUSTOMIZE PRODUCT CONFIGURATION

## PANCA DUE



830 mm  
450 mm 620 mm  
1650 mm

## PANCA TRE



830 mm  
450 mm 620 mm  
1650 mm

Panca 2 posti + tavolo 2-seat bench + table	703051
Panca 3 posti 3-seat bench	703050

SU RICHIESTA | ON DEMAND

Articoli solo su richiesta. Produzioni speciali. Tempistiche da valutare.  
Items only on request. Special productions. Timing to be evaluated.

NEW



Panca 2 posti 2-seat bench	703052
Panca 4 posti 4-seat bench	703054
Panca 5 posti 5-seat bench	703055

## GAMMA

### Colonne per cordone

- Acciaio inox brillante o inox dorato
- Diametro del tubo: 50 mm
- Testa sagomata con 4 punti di fissaggio ganci
- Possibilità di applicare un pannello informativo
- Base zavorrata

### Posts with ropes

- Stainless steel or golden s.steel
- Tube diameter: 50 mm
- Top with 4 openings for rope clip ends
- Compatible with information board
- Base includes a stabilizing mass



4 punti di aggancio  
4 anchor points



Possibile personalizzazione  
Customizable top

Colonna inox brillante Polished s.steel post	103300
Colonna inox dorata Golden s.steel post	103301
Colonna inox AISI 304 brillante AISI 304 polished s.steel post	103800



## GAMMA



### Cordone con 2 ganci

- Cordone in corda intrecciata
- Lunghezza 1,5 m
- Diametro del cordone: 30 mm
- Anelli di fissaggio inox o dorati

### Rope with 2 hooks

- Ropes for traditional posts
- 1,5 m long
- Rope diameter: 30 mm
- Golden or s.steel fixing hooks

Cordone blu - ganci inox Blue rope with s.steel ring hooks	106320
Cordone blu - ganci dorati Blue rope with golden ring hooks	106330
Cordone bordeaux - ganci inox Bordeaux rope with s.steel ring hooks	106321
Cordone bordeaux - ganci dorati Bordeaux rope with golden ring hooks	106331
Cordone nero - ganci inox Black rope with s.steel ring hooks	106322
Cordone nero - ganci dorati Black rope with golden ring hooks	106332
Cordone grigio - ganci inox Grey rope with s.steel ring hooks	106323
Cordone grigio - ganci dorati Grey rope with golden ring hooks	106333

## GAMMA



Ø 30 mm

Varianti colore  
Colors available



### Cordone su misura

- Cordone in corda intrecciata
- Venduto a metro lineare
- Diametro del cordone: 30 mm
- Anelli di fissaggio inox o dorati

### Custom-cut rope

- Rope for traditional posts
- Custom-cut length of rope
- Rope diameter: 30 mm
- Golden or s.steel fixing hooks

Ganci / Hooks



Inox / S.steel Dorati / Golden

Cordone blu Blue rope	106340
Cordone bordeaux Bordeaux rope	106341
Cordone nero Black rope	106342
Cordone grigio Grey rope	106343
Ganci dorati Golden ring hooks	106994
Ganci inox S.steel ring hooks	106995

## GAMMA



36 mm  
35 mm  
48 mm

Varianti colore  
Colors available



### Anello per fissaggio murale

- Inox brillante o dorato

### Wall mounted ring for ropes

- Polished stainless steel or golden stainless steel

Gancio inox brillante Polished stainless steel hook	103310
Gancio inox dorato Golden stainless steel hook	103311

## GAMMA BOARD

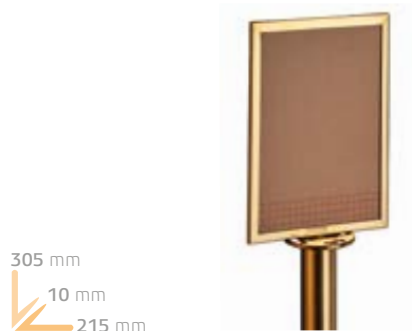

305 mm  
10 mm  
215 mm

Varianti colore  
Colors available



### Pannello informativo

- Formato A4 in posizione verticale
- Cornice inox o dorata
- Non richiede adattatori
- Svitare il pomello superiore ed avvitare il pannello

### Information board

- Vertical board (A4 dimensions)
- Stainless steel frame, polished or golden finish
- No need of adaptor
- Unscrew the top and fasten the board

Pannello informativo con cornice inox brillante Info board with polished s.steel frame	103380
Pannello informativo con cornice inox dorato Info board golden plated s.steel frame	103383

## ALFA

### Colonne con nastro

- Acciaio inox o metallo verniciato
- Diametro del palo: 63 mm
- Lunghezza nastro: 2 mt

### Retractable belt stanchions

- Polished s. steel or coated steel
- Stanchion diameter: 63 mm
- Belt length: 2 mt



Possibile personalizzazione del nastro  
Custom print belt on request

Colonna Station	Nastro Belt	
Inox S. steel	Blu Blue	103350
Inox S. steel	Rosso Red	103351
Inox S. steel	Nero Black	103352
Nero Black	Blu Blue	103340
Nero Black	Rosso Red	103341
Nero Black	Nero Black	103342





## ALFA BOARD



305 mm  
10 mm  
215 mm

### Pannello informativo

- Formato A4 in posizione verticale
- Cornice in inox
- Supporti per pannello compatibili solo con modello ALFA

### Information board

- Vertical board (A4 dimensions)
- Polished steel frame
- Adaptors only compatible with ALFA stanchions



Pannello formato A4 A4 information board	103380
Supporto plastico per pannello Plastic adaptor	103381
Supporto inox per pannello Stainless steel adaptor	103382

## ALFA MURAL



### Sistema murale

- Acciaio inox o metallo verniciato nero
- Sistema murale con nastro incorporato e terminale in plastica
- Lunghezza nastro: 2 m
- Ricettore murale incluso

### Wall mounted retractable belt

- Stainless steel or coated steel
- Wall mounted system with belt and plastic clip
- Installation hardware in polished s.steel or black coated s.steel
- Belt length: 2 m
- Wall receptor included



Ricettore murale  
Wall receptor

Varianti colore / Colors available



Sistema murale inox nastro blu Wall mounted s.steel system with blue belt	103390
Sistema murale inox nastro rosso Wall mounted s.steel system with red belt	103391
Sistema murale nero nastro blu Wall mounted clack steel system with blue belt	103392
Sistema murale nero nastro rosso Wall mounted clack steel system with red belt	103393
Ricettore murale Wall receptor	103987



## PITTONOIR

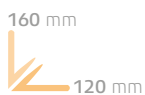

### Pittogrammi

- Alluminio nero
- Incisione con laser 3D
- Biadesivo per fissaggio
- Icone personalizzabili su richiesta

### Pictograms

- Black coated steel
- 3D laser engraving
- Can be fixed with 2 strips of double-sided tape
- Customization of symbols on request



Informazioni <i>Information</i>	719910
Uomo <i>Man</i>	719911
Donna <i>Woman</i>	719912
WC <i>WC</i>	719913
Diversamente abile <i>Wheelchair</i>	719914
Uomo & Donna <i>Man &amp; Woman</i>	719916
Vietato fumare <i>No smoking</i>	719917
Infermeria <i>Infirmery</i>	719918
Wi-Fi <i>Wi-Fi</i>	719919





## PITTO



160 mm  
120 mm

### Pittogrammi

- Alluminio satinato
- Stampa digitale
- Biadesivo per fissaggio

### Pictograms

- Brushed aluminium
- Digital printing
- Can be fixed with 2 strips of double-sided tape



Uomo <i>Man</i>	719951
Donna <i>Woman</i>	719952
WC <i>WC</i>	719953
Diversamente abile <i>Wheelchair</i>	719954

## PITTOPLAST



100 mm  
100 mm

### Pittogrammi

- PVC adesivo
- Stampa digitale

### Pictograms

- PVC stickers
- Digital printing



Uomo <i>Man</i>	701021
Donna <i>Woman</i>	701022
WC <i>WC</i>	701023
Diversamente abile <i>Wheelchair</i>	701024
Uomo & Donna <i>Man &amp; Woman</i>	701026
Vietato fumare <i>No smoking</i>	701027
Infermeria <i>Infirmery</i>	701028



## ELISA

### Appendiabiti murali

- Struttura in metallo verniciato
- Murale 2, 3, 4 o 5 appendini

### Wall mounted coat stand

- Powder epoxy coated steel
- Wall mounted coat stand (with 2, 3, 4 or 5 hooks)



Appendiabiti murale Elisa 2 ganci <i>Wall mounted coat stand Elisa 2 hooks</i>	<b>703012</b>
Appendiabiti murale Elisa 3 ganci <i>Wall mounted coat stand Elisa 3 hooks</i>	<b>703013</b>
Appendiabiti murale Elisa 4 ganci <i>Wall mounted coat stand Elisa 4 hooks</i>	<b>703014</b>
Appendiabiti murale Elisa 5 ganci <i>Wall mounted coat stand Elisa 5 hooks</i>	<b>703015</b>

## COSTANCE



### Appendiabiti

- Struttura in metallo cromato
- Base in metallo verniciato nero
- 8 appendini in polipropilene
- Base con piedini in gomma

### Coat stand

- Structure and base in coated steel
- Rotating top
- 8 polypropylene hooks
- Metal base with rubber tips



Appendiabito Costance  
*Coat stand Costance*

**703001**



## CHIARA



### Appendiabiti

- Struttura in metallo verniciato
- Base in polipropilene
- 8 appendini in polipropilene
- Portaombrelli con vaschetta

### Coat stand

- Structure in coated steel
- Polypropylene base
- 8 polypropylene hooks
- Umbrella holder with drip tray



1660 mm  
450 mm

Appendiabito Chiara  
Coat stand Chiara

703004

## GIORGIA



### Appendiabiti

- Struttura in metallo verniciato
- Base in polipropilene
- 8 appendini in polipropilene
- Portaombrelli con vaschetta

### Coat stand

- Structure in coated steel
- Polypropylene base
- 8 polypropylene hooks
- Umbrella holder with trip tray



1700 mm  
400 mm

Appendiabito Giorgia  
Coat stand Giorgia

703002

## SOFIA



### Appendiabiti

- Struttura in metallo verniciato
- Base in polipropilene
- 8 appendini in polipropilene
- Portaombrelli con vaschetta

### Coat stand

- Structure in coated steel
- Polypropylene base
- 8 polypropylene hooks
- Umbrella holder with trip tray



1750 mm  
390 mm

Appendiabito Sofia  
Coat stand Sofia

703003





## ATTREZZATURE PER SPAZI ESTERNI EQUIPMENT FOR OUTDOOR AREAS

p.  
**220**



POSTAZIONI RACCOLTA  
DIFFERENZIATA  
*RECYCLING STATIONS*

p.  
**235**



DISPENSER SACCHETTI  
DEIEZIONI CANINE  
*DOG WASTE BAGS  
DISPENSERS*

p.  
**225**



POSACENERE-GETTACARTE  
*ASHBINS*

p.  
**236**



REGGISACCHI  
*SACK HOLDERS*

p.  
**227**

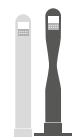

POSACENERE  
*ASHTRAYS*

p.  
**240**



CONTENITORI MOBILI  
PER ESTERNO  
*OUTSIDE MOBILE BINS*

p.  
**230**

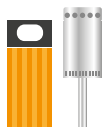

GETTACARTE  
*LITTER BINS*







## VERONA

### Gettacarte per la raccolta differenziata

- Struttura in lamiera zincata
- Verniciatura con polvere poliestere (RAL 7021)
- 3 o 4 aperture frontali di conferimento, con fasce adesive colorate
- Ospita 3 supporti ferma-sacco in filo d'acciaio (3x40 L) - **VERONA**
- Ospita 4 supporti ferma-sacco in filo d'acciaio (4x40 L) - **VERONA PLUS**
- Anta frontale con chiusura a chiave triangolare
- Zoccolo in Tubolare 50x50 con predisposizione per fissaggio a terra
- In opzione, etichette pre-fustellate in vinile per la differenziata (p. 193)

### Recycling station

- Galvanized steel case
- Polyester powder coating (RAL 7021)
- 3 or 4 front openings, complete with colored stickers
- Holds three steel wire sack holders (3 x 40 L) - **VERONA**
- Holds four steel wire sack holders (4 x 40 L) - **VERONA PLUS**
- Front door with triangular key lock
- Tubular 50x50 plinth with provision for ground fixing
- As option, PVC pre-cut adhesive labels for waste sorting (p.193)



DISPONIBILE IN AR SU MEDIAL APP  
AVAILABLE IN AR ON MEDIAL APP



120  
L

3 Flussi / 3 Streams



1094 mm  
326 mm  
1018 mm

Misure apertura di conferimento  
Front opening size

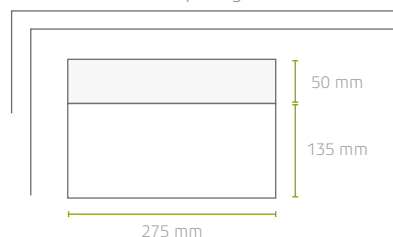

Adesivi per la raccolta differenziata acquistabili separatamente  
Waste sorting stickers sold separately



Reggisacco interno  
Inner sack holders

## VERONA PLUS

160  
L

4 Flussi / 4 Streams



1094 mm  
376 mm  
1018 mm

Misure apertura di conferimento  
Front opening size

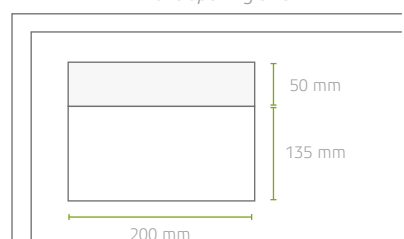

Adesivi per la raccolta differenziata acquistabili separatamente  
Waste sorting stickers sold separately



Posacenere VERONA  
VERONA Ashtray  
REF. 789390  
(p.227)



VERONA - Gettacarte per differenziata 120 L (3x40 L)  
VERONA - Recycling station 120 L (3x40 L)

789300

VERONA PLUS - Gettacarte per differenziata nero 160 L (4x40)  
VERONA PLUS - Black recycling station 160 L (4x40)

789301

VERONA - Posacenere murale in opzione  
VERONA - Mural ashtray (optional)

789390









## AMSTERDAM

### Postazione per la raccolta differenziata

- Struttura in acciaio (spessore lamiera 2 mm)
- Finitura Primer + verniciatura poliestere grigio manganese (RAL 7021)
- Due o Tre aperture di conferimento superiori
- Cornici colorate per la raccolta differenziata
- Ospita 3 o 2 supporti reggisacco in filo d'acciaio (3x40 L o 2x60 L)
- Zoccolo in Tubolare 50x50 con predisposizione per fissaggio a terra
- Serratura con chiave triangolare
- Ideale negli spazi pubblici di contesti urbani

### Recycling station

- Steel case (sheet steel thickness 2 mm)
- Primer finishing + Polyester powder coating (manganese grey RAL 7021)
- Two or three superior opening streams
- Coloured frames to encourage waste separation
- Holds 3 or 2 steel wire sack holders (3x40 L or 2x60 L)
- Tubular 50x50 plinth with provision for ground fixing
- Lock with triangular key
- Ideal in public places and urban contexts



DISPONIBILE IN AR SU MEDIAL APP  
AVAILABLE IN AR ON MEDIAL APP



120  
L

3 Flussi / 3 Streams



1120 mm  
380 mm  
725 mm

120  
L

2 Flussi / 2 Streams



1120 mm  
380 mm  
725 mm



Chiusura a chiave triangolare  
Triangular key lock

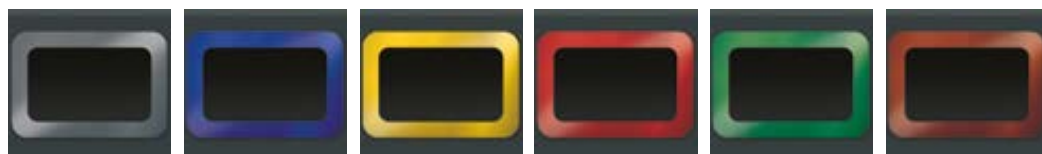

CORNICI COLORATE 295 X 200 MM  
COLORED FRAMES 295 X 200 MM

Postazione raccolta differenziata 3 flussi (3x40 L) Recycling station 3 streams (3x40 L)	789310
Postazione raccolta differenziata 2 flussi (2x60 L) Recycling station 2 streams (2x60 L)	789312
Cornice grigia Grey frame	789332
Cornice blu Blue frame	789335
Cornice gialla Yellow frame	789336
Cornice rossa Red frame	789337
Cornice verde Green frame	789338
Cornice marrone Brown frame	789339
VERONA - Posacenere murale in opzione VERONA - Mural ashtray (optional)	789390



Posacenere VERONA  
VERONA Ashtray  
REF. 789390  
(p.227)

In opzione, etichette pre-fustellate in vinile per la differenziata  
(Optional) PVC pre-cut adhesive labels for waste sorting











## STATION CITY

### Posacenere-gettacarte per la raccolta differenziata

- Acciaio galvanizzato con verniciatura epossidica da esterno
- Tre secchi interni zincati da 35 L cad. (tot. 105 L)
- Posacenere fissato con catenella di sicurezza
- Chiusura con chiave triangolare
- Fissaggio al suolo obbligatorio in 3 punti
- In opzione, etichette pre-fustellate in vinile per la differenziata (p. 193)
- Viteria di fissaggio al suolo non inclusa

### Recycling ashbin

- Powder epoxy coated galvanized steel body
- Three galvanized inner buckets 35 Lt each (105 Lt tot.)
- Ashtray fixed by a small chain
- Triangular key lock for added security
- Compulsory ground anchoring at 3 points
- As option, PVC pre-cut adhesive labels for waste sorting (p.193)
- Floor fixing kit not included



DISPONIBILE IN AR SU MEDIAL APP  
AVAILABLE IN AR ON MEDIAL APP



3x35  
L

3x50  
L

750



∅ 190 mm



Posacenere / Ashtray  
∅ 190 x h 55 mm



Sistema d'apertura  
Opening system

1080 mm

490 mm

Posacenere-gettacarte per la raccolta diff. 3x35 L  
Recycling ashbin 3x35 L

776000





## GRISÙ CITY

110  
L

Ø 190 mm

130  
L

750



### Portacenere-gettacarte antifuoco

- Acciaio galvanizzato con verniciatura epossidica da esterno
- Secchio interno zincato da 110 L
- Coperchio autoestinguente per prevenire principi d'incendio
- Posacenere fissato con catenella di sicurezza
- Chiusura con chiave triangolare
- Fissaggio al suolo obbligatorio in 3 punti
- Viteria di fissaggio al suolo non inclusa

### Fireproof ashbin

- Powder epoxy coated galvanized steel body
- Galvanized inner bucket 110 L
- Self-extinguishing lid to prevent fire from spreading
- Ashtray fixed by a small chain
- Triangular key lock for added security
- Compulsory ground anchoring at 3 points
- Floor fixing kit not included

1120 mm

490 mm



Posacenere / Ashtray  
Ø 190 x h 55 mm



Base gettacarte / Ashbin base  
Ø 200 mm



Posacenere-gettacarte antifuoco 110 L  
Fireproof ashbin 110 L

776001

## DUBAI

70  
L

Ø 190 mm

130  
L

750



### Posacenere-gettacarte

- Corpo in acciaio galvanizzato con verniciatura da esterno
- Copertura in acciaio inox AISI 430 satinato
- Coperchio con apertura a ribalta e posacenere integrato
- Secchio interno galvanizzato da 70 L
- Chiusura con chiave triangolare
- Basamento per fissaggio al suolo in 3 punti
- Viteria di fissaggio al suolo non inclusa

### Ashbin

- Powder epoxy coated galvanized steel body
- AISI 430 brushed stainless steel lid
- Side opening lid with integrated ashtray
- 70 L inner bucket from galvanized steel
- Triangular key lock for added security
- Heavy base with three ground fixing points
- Floor fixing kit not included

900 mm

450 mm



Apertura coperchio  
Lid opening



Base  
Base



DISPONIBILE IN AR SU MEDIAL APP  
AVAILABLE IN AR ON MEDIAL APP



Posacenere-gettacarte 70 L  
Ashbin 70 L

776002



## GINEVRA

### Gettacarte con posaceneri

- Struttura in acciaio trattato con cataforesi
- Verniciato con polvere epossidica per esterno
- Secchio interno in acciaio galvanizzato con maniglia
- Portaceneri e gettacarte bloccati dalla porta frontale
- Serratura con una chiave triangolare antivandalo
- Piedi d'appoggio in plastica
- Fissaggio al suolo in 2 punti (viteria inclusa)

### Ashbin

- Steel body with electrophoresis treatment
- Powder epoxy coating for outdoor use
- Galvanized inner bucket with metal handle
- Ashtray and waste bin locked by the front door
- Vandal proof triangular key lock
- Rubber pads to ensure isolation from ground
- Two ground fixing points (fixing hardware included)

48  
L

24  
L



8  
L



40  
L



940 mm  
340 mm  
483 mm



4  
L



20  
L



940 mm  
280 mm  
330 mm



Sistema d'apertura  
Opening system

Varianti colore / Colors available



Gettacarte con posaceneri grigio chiaro - grigio scuro 48 L  
Ashbin light grey - dark grey 48 L

103015

Gettacarte con posaceneri verde - silver punteggiato 48 L  
Ashbin green - dapple silver 48 L

103016

Gettacarte con posaceneri grigio manganese 48 L  
Ashbin manganese grey 48 L

103017

Gettacarte con posaceneri grigio chiaro - grigio scuro 24 L  
Ashbin light grey - dark grey 24 L

103010

Gettacarte con posaceneri verde - silver punteggiato 24 L  
Ashbin green - dapple silver 24 L

103011

Gettacarte con posaceneri grigio manganese 24 L  
Ashbin manganese grey 24 L

103018





## VERONA MURALE NEW

1,5 L



Bacinella interna 1,5 L  
Inner bucket 1,5 L



Etichetta fornita  
Supplied label

241 mm  
81 mm  
175 mm



### Posacenera murale

- Lamiera zincata verniciata colore grigio manganese (RAL 7021)
- Serratura con chiave per anti-vandalismo
- Fissaggio murale in 3 punti (viti comprese)
- Possibilità di fissaggio su Verona o Amsterdam
- Etichetta adesiva (simbolo sigaretta) fornita in confezione

### Wall mounted ashtray

- Galvanised sheet metal painted manganese grey (RAL7021)
- Vandal proof keyed lock system
- 3 mounting points (fixing kit included)
- Possibility of fixing in Verona or Amsterdam
- Adhesive label (cigarette symbol) supplied in packaging

Posacenera murale nero 1,5 L  
Wall mounted ashtray black 1,5 L

789390

## GINEVRA MURALE

1,5 L



Bacinella interna  
Inner bucket

320 mm  
85 mm  
240 mm



### Posacenera murale

- Acciaio galvanizzato con verniciatura epossidica
- Secchio interno in acciaio galvanizzato con maniglia (1,5 L)
- Serratura con chiave per anti-vandalismo
- Fissaggio murale in 4 punti (viti comprese)

### Wall mounted ashtray

- Powder epoxy coated galvanized steel body
- Removable inner bucket (1,5 L) with metal handle
- Vandal proof keyed lock system
- Four mounting points (fixing kit included)

Posacenera murale grigio chiaro - grigio scuro 1,5 L  
Wall mounted ashtray light grey - dark grey 1,5 L

103012

Posacenera murale verde - silver punteggiato 1,5 L  
Wall mounted ashtray green - dapple silver 1,5 L

103013

Posacenera murale grigio manganese 1,5 L  
Wall mounted ashtray manganese grey 1,5 L

103014

Varianti colore / Colors available



## BIRKIN MURALE

5 L



Ø 130 mm



Apertura posteriore per svuotamento  
Back hole for easy emptying



### Posacenera murale

- Acciaio inox satinato o verniciato con polvere epossidica
- Griglia interna spegni-sigaretta
- Svuotamento tramite ribaltamento del posacenera
- Serigrafia frontale con simbolo sigaretta
- Serratura con chiave per anti-vandalismo
- Fissaggio murale in 3 punti (viteria inclusa)

### Wall mounted ashtray

- Brushed stainless steel or powder epoxy coated steel body
- Stainless steel plate for putting cigarettes out
- Easy to empty by tipping the unit up
- Marked with cigarette symbol
- Vandal proof keyed lock system
- 3 wall fixing points (fixing hardware included)

Posacenera murale inox nero 5 L  
Wall mounted ashtray black s.steel 5 L

108003

Posacenera murale inox satinato 5 L  
Wall mounted ashtray brushed s.steel 5 L

108004

Varianti colore / Colors available



645 mm  
180 mm





## BIRKIN EVO

### Posacenera a colonna

- Acciaio inox verniciato con polvere epossidica
- Secchio interno con maniglia in acciaio inox
- Capacità secchio: 4,6 L (2600 mozziconi)
- L'apertura ridotta limita l'ingresso dell'acqua piovana
- Griglia frontale separa mozziconi
- Serratura con chiave per anti-vandalismo
- Piedi d'appoggio in plastica
- Design elegante
- Possibilità di fissaggio al suolo in 4 punti (viteria non inclusa)

### Floor standing ashtray

- Black powder epoxy coated steel body
- Inner bucket with stainless steel handle
- Bucket capacity: 4.6 L (2600 butts)
- Reduced opening limits rainwater entry
- Front grille for cutting butts
- Lock with key for anti-vandalism
- Plastic support feet
- Elegant design
- 4 ground fixing points (hardware not included)



∅ 129 mm

4,6  
L



Serratura  
Lock system



Apertura  
Opening



Secchio  
Bucket

1120 mm

289 mm

Posacenera a colonna inox nero 4,6 L  
Floor standing ashtray black steel 4,6 L

108021



## BIRKIN

### Posacenera a colonna

- Acciaio inox satinato o inox verniciato con polvere epossidica
- Secchio interno in acciaio inox con maniglia (4 L)
- Serratura con chiave per anti-vandalismo
- Serigrafia frontale con simbolo sigaretta
- Piedi d'appoggio in plastica
- Possibilità di fissaggio al suolo in 4 punti (viteria non inclusa)

### Floor standing ashtray

- Brushed s.steel or black powder epoxy coated steel body
- Removable inner bucket with handle (4 L)
- Vandal proof key lock system
- Marked with cigarette symbol
- Rubber pads to ensure isolation from ground
- 4 ground fixing points (hardware not included)



DISPONIBILE IN AR SU MEDIAL APP  
AVAILABLE IN AR ON MEDIAL APP



4  
L



Ø 130 mm



Ø 130 mm



Sagomato / Shaped



1000 mm  
290 mm

### Base zavorrata in opzione

Base zavorrata Ø 360 mm in plastica da 7,3 kg, con cover in inox brillante, garantisce massima stabilità al posacenera senza che vi sia bisogno di fissarlo al suolo.

### Weight base as option

Solid plastic ballast (Ø 360 mm - 7,3 kg) with polished stainless steel cover helps keep the ashtray stable in any situation, without fixing it to the ground.



Serratura  
Lock system



Secchio  
Bucket

Posacenera a colonna sagomato inox nero 4 L Shaped floor standing ashtray black steel 4 L	108006
Posacenera a colonna sagomato inox satinato 4 L Shaped floor standing ashtray brushed s.steel 4 L	108007
Posacenera a colonna inox satinato 4 L Floor standing ashtray brushed s.steel 4 L	108009
Base zavorrata Ø 360 mm Weight base Ø 360 mm	103308



## FLORA

40  
L



810 mm  
410 mm  
440 mm

60  
L

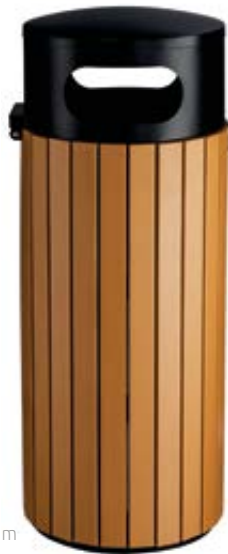

1060 mm  
410 mm  
440 mm

### Gettacarte cilindrico

- Struttura in acciaio trafilato a freddo e trattato con cataforesi
- Doppio trattamento con verniciatura epossidica anti-ruggine
- Copertura laterale in polistirene resistente ai raggi UV
- Secchio interno in acciaio galvanizzato con maniglie laterali
- Fondo perforato per facilitare il drenaggio dell'acqua
- Serratura triangolare per bloccare il coperchio
- Fissaggio al suolo in 4 punti
- Viteria in acciaio galvanizzato compresa

### Cylindrical litter bin

- Cold drawn iron plate with electrophoresis treatment
- Second layer of black powder epoxy coating for outdoor use
- Surrounding battens in polystyrene (UV and rot proof)
- Inner bucket in galvanized steel with lateral handles
- Perforated base to allow drainage of rainwater
- Vandal proof triangular keyed lock system
- Four ground fixing points
- Galvanized steel screws included



DISPONIBILE IN AR SU MEDIAL APP  
AVAILABLE IN AR ON MEDIAL APP



Gettacarte cilindrico acciaio nero-polistirene 40 L Cylindrical litter bin black steel-polystyrene 40 L	110506
Gettacarte cilindrico acciaio nero-polistirene 60 L Cylindrical litter bin black steel-polystyrene 60 L	110501

## FLORA

70  
L



850 mm  
450 mm  
450 mm

### Gettacarte quadrato

- Struttura in acciaio trafilato a freddo e trattato con cataforesi
- Doppio trattamento con verniciatura epossidica anti-ruggine
- Copertura laterale in polistirene resistente ai raggi UV
- Secchio interno in acciaio galvanizzato con maniglie laterali
- Fondo perforato per facilitare il drenaggio dell'acqua
- Serratura triangolare per bloccare il coperchio
- Fissaggio al suolo in 4 punti (viteria non compresa)

### Square litter bin

- Cold drawn iron plate with electrophoresis treatment
- Second layer of black powder epoxy coating for outdoor use
- Surrounding battens in polystyrene (UV and rot proof)
- Inner bucket in galvanized steel with lateral handles
- Perforated base to allow drainage of rainwater
- Vandal proof triangular keyed lock system
- Four ground fixing points (hardware not included)



Gettacarte quadrato acciaio nero-polistirene 70 L Square litter bin black steel-polystyrene 70 L	110516
---	--------



## SIRIO

30  
L



1040 mm  
470 mm  
330 mm

### Gettacarte

- Struttura in acciaio inox brillante
- Base in ferro verniciato nero
- Secchio da 30 L (Ø 300 mm - h 390 mm)
- Svuotamento tramite ribaltamento
- Fondo forato per l'uscita di liquidi
- Fissaggio al suolo in tre punti
- Viteria inclusa

### Litter bin

- Polished stainless steel body
- Black coated iron base
- 30 L bucket (Ø 300 mm - h 390 mm)
- Easy to empty by tipping the unit up
- Perforated base to allow drainage of rainwater
- Three ground fixing points
- Screw included

Gettacarte inox brillante 30 L  
Litter bin polished s.steel 30 L

106061

## LEM

30  
L



1150 mm  
350 mm  
575 mm

### Gettacarte

- Acciaio inox brillante qualità per esterno
- Secchio interno in acciaio galvanizzato (30 L)
- Svuotamento tramite ribaltamento
- Fondo perforato per l'uscita dei liquidi
- Fissaggio al suolo in quattro punti
- Viteria inclusa

### Litter bin

- High-quality polished stainless steel for outdoor use
- Galvanized inner bucket (30 L)
- Easy to empty by tipping the unit up
- Perforated base to allow drainage of rainwater
- Four ground fixing points
- Screw included



Sistema di svuotamento  
Emptying system

Gettacarte inox brillante 30 L  
Litter bin polished s.steel 30 L

106062



## POLIS

35  
L



460 mm  
340 mm

1200 mm  
30 mm  
55 mm



Palo da interrare  
Post for ground fixing



### Gettacarte

- Struttura in acciaio zincato
- Finitura con vernice poliester o protettiva trasparente
- Svuotamento tramite ribaltamento del cestino
- Elastico fermasacco
- Fissaggio murale o su palo

### Litter bin

- Galvanized steel body
- Finished with polyester or transparent protective varnish
- Easy to empty by tipping the unit up
- Bag held in place by stretch band
- Wall or pole mounting

Varianti colore / Colors available



Gettacarte acciaio zincato con vernice trasparente 35 L Litter bin zinc plated steel with transparent varnish 35 L	778030
Gettacarte acciaio zincato grigio manganese 35 L Litter bin manganese grey coated zinc plated steel 35 L	778036
Gettacarte acciaio zincato verde 35 L Litter bin green coated zinc plated steel 35 L	778037
Palo zincato Zinc plated post	778031

## MILUNA

40  
L



647 mm  
195 mm  
395 mm

20  
L



388 mm  
195 mm  
395 mm



### Gettacarte

- Acciaio galvanizzato con verniciatura poliester
- Fondo perforato per facilitare il drenaggio dell'acqua
- Elastico fermasacco
- Fissaggio su palo o murale
- Viteria per fissaggio murale non inclusa

### Litter bin

- Polyester powder coated galvanized steel
- Perforated base to allow drainage of rainwater
- Bag held in place by stretch band
- Wall or pole mounting
- Fixing kit not included

Gettacarte grigio manganese 20 L Litter bin manganese grey 20 L	778051
Gettacarte grigio manganese 40 L Litter bin manganese grey 40 L	778061
Palo grigio manganese Manganese grey post	778011





## PIVO

### Gettacarte

- Acciaio galvanizzato verniciato poliesteri
- Svuotamento tramite ribaltamento del cestino
- Fondo perforato per facilitare il drenaggio dell'acqua
- Fissaggio murale o su palo
- Elastico fermasacco
- Placca fissaggio murale per vers. rettangolare in opzione
- Staffa fissaggio portaceneri "Nido" in opzione

### Litter bin

- Polyester powder coated galvanized steel
- Easy to empty by tipping the unit up
- Perforated base to allow drainage of rainwater
- Wall or pole mounting
- Bag held in place by stretch band
- Rectangular bracket for wall-mounting fixing on request
- "Nido" ashtray holder on request



22  
L



390 mm  
290 mm

24  
L



400 mm  
197 mm  
300 mm

Palo da interrare  
Post for ground fixing



Facile sistema di svuotamento  
Easy to empty by tipping the bucket up



Staffa in opzione per fissaggio  
murale mod. rettangolare  
Wall mounting bracket for  
rectangular bins



Staffa fissaggio portaceneri Nido  
Nido ashtray holder

1200 mm  
30 mm  
55 mm

Varianti colore / Colors available



	Grigio manganese Manganese Grey	Verde Green	Inox AISI 304 AISI 304 s.steel
Gettacarte cilindrico 22 L Cylindrical litter bin 22 L	778001	778002	
Gettacarte rettangolare 24 L Rectangular litter bin 24 L	778021		
Palo per gettacarte Litter bin post	778011		
Staffa fissaggio murale per modello rettangolare Wall-mounted bracket for rectangular version	778025		
Staffa fissaggio portaceneri Nido Nido ashtray holder			778026



## CLASSIC

### Gettacarte

- Polipropilene (PP)
- Resistente ai raggi UV, al calore, al freddo e agli agenti chimici
- Piastra spegni-sigaretta in acciaio inox
- Fondo perforato per facilitare il drenaggio dell'acqua
- Svuotamento mediante sganciamento del gettacarte
- Chiusura con chiave triangolare e kit per fissaggio murale incluso
- In opzione, palo in acciaio zincato (Ø 60 mm - H 1200 mm)

### Litter bin

- Polypropylene (PP)
- Resistant to UV, cold, heat and chemicals
- Stainless steel plate to put cigarettes out
- Perforated base to allow drainage of rainwater
- Easy to empty and clean
- Vandal proof triangular keyed lock system and wall-mount fixing in 4 points included
- Post in zinc plated steel sold separately (Ø 60 mm - H 1200 mm)

50 L

60 L



Varianti colore  
Colors available



790 mm  
248 mm  
440 mm

Palo da  
interrare  
Post for  
ground fixing

1200 mm  
60 mm



Gettacarte polipropilene verde 50 L Litter bin green polypropylene 50 L	102050
Gettacarte polipropilene grigio 50 L Litter bin grey polypropylene 50 L	102051
Palo in acciaio zincato Zinc plated steel post	778016

## TRESPY



### Gettacarte portasacco

- Portasacco 110 L in HDPE 100% riciclabile
- Anello fermasacco integrato
- Particolarmente adatto per la raccolta differenziata
- Economico, pratico, versatile, leggero e di semplice utilizzo
- Disponibile in colorazioni differenti

### Bag holder litter bin

- Bag holder 110 L 100% recyclable HDPE
- Integrated heel clip ring
- Cheap, practical, adaptable, light and easy to use
- Particularly suitable for differential waste collection
- Available in different colours

110 L

110 L



Ø 380 mm

850 mm  
510 mm

Varianti colore  
Colors available



plastic  
second life

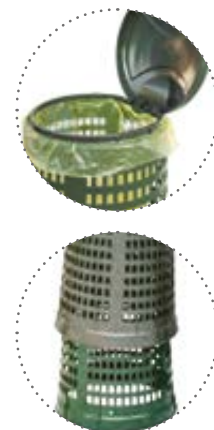

	Verde Green	Grigio Grey	Grigio-Blu Grey-Blue	Grigio-Giallo Grey-Yellow	Grigio-Rosso Grey-Red	Grigio-Verde Grey-Green
Gettacarte portasacco 110 L Bag holder litter Bin 110 L	720503	720500	720505	720506	720507	720508





## SNUPY

### Distributore di sacchetti per deiezioni canine

- Acciaio inox o galvanizzato a caldo; finitura satinata o verniciatura epossidica
- Foro frontale per l'erogazione dei sacchetti; (Capacità max: 600 sacchetti)
- Chiusura con chiave triangolare
- 2 adattatori in inox AISI 304 per fissaggio su palo Ø 60 mm (in opzione)
- Palo (Ø 60 mm - h 230 cm) + cartello segnaletico in opzione

### Dog waste bags dispensers

- Stainless steel or hot-dip galvanized steel; brushed or epoxy coated finish
- Bags are dispensed through frontal hole; capacity: 600 bags max
- Triangular key lock for added security
- 2 brackets from s.steel AISI 304 for post mounting Ø 60 mm (sold separately)
- Post (Ø 60 mm - H 230 cm) + info board sold separately



400 mm  
65 mm  
270 mm

Varianti colore / Colors available

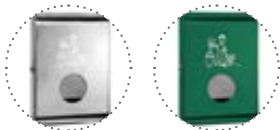

Kit per palo  
Bracket for post  
Ø 60 mm

	Verde Green	Inox satinato Brushed s.steel	Inox AISI 304 AISI 304 s.steel
Distributore di sacchetti Dog waste bag dispenser	103071	103070	
Coppia adattatori fissaggio a palo Ø 60 mm Two brackets for post mounting Ø 60 mm			103077
Palo verde h 230 cm Green coated post h 230 cm	103076		
Pannello segnaletico Info board	103078		

### Sacchetti per deiezioni canine

- Polietilene ad alta densità
- Ricarica da 100 sacchetti
- Cartone da 10 ricariche (tot. 1000 pz)

### Dog waste bags

- High-density polyethylene
- 100 bags per bundle
- 10 bundles per carton (1000 pcs tot)

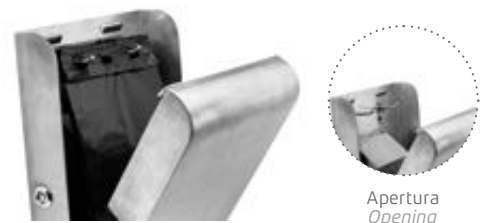

Sacchetti per deiezione canina HDPE  
HDPE Dog waste bags

103075





## TONDO

### Reggisacco e reggisacco con coperchio

- Acciaio galvanizzato con verniciatura poliesteri
- Cinghia reggisacco in neoprene
- Fissaggio a muro o su palo
- Bulloneria inclusa

### Sack holder and sack holder with lid

- Polyester powder coated steel body
- Bag held securely by elastic belt
- Wall or post mounted fixing
- Fixing hardware included



Varianti colore / Colors available



150 mm  
535 mm  
415 mm

Varianti colore / Colors available



150 mm  
528 mm  
383 mm

	Blu Blue	Grigio manganese Manganese Grey	Verde Green	Giallo Yellow	Rosso Red
Portasacco Bag holder	601001	601002	601003	601004	601005
Portasacco con coperchio Bag holder with lid	601011	601012	601013	601016	601015



## TONDO

### Supporto murale e adattatori per palo tondo (non fornito)

- Acciaio galvanizzato con verniciatura poliesteri
- Bulloneria non compresa

### Wall bracket and round post adapters (not included)

- Polyester powder coated galvanized steel body and lid
- Bolts not included

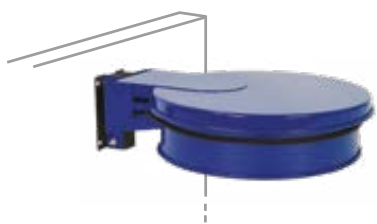

Supporto murale  
Wall bracket

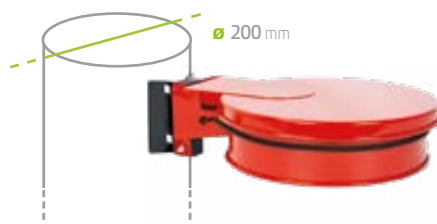

Adattatore per palo  
rotondo Ø 200 mm  
Adapter for  
Ø 200 mm post

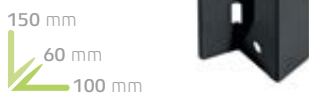

Adattatore per palo  
rotondo Ø 50/60 mm  
Adapter for  
Ø 50/60 mm post

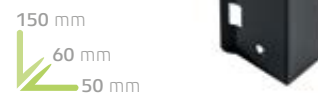

	Blu Blue	Grigio manganese Manganese Grey	Verde Green
Supporto murale Wall mounting holder	601006	601007	601008
Adattatore per palo Ø 200 mm Adapter for Ø 200 mm post		601052	
Adattatore per palo Ø 50/60 mm Adapter for Ø 50/60 mm post		601057	

## TONDO

### Accessori

- Acciaio galvanizzato con verniciatura poliesteri
- Bulloneria compresa

### Accessories

- Powder epoxy coated galvanized steel body and lid
- Bolts included

N.B.: Applicabile  
una sola griglia per palo  
N.B.: Applicable  
one grid per pole

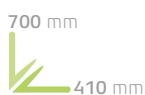
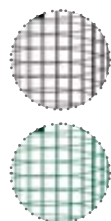

Pannello informativo  
Info board

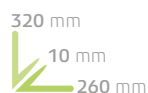

	Grigio manganese Manganese Grey	Verde Green
Griglia per reggisacco Grid for sack holder	601082	601083
Pannello informativo Info board	601035	





## TONDO

### Pali, supporti e accessori

- Acciaio galvanizzato con verniciatura poliesteri
- Bulloneria compresa

### Posts, holders and accessories

- Powder epoxy coated galvanized steel body and lid
- Bolts included



Palo da interrare - Ground fixing post



1270 mm  
30 mm  
50 mm

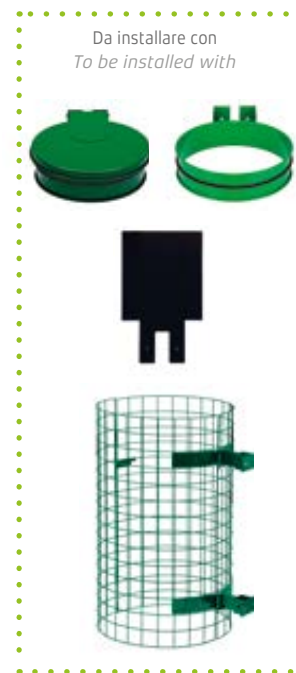

Grigio manganese  
Manganese Grey

Palo da interrare  
Ground fixing post

601028

Palo su base per aggancio singolo  
On stand base (single holder)



920 mm  
440 mm  
440 mm

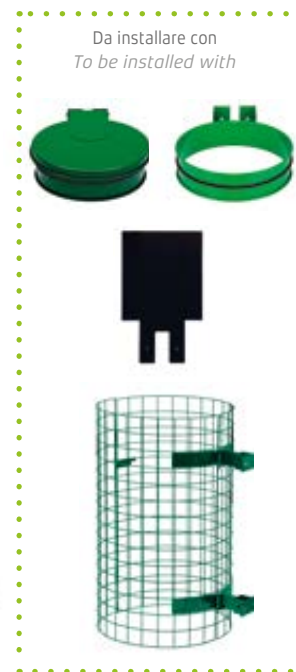

Grigio manganese  
Manganese Grey

Palo su base (aggancio singolo)  
Free-standing base (single holder)

601025



Palo con piastra per aggancio singolo  
*Ground fixing base post (single holder)*

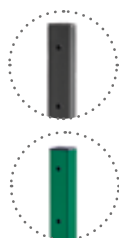

1010 mm  
280 mm

Da installare con  
*To be installed with*

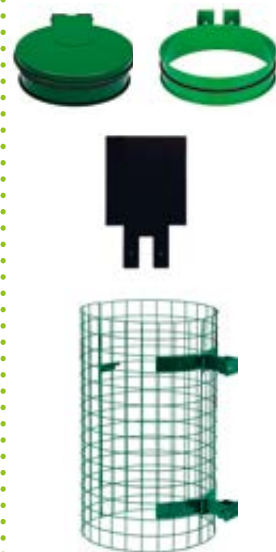

Grigio manganese <i>Manganese Grey</i>	Verde <i>Green</i>
601038	601039

Palo con piastra  
*Post with ground fixing base*



Palo su base per doppio / triplo aggancio  
*Post & base for double / triple holder*

920 mm  
680 mm  
440 mm

Da installare con  
*To be installed with*



Supporto su palo per doppio aggancio  
*Post bracket with double holder*

150 mm  
40 mm  
80 mm



Supporto su palo per triplo aggancio  
*Post bracket with triple holder*

200 mm  
160 mm

Palo su base per doppio o triplo aggancio  
*Post & base for double or triple holder*

Grigio manganese  
*Manganese Grey*

601030
601062
601020T



## CONTIVIA 2

### Contenitori in plastica 2 ruote

- Polietilene ad alta densità (HDPE) con protezione anti UV
- Realizzato utilizzando il processo di stampaggio a iniezione
- Assorbe gli urti, resiste ai prodotti chimici e ai grandi sbalzi termici
- Assale delle ruote in acciaio zincato
- Ruote in gomma Ø 200 mm, portata 100 kg / ruota
- Conforme alla norma DIN 30740 / EN 840
- Pedale in opzione solo per 120 L
- Anello fermasacco in opzione per 120 L

### Plastic waste container on 2 wheels

- HDPE in an injection moulding process with UV treatment
- Manufactured using the injection moulding process
- Water, frost and heat resistant, also withstands many chemicals
- Sturdy galvanized steel wheel axle
- Rubber wheels Ø 200 mm, load capacity 100 kg / wheel
- Manufactured according to DIN 30740 / EN 840
- Pedal for 120 L only, optional
- Sack holder for 120 L cont. sold separately



120  
L



240  
L



360  
L

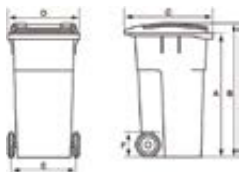

	A (mm)	B (mm)	C (mm)	D (mm)	E (mm)	F (mm)	Peso Weight	Carico utile (Kg) Maximum load
120 L	875	927	543	480	480	200	10,4	48
240 L	1007	1062	715	557	573	200	14,2	96
360 L	1010	1098	880	601	580	200	20	160

### Varianti colore / Colors available



Profilo rifrangente  
in PVC adesivo  
Reflecting profile



Pedale in opzione  
Pedal as option

	120 L	240 L	360 L
Contenitore grigio Grey container	766610	766620	766630
Contenitore giallo Yellow container	766611	766621	766631
Contenitore blu Blue container	766612	766622	766632
Contenitore verde Green container	766613	766623	766633
Contenitore marrone Brown container	766614	766624	766634
Contenitore bianco White container	766615	766625	
Pedale in opzione Pedal on request	766900		
Profilo rifrangente destro Right refracting profile	766941	766941	766941
Profilo rifrangente sinistro Left refracting profile	766942	766942	766942
Anello fermasacco Sack holder	766910		



## CONTIVIA 4

### Contenitori in plastica 4 ruote

- Polietilene ad alta densità (HDPE) con protezione anti UV
- Realizzato utilizzando il processo di stampaggio a iniezione
- Resistente a sbalzi termici, urti, corrosione e alle sostanze chimiche
- Ruote in gomma Ø 200 mm
- Ruote con anello in gomma per un utilizzo intensivo, 2 con freno
- Parti metalliche zincate resistenti alla corrosione
- Maniglie poste su 3 lati
- Conforme alla norma DIN 30740 / EN 840
- Svuotamento con sistema a pettine o DIN Standard

### Plastic waste container on 4 wheels

- HDPE in an injection moulding process with UV treatment
- Manufactured using the injection moulding process
- Resistant to temperature changes, shocks, corrosion and chemicals
- Rubber wheels Ø 200 mm
- Heavy-duty rubber-tyred wheels, 2 with brake
- Corrosion-resistant galvanised metal parts
- Handles on 3 sides
- Manufactured according to DIN 30740 / EN 840
- To be emptied by tipping over a toothed rim as a standard feature



	A (mm)	B (mm)	C (mm)	D (mm)	E (mm)	F (mm)	H ø (mm)	Peso Weight	Carico utile (Kg) Maximum load
660 L	1130	1215	784	1370	880	481	200	45	270
770 L	1275	1355	784	1370	880	608	191	47	310
1100 L	1215	1295	1118	1370	850	750	200	58	450

### Varianti colore / Colors available



Profilo rifrangente in PVC adesivo  
Reflecting profile



Ruote insonorizzate  
Soundproofed wheels

	660 L	770 L	1100 L
Contenitore grigio Grey container	766640	766650	766660
Contenitore giallo Yellow container	766641	766651	766661
Contenitore blu Blue container	766642	766652	766662
Contenitore verde Green container	766643	766653	766663
Contenitore marrone Brown container	766644	766654	766664
Profilo rifrangente destro Right refracting profile	766941	766941	766941
Profilo rifrangente sinistro Left refracting profile	766942	766942	766942





## CONTIVIA BASIC 2

NEW

### Contenitori in plastica 2 ruote

- Polietilene ad alta densità (HDPE) con protezione anti UV
- Assorbe gli urti, resiste ai prodotti chimici e ai grandi sbalzi termici
- Coperchio con apertura a libro e bordo anti infiltrazione, sede per alloggiamento microchip
- Ruote in gomma Ø 200 mm
- Conforme alla norma DIN 30740 / EN 840
- Pedale + anello fermasacco in opzione per 120 L e 240 L

### Plastic waste container on 2 wheels

- HDPE in an injection moulding process with UV treatment
- Water, frost and heat resistant, also withstands many chemicals
- Lid with book opening and anti-infiltration edge, seat for microchip housing
- Rubber wheels Ø 200 mm
- Manufactured according to DIN 30740 / EN 840
- Pedal + Sack holder for 120 L or 240 L, optional



120 L



240 L



360 L

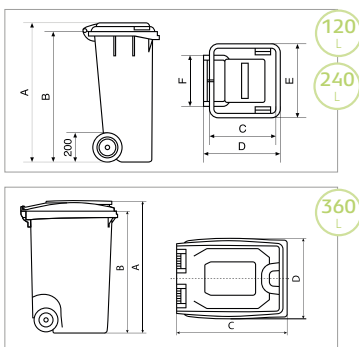

	A (mm)	B (mm)	C (mm)	D (mm)	E (mm)	F (mm)	Peso Weight	Carico utile (Kg) Maximum load
120 L	930	875	485	550	480	355	9 kg	60 kg
240 L	1070	995	655	730	580	420	13 kg	116 kg
360 L	1099	1015	880	596	-	-	15,5 kg	160 kg

### Varianti colore / Colors available

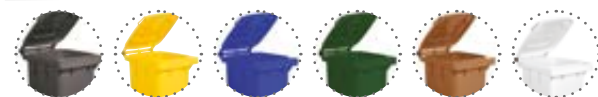

Profilo rifrangente in PVC adesivo  
Refracting profile

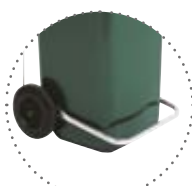

Pedale in opzione  
Pedal as option



Anello Fermasacco  
Sack holder

	120 L	240 L	360 L
Contenitore grigio Grey container	720010	720020	720030
Contenitore giallo Yellow container	720011	720021	720031
Contenitore blu Blue container	720012	720022	720032
Contenitore verde Green container	720013	720023	720033
Contenitore marrone Brown container	720014	720024	
Contenitore bianco White container	720015	720025	
Pedale + anello fermasacco in opzione Pedal + sack holder on request	720001	720002	
Profilo rifrangente destro Right refracting profile	766941	766941	766941
Profilo rifrangente sinistro Left refracting profile	766942	766942	766942





## CONTIVIA BASIC 4



### Contenitori in plastica 4 ruote

- Polietilene ad alta densità (HDPE) con protezione anti UV
- Resistente a sbalzi termici, urti, corrosione e alle sostanze chimiche
- Ruote in gomma Ø 200 mm
- Ruote con anello in gomma per un utilizzo intensivo, 2 con freno
- Coperchio piano con apertura a libro ed impugnatura a labbro
- Bordo anti infiltrazione, sede per alloggiamento microchip
- Maniglie ergonomiche per la movimentazione
- Tappo sul fondo per una corretta pulizia e sanificazione
- Conforme alla norma DIN 30740 / EN 840

### Plastic waste container on 4 wheels

- HDPE in an injection moulding process with UV treatment
- Resistant to temperature changes, shocks, corrosion and chemicals
- Rubber wheels Ø 200 mm
- Heavy-duty rubber-tyred wheels, 2 with brake
- Flat lid with folding opening and lip handle
- Anti-seepage edge, seat for microchip housing
- Ergonomic handles for handling
- Cap on bottom for proper cleaning and sanitization
- Manufactured according to DIN 30740 / EN 840

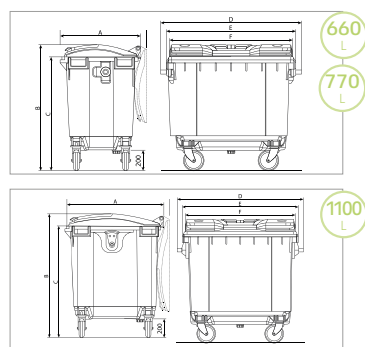

	A (mm)	B (mm)	C (mm)	D (mm)	E (mm)	F (mm)	Peso Weight	Carico utile (Kg) Maximum load
660 L	778	1228	1105	1370	1270	1200	40 kg	310 kg
770 L	778	1365	1243	1370	1270	1200	43 kg	360 kg
1100 L	1070	1344	1280	1370	1270	1200	50 kg	510 kg

### Varianti colore / Colors available



Profilo rifrangente  
in PVC adesivo  
Reflecting profile



Kit pedale in opzione  
Pedal kit as option

	660 L	770 L	1100 L
Contenitore grigio Grey container	720040	720050	720060
Contenitore giallo Yellow container	720041	720051	720061
Contenitore blu Blue container	720042	720052	720062
Contenitore verde Green container	720043	720053	720063
Kit pedale in opzione Pedal kit as option	720003	720004	720005
Profilo rifrangente destro Right refracting profile	766941	766941	766941
Profilo rifrangente sinistro Left refracting profile	766942	766942	766942

## GUIDA AI MATERIALI, ALLE LAVORAZIONI E ALLE FINITURE

In questa sezione, siamo lieti di presentare una breve guida che descrive le caratteristiche dei materiali e delle lavorazioni utilizzate per produrre i nostri articoli. Siamo infatti convinti che l'efficacia di una vendita dipenda soprattutto dalla completezza delle informazioni condivise con il cliente, per consentirgli di effettuare una scelta d'acquisto critica e consapevole.

### PLASTICHE



#### **ABS**

L'ABS è una resina termoplastica ottenuta tramite polimerizzazione di acrilonitrile, butadiene e stirene. Oltre ad essere altamente riciclabile, l'ABS presenta un'elevata resistenza ad urti, scalfitture ed abrasioni. Quanto invece alla sua resistenza chimica, l'ABS ben sopporta la corrosione di sostanze, come l'acqua, le soluzioni saline, gli acidi, le soluzioni alcaline, gli idrocarburi saturi (benzina) e gli oli minerali. Scelto per realizzare le nostre linee di accessori bagno, questo materiale garantisce massimi livelli di igiene e facile manutenzione.

#### **ABS**

ABS is a thermoplastic resin derived from acrylonitrile, butadiene and styrene polymerization. Besides being highly recyclable, ABS is also highly-resistant to impacts, scratching and abrasions. As for its chemical resistance, ABS withstands corrosion of substances, such as water, saline solutions, acids, alkaline solutions, saturated hydrocarbons (gasoline) and mineral oils. All these features make ABS the ideal material for our range of bathroom accessories and ensure a high level of hygiene and easy maintenance.



#### **POLIETILENE (PE)**

Il polietilene è una resina termoplastica ottenuta per polimerizzazione dell'etilene. Questo materiale presenta buone proprietà meccaniche, essendo altamente resistente alla trazione, alla flessione, all'abrasione e all'impatto. Quanto invece alla sua resistenza chimica, è impermeabile all'acqua ed è resistente alla corrosione di agenti chimici, in particolare alle soluzioni saline, agli acidi, alcali, alcool e benzina. Può essere però intaccato da acidi ossidanti quali acido nitrico, acido solforico e dagli alogeni. Infine, oltre ad essere altamente riciclabile, il polietilene presenta un'elevata resistenza agli agenti atmosferici, il che rende questo materiale ideale per la produzione di contenitori per l'esterno.

#### **POLYETHYLENE (PE)**

Polyethylene is a thermoplastic resin derived from ethylene polymerization. Polyethylene has good mechanical properties, resulting in high tensile, flexural, abrasion and impact strength. As for its chemical resistance, it is impermeable to water and it is resistant to corrosion by chemical agents, such as saline solutions, acids, alkali, alcohol and gasoline. It may be affected by oxidizing acids such as nitric, sulfuric and halogens acids. In addition to being highly recyclable, polyethylene offers a high weathering resistance that makes this material ideal for the production of outdoor waste bins and containers.



#### **POLIPROPILENE (PP)**

Il polipropilene è una resina termoplastica ottenuta per polimerizzazione del propilene. Grazie alla sua struttura parzialmente cristallina, questo materiale risulta rigido ma leggero. Per quanto riguarda le sue caratteristiche meccaniche, il polipropilene presenta scarsa deformabilità, buona resistenza ai carichi, alla trazione, all'impatto e all'abrasione. Tra le proprietà chimiche, invece, si evidenzia la resistenza alla corrosione da parte di soluzioni acquose saline, acidi deboli, soluzioni alcaline, alcool, alcuni olii e soluzioni di lavaggio, mentre non resiste a forti agenti ossidanti e idrocarburi alogenati.

#### **POLYPROPYLENE (PP)**

Polypropylene is a thermoplastic derived from propylene polymerization. Due to its crystalline structure, this material is rigid yet lightweight. As for its mechanical properties, polypropylene is resistant to loads, tensile, impact and abrasion. Regarding its chemical properties, this material is resistant to corrosion by saline aqueous solutions, weak acids, alkaline solutions, alcohol, certain oils and washing solutions, while it is not resistant to strong oxidizing and halogenated hydrocarbons agents.



## MATERIALS, PROCESSING AND FINISHINGS GUIDE

This short guide describes the raw material features and the types of processing used in our products' manufacturing. We indeed believe that sale effectiveness depends on information sharing with customers, enabling people to take more conscious and critical purchasing decisions.

### PLASTICS



#### POLIMETACRILATO (PMMA)

Altamente noto come Plexiglas®, il polimetacrilato è un materiale plastico composto da polimeri di metacrilato. Particolarmente apprezzato per la sua leggerezza, questo materiale è richiesto per la sua infrangibilità. Il polimetacrilato presenta infatti buona resistenza alla trazione, alla compressione e alla flessione. Risulta invece più sensibile alle abrasioni. Il polimetacrilato vanta anche eccellenti qualità ottiche, essendo caratterizzato da una grande permeabilità alla luce. Per le sue proprietà tecniche, le lastre in polimetacrilato vengono spesso utilizzate in alternativa al vetro, specialmente per la produzione di specchi, articoli di sicurezza e presidi antinfortunistici.

#### POLYMETHACRYLATE (PMMA)

Also known as Plexiglas®, the polymethacrylate is composed of methacrylate polymers. Particularly appreciated for its light weight, this material is also unbreakable. In fact, polymethacrylate has a good tensile, compressive and bending resistance. On the other hand, it is more sensitive to abrasion. Polymethacrylate is characterized by a great light transmission. Thanks to its technical properties, the polymethacrylate sheets are often used as an alternative to glass, especially for the production of mirrors, safety and accident prevention items.



#### POLICARBONATO (PC)

Il policarbonato è un polimero ottenuto dalla policondensazione di bisfenolo A (BPA) e un carbonato o un fosgene. Oltre a presentare eccellenti proprietà meccaniche ed elevata trasparenza, questo materiale ha caratteristiche molto simili al polimetilmetacrilato (PMMA, acrylic), con in più una maggiore resistenza alle alte temperature.

#### POLYCARBONATE (PC)

Polycarbonate is a polymer obtained from the polycondensation of bisphenol A (BPA) and a carbonate or phosgene. It offers excellent mechanical properties. Polycarbonate characteristics are close to those of polymethylmethacrylate (PMMA, acrylic), with in addition a high temperature resistance. Polycarbonate offers very high transparency. Thanks to its excellent impact resistance, it is also used in the manufacture of motorcycle helmets and police shields.



#### POLISTIRENE ESTRUSO (XPS)

Il polistirene estruso è un polimero termoplastico derivato dallo stirene. Presenta elevata resistenza agli urti e agli agenti atmosferici. Risulta tinto in massa e resistente ai raggi UV, motivo per il quale è utilizzato per produrre articoli destinati ad uso esterno.

#### EXTRUDED POLYSTYRENE (XPS)

Polystyrene is a thermoplastic polymer produced from styrene. It possesses a high impact and weathering resistance. It is also dyed and resists to UV, therefore this material is ideal for producing products for outdoor use.



Fe

**ACCIAIO (Fe)**

Composto essenzialmente da ferro e carbonio, l'acciaio è una lega presente in varie qualità e gradi. A seconda della composizione chimica e del processo di lavorazione cui è sottoposto, questo materiale acquisisce proprietà e caratteristiche differenti. In generale, qualunque tipo d'acciaio presenta ottime proprietà chimiche e meccaniche, essendo resistente alla trazione, alla flessione, all'abrasione, all'impatto e alla corrosione.

**STEEL (Fe)**

Steel is an alloy consisting mostly of iron, carbon and other elements. Its properties result from both chemical composition and manufacturing process. Despite being available in several qualities and grades, any type of steel has outstanding mechanical and chemical properties, such as strength, durability and resistance to both impacts and corrosion.

**ACCIAIO INOSSIDABILE**

"Acciaio inossidabile" è il termine utilizzato per identificare un gruppo specifico di acciai a base ferrosa, la cui peculiarità è quella di contenere una bassa percentuale di carbonio ( $\leq 1,2\%$ ) ed un elevato tenore di cromo ( $\geq 10,5\%$ ). All'interno di questa lega, conosciuta anche come inox, sono presenti varie quantità di altri elementi. A seconda delle percentuali con cui questi vengono combinati in lega, gli acciai inossidabili si dividono in varie famiglie e sottocategorie. Medial International pone grande attenzione nella selezione degli inox, utilizzando i seguenti gradi: AISI 201, AISI 304, AISI 430. L'acciaio inossidabile è particolarmente apprezzato, oltre che per le sue qualità estetiche e per l'eco-compatibilità, per la resistenza ai carichi, alla trazione, all'impatto, all'abrasione. Ma la caratteristica più peculiare dell'inox è la sua resistenza alla corrosione. Gli elementi chimici presenti in lega - in particolare il cromo - reagiscono con l'ossigeno presente nell'ambiente circostante, generando un sottile film protettivo che aiuta a proteggere il materiale sottostante dall'attacco di agenti esterni. Ogni qualvolta viene scalfito o danneggiato, lo strato di passivazione si auto-rigenera immediatamente, tornando allo stato originale. Ciò nonostante la durata dell'inox nel tempo - a prescindere dal tipo di grado - dipende da una regolare manutenzione e pulizia delle sue superfici.

**STAINLESS STEEL**

"Stainless steel" is a collective term used to identify a special group of iron-based alloys, containing at least 1,2% carbon and 10,5% chromium, and other elements. Depending on the amount of the constituents in the alloy, stainless steel can be categorized in several families and subcategories. Medial International pays great attention in selecting the best stainless steels. We make use of the following stainless steel grades: AISI 201, AISI 304, AISI 430. Stainless steel is appreciated for its aesthetic qualities, as well as its strength, durability and eco-compatibility since it is 100% recyclable. But one of its most distinctive features concerns its corrosion-resistance. Stainless steel has indeed a unique self-healing property. By combining with Nickel and Molybdenum, Chrome forms a thin protective layer on surface with the assistance of Oxygen from air or water. If this thin layer is scratched, it immediately rebuilds, keeping protecting the surface from corrosion. However, the durability of stainless steel over time, whatever grades is concerned, is related to a regular maintenance and cleaning.

Inox



RESISTENZA ALLA CORROSIONE CORROSION RESISTANCE	Acciaio Inox / Stainless Steel		
	AISI 430	AISI 201	AISI 304
	Ferritico Ferritic	Austenitico Austenitic	Austenitico Austenitic
<i>CONTESTI / ENVIRONMENTS</i>			
Contesti urbani / City environments	●	●	●
Atmosfere d'acqua dolce / Moist environments	●	●	●
Atmosfera marina / Salt water environments	●	●	●
<i>SOSTANZE / SUBSTANCES</i>			
Acido acetico / Acetic acid (0-20%)	●	●	●
Acetone puro / Pure acetone	●	●	●
Acido citrico / Citric acid (5%)	●	●	●
Acido cloridrico / Hydrochloric acid	●	●	●
Acido fluoridrico / Hydrofluoric acid	●	●	●
Acido lattico / Lactic Acid	●	●	●
Acido muriatico / Muriatic acid	●	●	●
Acido solforico / Sulfuric acid	●	●	●
Acido solforoso / Sulphurous acid	●	●	●
Anidride carbonica / Carbon dioxide	●	●	●
Anidride solforosa / Sulphur dioxide	●	●	●
Ammoniaca / Ammonia	●	●	●
Benzina / Petrol	●	●	●
Bicarbonato di sodio / Baking soda	●	●	●
Bisolfato di sodio / Sodium bisulfate	●	●	●
Candeggina / Bleach	●	●	●
Cloroformio / Chloroform	●	●	●
Cloruro ferrico e ferroso / Ferric & ferrous chloride	●	●	●
Cloruro d'ammonio e di potassio / Ammonium & potassium chloride	●	●	●
Ipoclorito di calcio e sodio / Calcium & sodium hypochlorite	●	●	●
Olii vegetali (caldi e freddi) / Vegetable oils (hot and cold)	●	●	●
Sapone neutro / Soap	●	●	●
Solfati (alluminio-ammonio-magnesio) / Sulfates (aluminum-magnesium-ammonium)	●	●	●
Trielina / Trichlorethylene	●	●	●

LEGENDA / KEY:

- = Eccellente resistenza / Outstanding resistance
- = Buona resistenza / Good resistance
- = Sufficiente resistenza / Limited resistance
- = Evitare / Not recommended

\* Per ulteriori informazioni, consultare le specifiche guide nella sezione prodotti sul nostro sito [www.medialinternational.com](http://www.medialinternational.com)  
 \* For further information, please consult the dedicated guides you will find in "products" section on our website [www.medialinternational.com](http://www.medialinternational.com)



**GALVANIZZAZIONE**

La galvanizzazione è un processo che prevede l'applicazione di un rivestimento di zinco su un metallo per impedirne l'ossidazione. Il tipo di zincatura utilizzato è quello a caldo, che si effettua immergendo un metallo (ferro o acciaio) in una vasca contenente zinco fuso. In queste condizioni, sulla superficie del metallo ha luogo la formazione di diversi strati protettivi. Il meccanismo protettivo dello strato che si viene così a formare è duplice. Oltre a costituire una barriera fisica che rallenta i processi di corrosione e deterioramento della superficie del metallo, lo zinco agisce con meccanismo elettrochimico: qualora la verniciatura si danneggi, lasciando scoperte porzioni del materiale sottostante, lo zinco circostante agisce come anodo di sacrificio evitando la formazione di ruggine sul metallo.

**GALVANIZATION**

Galvanization is a process that involves the application of a zinc coating on a metal surface to prevent its oxidation. The most common process is hot-dip galvanization, which is carried out by immersing metal (iron or steel) in a bath of liquid zinc to produce a corrosion resistant, multi-layered coating of zinc-iron alloy and zinc metal. The coating forms an equal thickness on all surfaces immersed in the galvanizing kettle. This process provides a long-lasting, maintenance-free protection that slows the processes of corrosion and surface deterioration. If coating is damaged, leaving uncovered portions of the underlying material, the zinc coating acts as a sacrificial anode to avoid the formation of rust on the metal.

**CATAFORESI**

La cataforesi è un trattamento superficiale di verniciatura dei manufatti per immersione, collegati al polo negativo di un generatore elettrico, in una vasca ove sono immersi anche alcuni elettrodi collegati al polo positivo. Il campo elettrico ed i fenomeni elettrochimici che si sviluppano, determinano la deposizione e la solidificazione della vernice sul pezzo. In questo modo, le particelle vengono applicate uniformemente su tutta la superficie immersa. Inoltre, l'omogeneità del rivestimento fornisce buoni livelli di legame e ottima resistenza alla corrosione anche in quelle aree che sono difficili da raggiungere con i tradizionali metodi di verniciatura. Se il rivestimento viene danneggiato, lasciando porzioni scoperte del materiale sottostante, il primo strato di vernice funge da protezione evitando la formazione di ruggine sul metallo. Questo trattamento è infatti molto adatto per prodotti verniciati per uso esterno.

**CATAPHORESIS**

Cataphoresis is a painting technique that consists in immersing the part in a bath of water-soluble paint, connected to a cathode and by migrating particles of paint in suspension in the bath by means of an electric current of a certain tension, from the anode to the cathode. The paint particles are then applied evenly and over substantially the entire surface of the immersed part. Furthermore, the homogeneity of the coating provides good bonding layers and excellent corrosion resistance even to those areas which are hard to reach with traditional methods. If coating is damaged, leaving uncovered portions of the underlying material, the primary layer of painting acts to avoid the formation of rust on the metal. This treatment is indeed very suitable for varnishing products for outdoor use.

## VERNICI

## COATINGS

**VERNICI EPOSSIDICHE**

Le vernici epossidiche sono resine in grado di creare un rivestimento plastico che protegge i manufatti metallici da agenti chimici. Queste vernici presentano un'elevata resistenza meccanica ed una buona resistenza alla corrosione di agenti chimici. Il film che viene a crearsi in seguito ai processi di verniciatura risulta duro e lievemente opaco.

**POWDER EXPOSY COATING**

Powder Epoxy Coating is a type of coating that consists in applying electro-statically dry powder and cured under heat to allow it to flow and form a hard thin layer. They have great mechanical strength and good resistance to corrosion by agents such as acids. Furthermore, the coating is hard and slightly opaque.



## PULIZIA E MANUTENZIONE GENERALE DELLE SUPERFICI\*

## GENERAL SURFACE CLEANING AND MAINTENANCE\*

### PLASTICA

### PLASTICS

Le superfici plastiche richiedono una pulizia periodica, da effettuare con un panno morbido, imbevuto d'acqua. Se questo non bastasse, si consiglia di utilizzare un prodotto specifico per la cura della plastica. Prestare attenzione ai detersivi che contengono solventi, in quanto possono corrodere il materiale danneggiandolo.

Per la manutenzione e la pulizia degli specchi in polimetacrilato, si raccomanda di effettuare la pulizia applicando su un panno morbido detersivi specifici per il polimetacrilato su un panno non abrasivo. Non utilizzare mai la carta per pulire gli specchi in acrilico.

Plastic surfaces require periodic cleaning, which has to be carried out using a soft cloth soaked in warm water. If this operation is not effective, we suggest to use a dedicated cleaner for plastic parts. Pay attention to detergents containing solvents, as they may corrode and damage the material surface. As for cleaning and maintenance of polymethacrylate mirrors, we highly recommend to clean the surfaces using a specific detergents for methacrylate together with a non-abrasive cloth. Do not use paper to clean acrylic mirrors.

### METALLI VERNICIATI

### COATED STEEL

Una periodica pulizia della superficie contribuisce a conservare inalterato il rivestimento. Si consiglia di pulire la superficie con un panno morbido, imbevuto d'acqua. Se questo non bastasse, si può ricorrere ad un prodotto specifico non aggressivo. Prestare attenzione ai detersivi che contengono le seguenti sostanze in quanto possono corrodere il rivestimento danneggiandolo: acetone, metiletilchetone, percloroetano, toluene, tricloroetano, xilene, idrato d'ammonio, idrato di sodio.

Cleaning is to be carried out periodically since this help keep unchanged the coating. If this is not effective, we suggest to use a mild cleaner. Pay attention to following substances as they can corrode and damage the coating: Aceton, Methylethylketon, Trichlorethan, Toluol, Trichlorethan, Xylol, hydratisierte Ammonium, Natrium-Hydrat.

### ACCIAIO INOX

### STAINLESS STEEL

Una corretta e periodica manutenzione dei prodotti in metallo consente di prevenire l'ossidazione del materiale, conservando inalterato il fascino delle superfici nonostante il passare del tempo. Ci si raccomanda, a seconda del tipo di metallo da trattare, di effettuare la pulizia con un prodotto specifico. Per quanto concerne specificatamente l'acciaio inox, è prassi procedere ad una manutenzione periodica delle superfici per rimuovere polvere, calcare, sporco, etc. È opportuno però fare un distinguo tra operazioni di pulizia ordinaria e straordinaria. La pulizia ordinaria può essere svolta con una spugna non abrasiva, sciacquando con abbondante acqua, preferibilmente calda. Per prevenire la formazioni di macchie ed aloni è consigliabile asciugare la superficie con uno straccio di cotone. Ogni dieci/venti pulizie ordinarie è consigliabile effettuare una pulizia straordinaria con un prodotto specifico per inox, in spray o crema, ma comunque non aggressivo. In commercio, sono reperibili detersivi specifici di varie marche. Per entrambe le operazioni di pulizia, mai utilizzare spazzole in acciaio o la lana d'acciaio in quanto possono lasciare particelle sulla superficie, nonché graffiarla.

Proper and regular maintenance of metal products helps prevent surface oxidation, keeping the surfaces charm unchanged over time. Depending on the type of surface to maintain, we suggest to clean them periodically with a specific cleaner. As for stainless steel products, they need to be clean appropriately and periodically to remove dust, lime and dirt. As for daily cleaning operation, we suggest to clean stainless steel surfaces with a non-abrasive sponge and a mild solution, then rinse surface with warm water and wipe it with a smooth cloth. Out of ten/twenty routine cleaning operations, it is necessary to perform an extraordinary cleaning operation with a specific non-aggressive product, both creamy or spray. Several specific cleaners are also available on the market. For both ordinary and extraordinary cleaning operations, carbon steel brushes or steel wool should be avoided as they may leave particles embedded on the surface, leading to oxydation.



## PULIZIA E MANUTENZIONE DEI DISPENSER

Per poter funzionare correttamente, i distributori devono essere utilizzati con un sapone di qualità e devono essere mantenuti periodicamente. Di seguito, troverete alcuni consigli, pratici e veloci, per mantenere il prodotto in ottimo stato e sempre funzionante.

### PULIZIA ESTERNA DEL DISPENSER

I dispenser, soprattutto quelli in acciaio inossidabile, conservano un aspetto migliore nel tempo se la scocca esterna viene pulita regolarmente. Ciò impedisce la formazione di macchie ostinate o punti d'ossidazione.

Per la **pulizia di routine** è sufficiente:

- Applicare un detergente delicato sulle zone interessate e strofinare la superficie con un panno leggermente inumidito. Nel caso di dispenser in inox satinato, è consigliabile eseguire l'operazione nella direzione della satinatura;
- Risciacquare con acqua tiepida per rimuovere lo sporco, le macchie o i residui di sapone, e successivamente asciugare delicatamente con un panno morbido assorbente;
- E' consigliabile eseguire questa operazione una volta alla settimana.

Per la **pulizia straordinaria** della cover, è possibile:

- Utilizzare una soluzione con ammoniaca all'1% (N.B. fare attenzione a non rendere la soluzione troppo forte). In alternativa è possibile ricorrere ad un detergente specifico per il materiale da trattare (plastica o acciaio inox).
- Per l'applicazione del detergente, è consigliabile utilizzare un panno morbido. Nel caso di distributori in acciaio inox satinati, è possibile utilizzare anche un panno a media abrasività (ad esempio Scotch-Brite di 3M). Ad applicazione completata, sciacquare accuratamente con acqua e asciugare la superficie con un panno morbido assorbente.

## DISPENSERS CLEANING AND MAINTENANCE

In order to function properly, dispensers must be used with a quality cleaner and must be maintained periodically. Below, you will find some quick and practical tips to keep the product always working and in an excellent condition.

### CLEAN THE DISPENSER COVER

Dispensers, especially stainless steel ones, look better over time if the outer shell is cleaned regularly. This prevents the formation of stubborn stains or oxidation points.

For **routine cleaning** it is enough to:

- Apply a mild detergent to the affected areas and rub the surface with a slightly damp cloth. In the case of satin-finished stainless steel dispensers, it is advisable to perform the operation in the direction of the satin finish;
- Rinse with warm water to remove dirt, stains or soap residues, and then dry gently with a soft absorbent cloth;
- Repeat the operation daily (or more often) depending on the severity of the product to be treated.

For **extraordinary cleaning** of the cover, you can:

- Use a 1% ammonia solution, but be careful not to return the solution too strong. Alternatively, it is possible to use a specific detergent for the type of surface treated (plastic or stainless steel). Never use bleach!
- To apply the solution, it is advisable to use a soft cloth. In the case of stainless steel dispensers, especially if satin, it is also possible to use a medium abrasive cloth (for example 3M's Scotch-Brite). Once the application is complete, rinse thoroughly with water and dry the surface with a soft absorbent cloth.

STATO STATUS	AGENTE PULENTE CLEANING AGENT	METODO DI APPLICAZIONE APPLICATION METHOD
<i>Sporco, sbavature di sapone e impronte digitali; Dirt, soap smudges and fingerprints;</i>	<i>Utilizzare un detergente delicato o specifico per il materiale da trattare; Use a mild cleanser or specific detergent for the material to be treated;</i>	<i>Applicare il detergente, pulire lo sporco con un panno o una spugna per superfici lisce o strutturate. Risciacquare e asciugare. Apply the cleaner. Clean the dirt with a cloth or a sponge for smooth surfaces and a soft surface brush structured. Rinse and dry.</i>
<i>Macchie ostinate; Stubborn stains;</i>	<i>Detergente, liquido o spray, specifico per il materiale da trattare; Specific detergent, liquid or spray for the material to be treated;</i>	<i>Seguire le istruzioni fornite sulla confezione del detergente. Risciacquare o asciugare. Follow the instructions given on the detergent packaging. Rinse or dry.</i>
<i>Ruggine derivante dall'esposizione a condizioni ambientali e/o chimiche difficili; Rust resulting from exposure to chemicals and / or environmental difficult conditions;</i>	<i>Detergenti per il bagno contenenti acido fosforico + panno 3M Scotch Brite o equivalente; Bathroom cleaners containing phosphoric acid + 3M cloth Scotch Brite or equivalent;</i>	<i>Pulire la superficie come indicato sulla confezione del detergente, quindi strofinare leggermente la zona con il panno. Poi, risciacquare e asciugare. Clean the surface as indicated above, then lightly rub the area with the cloth. Clean with a suitable polish for the treated surface. Then, rinse and dry.</i>

### **PRECAUZIONI PER I DISPENSER IN ACCIAIO INOX:**

Sebbene l'acciaio inossidabile sia molto resistente all'ossidazione e alla ruggine, alcune condizioni ambientali e/o alcuni agenti chimici presenti nei comuni detersivi per la pulizia possono compromettere le superfici in inox:

- Detersivi contenenti acido cloridrico o acido muriatico rovinano l'inox;
- Residui di sapone con additivi chimici acidi possono causare scolorimento del materiale e addirittura ruggine superficiale;
- Quando l'acqua della rete contiene tanto ferro o quando negli ambienti permangono polveri o particelle di ferro, è possibile che si sviluppi l'ossidazione (ad es. schizzi d'acqua del lavandino sul dispenser, residui metallici lasciati durante l'installazione di altre attrezzature; particelle di detersivi in polvere che si depositano sul dispenser durante la pulizia della toilette, ecc.).

In questi casi è indispensabile rimuovere la ruggine/ossidazione il più presto possibile per evitare danni irreversibili alla superficie del dispenser.

### **RACCOMANDAZIONI:**

- Non pulire mai i dispenser in acciaio inossidabile con detersivi contenenti candeggina, cloruri, acido cloridrico e acido muriatico. Queste sostanze si trovano spesso nei detersivi per i WC, per le piastrelle o in generale nelle polveri abrasive.
- Non utilizzare detersivi abrasivi sulle superfici in acciaio inossidabile brillante. Preferire detersivi per inox.
- Non usare lana d'acciaio, graffierebbe le finiture.
- Non utilizzare spugne metalliche o qualsiasi altra spugna che possa lasciare particelle di ruggine sulla superficie.
- I dispenser satinati vanno puliti nella direzione della satinatura.
- Non lavare i prodotti sotto l'acqua corrente, non immergerli in acqua, soprattutto se automatici (funzionanti con batterie o adattatori).
- Non raschiare mai l'ossidazione con utensili in metallo o acciaio.

### **RIEMPIRE IL DISPENSER:**

Assicuratevi di utilizzare il dispenser con il giusto tipo di detersivo (sapone liquido o schiuma; liquido o gel igienizzante). L'utilizzo di un consumabile non idoneo al tipo di pompa installata nel dispenser, farà decadere la garanzia. Dopo il riempimento, assicurarsi di pulire sbavature o il liquido in eccesso.

### **MANTENERE PULITA L'UNITÀ INTERNA:**

Gran parte dei problemi che riscontriamo sui dispenser di sapone sono causati dal tipo di consumabile utilizzato.

**Saponi molto densi o molto concentrati** causano ostruzioni alle pompe di erogazione. Al contrario, **saponi eccessivamente liquidi o diluiti**, hanno una viscosità insufficiente e tendono a fluire con eccessiva facilità attraverso il sistema d'erogazione (effetto gocciolamento).

Un altro problema comunemente riscontrato con i dispenser di sapone è l'uso di **detersivi troppo acidi o troppo basici**. I saponi acidi (pH < 6,5) corrodono le parti metalliche interne. Anche i saponi troppo basici (pH > 8,5) possono causare danni irreparabili alle componenti plastiche, nonché irritazioni cutanee. I nostri distributori sono progettati per essere utilizzati con saponi a PH neutro.

Anche la mancanza di manutenzione può causare problemi ai meccanismi e alle valvole interne al dispenser. Se l'apparecchio non viene utilizzato per un lungo periodo, l'ugello d'erogazione può ostruirsi. Sarà necessario pulire internamente il dispenser svuotando il serbatoio per poi riempirlo con acqua calda. Fatto ciò, l'acqua andrà delicatamente pompata azionando il dispenser così da sciogliere i coaguli e rimuovere i residui di sapone.

In caso d'ostruzione estrema, è indispensabile ricorrere ad una pulizia speciale. Rimuovere il dispenser dalla parete, se possibile. Il serbatoio dev'essere smontato e svuotato. Anche la pompa erogatrice dev'essere rimossa e svuotata da eventuali residui di sapone. Tutti i componenti andranno immersi per 30 minuti in una vaschetta con acqua calda. Fatto ciò, sempre in immersione, azionare la pompa del dispenser. Il fluire dell'acqua aiuterà a rimuovere i residui di sapone più ostinato.

Una volta completata l'operazione, asciugare i componenti con un panno e re-installarli sul dispenser.

### **ATTENZIONE:**

Non inserire mai oggetti appuntiti (ad es. perni o aghi) nell'ugello d'erogazione del sapone. Ciò potrebbe causare danni irreparabili alla pompa e invalidare la garanzia.

In caso di necessità, rivolgetevi al commerciale di riferimento per richiedere il manuale d'uso del dispenser che avete acquistato.

### **ATTENTION:**

Although stainless steel is very resistant to oxidation and rust, there are some conditions in which it can be found due to the factors listed below:

- Detergents for acid chloride or muriatic acid (hydrochloric acid);
- Concentrated soap residue where chemical additives can cause discoloration and can potentially dry out and thus appear rusty;
- Environments where water has a high iron content or where there is contact with it (e.g. steel wool, processing shavings, iron residues or dust in the installation or when cleaning other products in steel) may leave a residue of rust.
- The presence of salt containing chlorides.

Remove rust or corrosion as soon as possible to avoid permanent surface discoloration and pitting.

### **PRECAUTIONS:**

- Never clean stainless steel dispensers with cleaners containing bleach, chlorides, hydrochloric acid and muriatic acid. These are often found in toilet bowls or in abrasive tiles and powders.
- Never use abrasive cleaners on a shiny stainless steel surface.
- Never use steel wool, as it would scratch the finishes.
- Never use metal sponges or any other sponge that may leave rust particles on the surface.
- In brushed dispensers, clean or wipe in the direction of the satin finish.
- Do not wash them under running water, do not immerse them in water.
- Never scrape with steel tools.

### **FILL THE DISPENSER:**

Make sure you fill the dispenser with the right type of soap, liquid, foam or disinfectant by the hands. The use of other types of liquids is not covered by our warranty. After filling, be sure to clean the liquid from the container.

### **KEEP THE INNER UNIT CLEAN:**

Most soap dispenser problems are caused by the type of consumable used. Very thick or very concentrated soaps risk causing blockages in the delivery system, so they must be diluted with water. Excessively liquid or too diluted soaps reduce the viscosity of the soap itself with the consequent ..... of the same from.

A problem commonly encountered with soap dispensers is the use of detergents that are too basic or too acidic. Our dispensers are designed to be used with neutral PH soaps. Acid soaps (PH levels below 6.5) corrode metal parts and degrade plastic components. Basic soaps (PH levels above 8.5) also cause swelling or damage to rubber and plastic parts, as well as skin irritation.

If you use good soap, internal valve problems can be caused by a lack of maintenance. If the appliance is not used for a long period of time or if the nozzle becomes clogged, the following instructions should be followed: clean the dispenser internally at regular intervals of one week by pouring only hot water into a tank and pump gently to clean the block and remove the soap residue.

In case of extreme obstruction, therefore for special cleaning, the tank must be disassembled and pumped to restore correct operation:

remove both reservoirs and the pump from the dispenser or remove the dispenser from the wall if possible. (This is possible with models in which the tank is mounted in the unit); drain all soap from the tank, then immerse the tank and pump in hot water for 30 minutes. This will help remove any clean or thick soap residue. Pump the valve at least 20 times to remove any blockages while it is still wet.

Once cleaned, rub the components with a cloth and reassemble them together or back up to the wall brackets, remembering to fasten the unit to the brackets and screws.

### **ATTENTION:**

Never try to insert a pointed object (eg a pin) into the soap spout, as it could cause irreparable damage to the pump and void the warranty.

## LEGENDA

## LEGEND



Litraggio consigliato del sacchetto  
Bag for waste bin



Sistema di chiusura  
Key lock system



Anti-vandalismo  
Vandal proof



Funzionamento automatico  
Automatic operation



Conforme al metodo HACCP  
In compliance with HACCP plan



Certificazione CNPP  
CNPP certified



Articolo per la raccolta differenziata  
Product to encourage waste separation



Alimentazione elettrica  
Electric operation



Sapone in mousse  
Foam soap



Sapone liquido  
Liquid soap



Sapone spray  
Spray soap



Insetticida  
Insecticide



Periodo di garanzia  
Warranty period



Alimentazione a batteria  
Batteries operation



Miglior rapporto qualità/prezzo  
Best value for money product



Nuovo prodotto  
New product



Finestra di livello  
Window for level check



Capienza posacenere  
Ashtray capacity



Litraggio contenitore  
Container's capacity



Litraggio contenitore  
Container's capacity



Conforme alle norme europee  
In compliance with CE regulation



Possibile utilizzo in aree esterne coperte  
Suitable for use in covered outdoor areas



Fabbricato in Europa  
Made in Europe



Fabbricato in Italia  
Made in Italy

\* Le informazioni e le immagini riportate nel presente catalogo, sono puramente indicative e non costituiscono elemento contrattuale.

\* All information and pictures given in this catalogue are purely indicative and have no contractual value.





Ufficio commerciale - Italia  
Sales department - Italy  
[info@medialinternational.com](mailto:info@medialinternational.com)  
Tel. / Ph. +39 02 90660436 (int. 1 e int. 2)

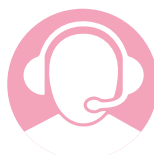

Assistenza clienti - Italia  
Customer service - Italy  
[ticketing@medialinternational.com](mailto:ticketing@medialinternational.com)  
Tel. / Ph. +39 (0)2 90660436 (int. 3)



Ufficio commerciale - Export  
Export department  
[export@medialinternational.com](mailto:export@medialinternational.com)  
Tel. / Ph. +39 (0)2 90661110



Assistenza clienti - Export  
Customer service - Export  
[ticketing@medialinternational.com](mailto:ticketing@medialinternational.com)  
Tel. / Ph. +39 (0)2 90661110



Amministrazione  
Accounts department  
[amministrazione@medialinternational.com](mailto:amministrazione@medialinternational.com)  
Tel. / Ph. +39 02 90660436 (int. 4)



Ufficio marketing  
Marketing department  
[marketing@medialinternational.com](mailto:marketing@medialinternational.com)  
Tel. / Ph. +39 (0)2 90661110



**Medial International S.p.A. a socio unico**  
C.F. e P.IVA 07834000155 / VAT NO. / TVA / USt-Id.Nr. IT07834000155  
Via Volta, 7/9 - 26837 Mulazzano (Lodi) - Italy  
Tel. +39 02 90660436 - Fax +39 02 90661441  
[www.medialinternational.com](http://www.medialinternational.com)



A series of horizontal lines for writing, consisting of 25 evenly spaced, thin grey lines that span the width of the page, providing a guide for text entry.







**MEDIAL**  
INTERNATIONAL  
**METALNOVA**









Gestione dei rifiuti e pulizia dei locali  
*Waste management & cleaning solutions*

Igiene e cura della persona  
*Hygiene and personal care solutions*

Attrezzature per spazi interni  
*Equipment for indoor areas*

Attrezzature per spazi esterni  
*Equipment for outdoor areas*



Tel. +39 02 90660436 - Fax +39 02 90661441  
info@medialinternational.com - www.medialinternational.com



Azienda con sistema di gestione qualità certificato ISO 9001  
Company certified under ISO 9001 Quality Management system

Rivenditore / Retailer